

**SJIF Impact Factor : 7.001**  
**ISI I.F Value : 1.241**

**ISSN:2455-7838 (Online)**  
**DOI : 10.36713/epra2016**



*EPRA International Journal of*  
**RESEARCH & DEVELOPMENT**  
**(IJRD)**

*Monthly, Peer Reviewed (Refereed ) & Indexed International Journal*

**Volume - 5      Issue - 7      July      2020**



### Chief Editor

Dr. A. Singaraj, M.A., M.Phil., Ph.D.

### Managing Editor

Mrs.M.Josephin Immaculate Ruba

### EDITORIAL ADVISORS

1. Prof. Dr.Said I.Shalaby, MD,Ph.D.  
Professor & Vice President  
Tropical Medicine,  
Hepatology & Gastroenterology, NRC,  
Academy of Scientific Research and Technology,  
Cairo, Egypt.
2. Dr. Mussie T. Tessema,  
Associate Professor,  
Department of Business Administration,  
Winona State University, MN,  
United States of America,
3. Dr. Mengsteab Tesfayohannes,  
Associate Professor,  
Department of Management,  
Sigmund Weis School of Business,  
Susquehanna University,  
Selinsgrove, PENN,  
United States of America,
4. Dr. Ahmed Sebihi  
Associate Professor  
Islamic Culture and Social Sciences (ICSS),  
Department of General Education (DGE),  
Gulf Medical University (GMU),  
UAE.
5. Dr. Anne Maduka,  
Assistant Professor,  
Department of Economics,  
Anambra State University,  
Igbariam Campus,  
Nigeria.
6. Dr. D.K. Awasthi, M.Sc., Ph.D.  
Associate Professor  
Department of Chemistry,  
Sri J.N.P.G. College,  
Charbagh, Lucknow,  
Uttar Pradesh. India
7. Dr. Tirtharaj Bhoi, M.A, Ph.D,  
Assistant Professor,  
School of Social Science,  
University of Jammu,  
Jammu, Jammu & Kashmir, India.
8. Dr. Pradeep Kumar Choudhury,  
Assistant Professor,  
Institute for Studies in Industrial Development,  
An ICSSR Research Institute,  
New Delhi- 110070, India.
9. Dr. Gyanendra Awasthi, M.Sc., Ph.D., NET  
Associate Professor & HOD  
Department of Biochemistry,  
Dolphin (PG) Institute of Biomedical & Natural  
Sciences,  
Dehradun, Uttarakhand, India.
10. Dr. C. Satapathy,  
Director,  
Amity Humanity Foundation,  
Amity Business School, Bhubaneswar,  
Orissa, India.



ISSN (Online): 2455-7838

SJIF Impact Factor : 7.001

ISI I.F. Value : 1.241

DOI : 10.36713/epra2016

## EPRA International Journal of Research & Development (IJRD)

Monthly Peer Reviewed & Indexed  
International Online Journal

Volume: 5, Issue:7, July 2020

Indexed By:



Published By  
EPRA Publishing

CC License





## CONTENTS

S.NO	TITLE	AUTHOR/S	PAGES
1	THE PHILOSOPHICAL AND THEOLOGICAL IDEAS ADVANCED BY CERTAIN TENDENCIES AND SCHOOLS IN SUFISM	Evatov Salimjon Sobirovich	1-3
2	DESIGN AND FABRICATION OF PORTABLE ATMOSPHERIC WATER SEQUESTRATOR AS AN OFF-GRID WATER SYSTEM <a href="https://doi.org/10.36713/epra4745">https://doi.org/10.36713/epra4745</a>	Lorenz E. Borromeo	4-9
3	PROCESSOR MEANS FOR THE SPECTRAL ANALYSIS OF MEDICAL SIGNALS ON THE OF POLYNOMIAL WALSH BASES	Rakhimov Bakhtiyar Saidovich, Allabeganov Odilbek Rakhimovich, Saidov Atabek Bakhtiyrovich	10-11
4	TRADE UNION PRACTICES IN AN INDIAN BATTERY INDUSTRY: A STUDY <a href="https://doi.org/10.36713/epra4739">https://doi.org/10.36713/epra4739</a>	Panthula Sree Sai Pavan, Prof.G.L.Narayanappa	12-15
5	LONG-TERM RESULTS OF TREATMENT OF PYELONEPHRITIS IN PREGNANT WOMEN	Odilbek Razzaqberganovich Otajonov, Gulnora Odilbekovna Razzaqberganova	16-19
6	MODELING AND PROJECTION OF NEW HIV INFECTIONS IN CHILDREN AGED BETWEEN 0 AND 14 YEARS IN ZIMBABWE USING BOX-JENKINS ARIMA MODELS	Dr. Smartson. P. NYONI, Mr. Thabani NYONI	20-33
7	ANALYZING ROAD TRAFFIC ACCIDENT RELATED TRAUMA CASES AT KWEKWE GENERAL HOSPITAL IN ZIMBABWE: EMPIRICAL EVIDENCE FROM A BOX-JENKINS SARIMA MODEL	Dr. Smartson. P. NYONI, Mr. Thabani NYONI	34-45
8	A STUDY TO ASSESS THE LEVEL OF KNOWLEDGE REGARDING ORAL HYGIENE AMONG ADULTS IN JAYAM DENTAL CARE AT PERPERIYANKUPPAM, CUDDALORE DISTRICT	Dr.K.Vignesh B.D.S, Mr.K.Jayaprakash M.Sc (N), Mr.A.Anthonisamy M.Sc (N)	46-52
9	DESIGN, ANALYSIS AND COMPARISON OF VARIOUS MATERIALS FOR CONNECTING ROD <a href="https://doi.org/10.36713/epra4760">https://doi.org/10.36713/epra4760</a>	Sumant R Balli, Prajwal Shetty, S.C.Sajjan	53-61
10	HISTORY OF CREATION SOVIET OF KARAKALPAK STATEHOOD <a href="https://doi.org/10.36713/epra4776">https://doi.org/10.36713/epra4776</a>	Djumashev A.	62-64
11	CURRENT STATE OF STUDY AND USE OF MATERIALS OF THE ORENBURG EXPEDITION IN HISTORIOGRAPHY	Saparniyazov A.	65-67

	<a href="https://doi.org/10.36713/epra4777">https://doi.org/10.36713/epra4777</a>		
12	SEMANTICS AND STRUCTURE OF COMPLEX WORD COMBINATIONS IN THE CONTEMPORARY KARAKALPAK LANGUAGE <a href="https://doi.org/10.36713/epra4733">https://doi.org/10.36713/epra4733</a>	Opaeva Raygul Aymanovna	68-71
13	HISTORY OF FOREIGN LANGUAGE EDUCATION IN KARAKALPAK SCHOOL <a href="https://doi.org/10.36713/epra4765">https://doi.org/10.36713/epra4765</a>	Bekjanova Ainura Markhabaevna	72-75
14	A SURVEY OF THYROID DETECTION USING DATAMINING TECHNIQUES	A.Vinitha	76-78
15	INVESTIGATION OF PEA POD CHEMICAL CONSTITUENTS RESPONSIBLE FOR WATER TREATMENT	Muhammad Muhammad Makki, Dr. Osama Mohamed Ahmed Adam, Prof. Salih Elhadi Mohamed Ahmed	79-82
16	THE ECONOMIC GROWTH FORECAST AND A REVIEW OF THE IMPACTS OF COVID-19 ON THE GHANAIAN ECONOMY: APPLICATION OF TIME SERIES ANALYSIS AND MONTE-CARLO SIMULATION <a href="https://doi.org/10.36713/epra4427">https://doi.org/10.36713/epra4427</a>	Professor Li Fang Lin, Blessed Kwasi Adjei, Felix Kwame Nyarko	83-95
17	JOURNALISTIC SKILLS IN MODERN JAPANESE RECREATIONAL TV SHOWS	Khalilova Aziza Shamuhutovna	96-100
18	IMPORTANCE OF ATTENTION IN PRESCHOOLERS' COGNITIVE DEVELOPMENT TO PROGRESS ACADEMIC PERFORMANCE	Iminova Xumora Mukhammadisa kizi	101-103
19	THE BEGINNING OF THE EUROPEAN RENAISSANCE <a href="https://doi.org/10.36713/epra4787">https://doi.org/10.36713/epra4787</a>	Mahmudov Otabek	104-108
20	SUBJECT OF INNOVATION ACTIVITY – DEFINING ELEMENT OF MODERNIZATION OF THE SOCIETY	Khakimov Erkin Tuychiyevich	109-112
21	POLITICAL ACTIVITY OF USMON HOJA POLATHOJAEV IN THE YEARS OF BPSR (1920-1924)	Akmal Mahmudov Mannonjonovich	113-116
22	PRACTICES OF INDUSTRIAL RELATIONS IN AN INDIAN SUGAR INDUSTRY: AN EMPIRICAL STUDY <a href="https://doi.org/10.36713/epra4751">https://doi.org/10.36713/epra4751</a>	Ms. N.Anupama, Prof.G.L.Narayanappa	117-119
23	OPPORTUNITIES AND CHALLENGES ON CONSERVATION OF AMBATARA PROTECTED AREA, SEDE MUJA DISTRICT, ETHIOPIA <a href="https://doi.org/10.36713/epra4822">https://doi.org/10.36713/epra4822</a>	Haile Zerfu Munaw	120-130
24	EVALUATION OF INNOVATION CAPACITY RESOURCE COMPONENTS IN EFFECTIVE MANAGEMENT OF RECREATIONAL CLUSTERS ON THE BASIS OF ECONOMETRIC ANALYSIS <a href="https://doi.org/10.36713/epra4790">https://doi.org/10.36713/epra4790</a>	Mirzaev Abdullajon Topilovich	131-137
25	THE ROLE OF EUPHEMISMS IN TEACHING	Feruza Mamatova Bakhtiyorovna	138-145
26	IMPACT OF URBANIZATION ON SOCIO ECONOMIC STATUS OF AGING A CASE STUDY OF JORHAT DISTRICT OF	Himanshu Gogoi	146-162

	ASSAM <a href="https://doi.org/10.36713/epra4778">https://doi.org/10.36713/epra4778</a>		
27	A CASE STUDY ON CREATING CUSTOMER VALUE IN SUPPLY CHAIN MANAGEMENT <a href="https://doi.org/10.36713/epra4794">https://doi.org/10.36713/epra4794</a>	Dr. Navneet Joshi, Sanjive Saxena	163-167
28	THE IMPACT OF EXCHANGE RATE VOLATILITY ON ECONOMIC GROWTH IN ECOWAS MEMBER COUNTRIES (2000-2018)	Phebe Padolo Moye	168-180
29	AUDIT FEES AND AUDIT REPORT LAG	Dr. Patrick Amaechi Egbunike, Peace Asuzu	181-187
30	PECULIARITIES OF STRUCTURAL CHANGES IN THE MACHINE-BUILDING INDUSTRY OF UZBEKISTAN <a href="https://doi.org/10.36713/epra3871">https://doi.org/10.36713/epra3871</a>	Khaydarov Khayrulla Gulamovich	188-193
31	THE OCTOBER REVOLUTION OF 1917 AND THE ESTABLISHMENT OF SOVIET POWER IN THE TURKESTAN TERRITORY	Baxtigul Abdupattaevna Mamadaminova	194-196
32	ORGANIZATIONAL STRUCTURE AND LEGAL BASIS OF RADIO BROADCASTING IN UZBEKISTAN (1927-1980)	Temirova Mashxura Muhammadaminovna	197-204
33	NARRATIVE THEORY-TEXT AS AN OBJECT OF RESEARCH IN NARRATOLOGY	Hamroyeva Farida Fakhriddinovna	205-207
34	THE IMPRESSION OF CORPORATE SOCIAL RESPONSIBILITY (CSR) ON CORPORATE FINANCIAL PERFORMANCE (CFP) AND THE CONCEPT AND ROLE OF AGENCY THEORY	Faria Rahman, Payal Pandey	208-216
35	THE IMPORTANCE OF E-GOVERNMENT AND MASS MEDIA (As an example of the People's Republic of China)	M. Siddikova	217-221
36	RHETORIC IN THE ENGLISH AND UZBEK LANGUAGES	Khushnuda Batirovna SAMIGOVA, Farkhod Khabibullayevich ABDULLAYEV	222-233
37	THEORETICAL AND ECONOMIC PREREQUISITES FOR THE DEVELOPMENT OF REGIONAL INDUSTRIAL CLUSTERS IN THE ECONOMY OF THE REPUBLIC OF UZBEKISTAN <a href="https://doi.org/10.36713/epra4855">https://doi.org/10.36713/epra4855</a>	Khankeldieva Guzal Sherovna	234-240
38	NOISES OF ELECTRONIC DEVICES (GENERAL INFORMATION, SOURCES) <a href="https://doi.org/10.36713/epra4857">https://doi.org/10.36713/epra4857</a>	Gulkhayo Oybekovna Akbarova	241-245
39	TEACHING ENTREPRENEURSHIP REDIRECT FOR YOUNG PEOPLE IN MODERN CONDITIONS <a href="https://doi.org/10.36713/epra4858">https://doi.org/10.36713/epra4858</a>	Makhliyokhon Madaminjonovna Mirzakarimova	246-249
40	A STUDY ON PERFORMANCE APPRAISAL MEASURES WITH REFERENCE TO ANIMATION INDUSTRY	Dr. Vanaja.V, Radhika.V	250-256
41	BLOCKCHAIN METHOD IN	Makhmudov Abdukhalil	257-259

	DEVELOPMENT OF DIGITAL ECONOMY		
42	DETERMINATION OF THE EFFICIENCY OF USING THE COOLING SYSTEM IN SOLAR PHOTOELECTRIC CONVERTERS	S.F. Ergashev, D.R.Otamirzaev	260-264
43	THE PROBLEMS OF USING THE CASE-STUDY METHOD IN THE STUDY OF SOCIAL PROBLEMS OF CHILDREN WITH DEFICIENT MENTAL DEVELOPMENT	F.O.Kamilov	265-268
44	SOCIAL STRATIFICATION OF PEASANT FARMS IN UZBEKISTAN IN THE FIRST YEARS OF THE NEW ECONOMIC POLICY	Mahmudov Mahmudkhon	269-273
45	THE PRAISE OF NATURE AND THE UNIVERSE IN NOVALIS ROMANCE	Urakova Oysuluv Jamoliddinovna	274-276
46	CRIME ANALYSIS AND PREDICTION USING K-MEANS CLUSTERING TECHNIQUE	Wasim A. Ali, Husam Alalloush, Manasa K.N.	277-280
47	A MODERN APPROACH TO SHAPING THE ENTREPRENEURIAL CULTURE OF YOUNG PEOPLE	Jurayev Luqmon Narzilloyevich	281-283
48	PROBLEMS OF ATTRACTING FOREIGN INVESTMENT INTO THE NATIONAL ECONOMY	Goolbahor Abdusattarovna Karimova	284-287
49	USAGE PATTERN OF LIBRARY RESOURCES BY THE FACULTY MEMBERS OF NAAC ACCREDITED DEGREE COLLEGES IN KADAPA DISTRICT: A STUDY <a href="https://doi.org/10.36713/epra4841">https://doi.org/10.36713/epra4841</a>	Mr.M.V.Krishna Reddy, Dr.M.Anjaiah, Dr.M.Doraswamy	288-293
50	THE IMPACT OF ENVIRONMENTAL PERFORMANCE AND THE PER CAPITA GROSS DOMESTIC PRODUCT ON GREEN ECONOMY: AN EMPIRICAL INVESTIGATION	Tharindu Udayanga Kamburawala	294-298
51	COVID-19 AND INDIA'S FOREIGN TRADE: AN EMPIRICAL ANALYSIS OF SELECT COMMODITIES	Rohan Prasad Gupta	299-307
52	HOUSEHOLDS FUELWOOD CONSUMPTION IMPACT ON FOREST DEGRADATION IN THE CASE OF MOTTA DISTRICT, NORTHWEST ETHIOPIA <a href="https://doi.org/10.36713/epra4763">https://doi.org/10.36713/epra4763</a>	Mulatu Mengist	308-315
53	IN THE EYES OF THE BEHOLDER: STUDENTS' PERCEPTION OF STUDENT-TEACHERS CLASSROOM BEHAVIOUR AND COMPETENCIES IN ABIA STATE	Udechukwu, Jonathan (Ph.D). Kanelechi C.K. Nwangwa (Ph.D)	316-324
54	ETHNOGRAPHIC STUDIES ON THE HISTORY OF THE LEFT-BANK KAT-QALA: MYTHS AND LEGENDS	Sadullaev B.P.	325-329
55	A STUDY ABOUT PADDY FARMER PRODUCER COMPANIES IN KUTTANAD (2016-2019)	Aby George	330-338
56	MICRO FINANCE AS A TOOL FOR ERADICATION OF POVERTY	Pallavi Sarma	339-343





# THE PHILOSOPHICAL AND THEOLOGICAL IDEAS ADVANCED BY CERTAIN TENDENCIES AND SCHOOLS IN SUFISM

**Evatov Salimjon Sobirovich**

*Ferghana State University, The teacher of the department of Civil Society, Fergana, Uzbekistan,*

## ANNOTATION

*The article examines the relationship and differences between the philosophical and theological ideas put forward by the representatives of mystical movements formed in Central Asia and Khorasan with the major philosophical currents of antiquity.*

**KEYWORDS:** *mysticism, philosophy, theology, universe, Allah, Aristotelianism, Platonism, Neoplatonism, enlightenment, infinity, spiritual maturity.*

## DISCUSSION

In their works, Sufi philosophers sought to reconcile and unite the various ideological and philosophical currents in any way. In early medieval mysticism, there was a philosophical school called the “masha”. This school was further refined by the followers of Aristotle. Many philosophers, including Farabi and Ibn Sina were followers of this school. The philosophy is named after Aristotle’s habit of walking around the classroom while teaching his students. The word walking in Arabic is called “masha”, hence the name of the school was taken by the word. From this philosophical point of view, man can acquire truth only through contemplation and analysis and only if his mental ability is properly used in the study of the environment, reality and truth. The philosophy of “Masha” encompasses the whole of existence, including Allah, man and the universe. [1].

At the same time, there was another philosophical school called “Ishrok”. The founder of this school was Shahobiddin Suhrawardi. Sheikh Suhrawardi, after many years of research, came to the conclusion that all living things came into being from light and radiate light from themselves and illuminate each other. He called this interaction “Ishrok”. He was later renamed with the name Sheikh Ishrok. Ishrok is the most important theory of Islam, based on the teachings of the Koran on the one hand, and the philosophical school of Plato on the other, and the new Platonism.

According to this theory, the whole universe are made of light, and there was no universe but light. According to Suhrawardi’s teaching, “radiation” is the basis of existence and has different stages. Radiation becomes weaker or stronger, and the universe is nothing more than the mutual scattering of light.

Shahabuddin Suhrawardi also called man a light, and in this way he believed that man could be necessary, useful and illuminated by the light of others.

According to the “Ishrok” philosophy, we see only those things that radiate light. Excessive radiation can damage the eyes and even may make blind a person. Suhrawardi considers Allah to be the highest light and man cannot observe such a powerful light. Everything receives its ability to illuminate from this Supreme Light. According to this philosophical school, the interaction between the lights takes place in two states: in the state of hatred and in the state of love. In the case of poor eyesight, each higher light dominates the lower light. In love, each of the following lights falls in love with and obeys the higher light[2].

In connection with the analysis of the above-mentioned philosophical schools, it is useful to get acquainted with the activities of some of their prominent representatives.

One such philosophical school was called the “Higher Philosophy”. The founder of this school was Mulla Sadriddin Sherozi, who was born in 1571. He struggled relentlessly with outdated thoughts. The



“Supreme Philosophy” which was developed by this sage is only concerned with reconciling rational philosophy with theological philosophy. In the philosophical school founded by Mulla Sadr Shirazi, he combined these two philosophical systems, combining the philosophy of “masha” based only on intellectual conclusions and the philosophy of “ishrok” based on the theory of mutual enlightenment, in which the elements of mysticism and mystical concepts, he also cited many commentaries from the Koran as proof of his theory. He struggled relentlessly with outdated thoughts. The Supreme Philosophy, developed by this sage, is only concerned with reconciling rational philosophy with theological philosophy. Mulla Sadr created a new philosophical current. “Of course, many philosophical truths have been discovered by other philosophers, but his service is in the correct application of these truths”, [3]- writes F. Rosenthal.

In Islamic religious philosophy, especially in the ontological philosophy of mysticism, “light” has always been one of the central (most important) concepts. The term “enlightenment” is a reflection of the concept of ignorance, a figurative expression of knowledge.

In the darkness, in the darkness, we cannot see anything, we remain ignorant. But in the light of day, we do not go astray, we gain knowledge. This simple human experience was transformed into the realm of the mind and spirit from the earliest times. Light was a figurative concept of emotional perception, of intellectual (mental) perception of the universe. Its original source is Allah, who in any case does not need another source of light because he is light and who illuminates everything else in due proportion. For Plotinus, just as pure light is the highest perfection in the world of the mind, Suhrawardi built a smooth cosmological system based on the light of the light he created from time immemorial. Sufis used the works of Christian theologians who described cognition as enlightenment. But the Sufis are far ahead of them[4]. Their minds were flooded with symbols of different forms of light. It is as if the Prophet (peace and blessings of Allah be upon him) said in his prayer: Ya Allah! Let there be light above me, let there be light beneath me, in front of me and behind me. My Allah, enlighten my heart, enlighten my eyes, enlighten my ears, enlighten my body, enlighten my bones[5]. Here the spiritual knowledge of any real world is described as the light, the enlightenment, which is attained by one who is thirsty for any knowledge.

The Sufis were ready to describe any desire as light. Hakim Termizi believes that there is a certain enlightenment in every word that is uttered in supplication to Allah. But in mysticism, the phrase “knowledge is enlightenment” is used less than the

phrase “faith enlightenment”. Faith is the light in the heart, and faith is the true source of enlightenment. “Sufis learn whatever they want, thinking that it will bring them understanding and faith”, - Termizi wrote. “Intelligence, knowledge, purity of heart, fear of Allah - all these concepts have been transformed into a whole without any significant mental differences.”[6].

The great scholar Ibn Arabi (1165-1240) made a great contribution to the development of the theory of Sufism. Born in Andalusia, he spent his life traveling to various Muslim cities and interacting with educated people. He was the greatest theorist of Sufism and the author of more than 300 works. In Ibn Arabi's works, especially “Fusul al-hikam”, “Futuxat al-makkiya”, “Tarjimon al-ashvak”, as a Sufi thinker, the unity of the universe and Allah, the pursuit of it and achieving the attainment of it through “inner experience”, the teachings of the Koran is symbolic holly book. His contribution to the comprehensive development of Sufi cosmogony is particularly noteworthy.

Ibn Arabi's historical contribution to the development and popularization of mystical ideas is significant. Imam Gazzali proved to the scholastics that mysticism was not kufr and reconciled mysticism with Islam. It is Ibn Arabi's job to create mystical literature and arouse interest in its study. He told people to feel the spirit of mysticism, they were to help them discover mysticism through their existence and activities, regardless of their traditions. Ibn Arabi's philosophical and literary legacy is rich and varied. Some of his works are intended for those who are able to think about ancient mythology, its concepts and expressions. Others are associated with Christianity and serve as an Islamic, Sufi guide for people raised in a Christian environment.

The true meaning of some of Ibn Arabi's thoughts (phrases) is astonishing. In the book “Donishmandlik qirralari”, he says that one should not try to see Allah in any intangible form. It is perfect for Sufis to see Allah as a poet in the form of a woman” and made poems for her perfection.[7]. It is believed that the poetry of love (poem) is able to perform many other functions at the same time and to express the knowledge of divinity in the most consistent and perfect way. Addressing theologians who are accustomed to explaining everything about religion in a rigid way, Ibn Arabi said like that, “Angels are a power hidden within the abilities of human organs”. The goal of Sufis is to increase the activity of these members.

Like other Sufis, Ibn Arabi is a religion, each of which is officially accepted and the inner understanding of this religion, which leads man to enlightenment, states that there is a fully acceptable interrelationship.





The proponents of theological education are disagree this point of view. Because their reputations were based, to a certain extent, on hardened factors, historical materials, and methods of persuasion. Ibn Arabi, like other Sufis, understood that the beauty of man is a divine being, enlightened. Therefore, he not only sang the perfection of an adult girl, but also managed to create poems that express the idea of higher existence in a unique way. But seeing and acknowledging such a connection was vehemently denied by the orthodox Sharia nation, who openly considered themselves ashamed. [8].

Ibn Arabi defended polytheism with particular caution. At a time when any believer is right in his deity, only the Gnostics, who are able to know that Allah existed in the beginning and that it is an extraordinary event, his mistakes are attributed only to the absolute Allah, that he worships its oneness.

The difference between polytheism and monotheism is the difference between plurality and unity. The polytheist is incapable of understanding the unity of the whole and considers the indivisible to be divisible. But any object of worship is Allah, the divine aspect of the object of worship being manifested, ultimately as Allah's himself.

Sufis advocate the existence of polytheism if there is divine love at its core, if the pagans recognize that their idols are a form, not a hidden essence of divinity, if people have created different beliefs, I can embrace them all with one glance, says the great sheikh.

Ibn Arabi's views had a great influence on the further development of mysticism, which was refined many times and in various forms by Sufi teachers (sheikhs) and poets.

Ibn Arabi classified the idea of polytheism, which in his time afflicted Maarri and caused his distrust, put forward the idea of the existence of different denominations and put an end to mistrust. It was a proof of the unity of being and the comprehensive immanence of Allah. In keeping with the strict requirements of the existing religious doctrine, the ideas of the universal-mystical religion were characterized by such ideas as religious tolerance, respect for other religious pursuits, and recognition of the values of other cultures.

The Sufis claimed that belief in Allah was not once the achievement of the mind. This belief is rooted in human nature and does not change under the influence of the mind or the environment. No matter how hard a person tries, he is not able to know the attributes of Allah. Rationalists (intelligences) think that truth can only be achieved through logic. Mystical Sufis claim that this truth can only be achieved through intuition.

On the one hand, the Sufis portrayed Allah with non-human attributes and distanced him from

his creation to such an extent that the question arose as to how he would affect the being he created. On the other hand, they came to the conclusion that the universe could be gradually absorbed into Allah, and logically came to the conclusion that Allah is everything.

## REFERENCES

1. Al Khomeyni. *The path to truth*. - Tehran: Publishing Production of Imam Khomeini International Branch, 2003.-32 p.
2. *Islam Encyclopedic Dictionary*. - Moscow: Science, 1991.- 215 p.
3. Rosenthal F. *The triumph of knowledge. The concept of knowledge in medieval Islam*.- Moscow: Science, 1978.-164 p.
4. Al Khomeyni. *The path to truth. Elected Imam Khomeini Int. Department of Tehran*, 2003. - 33 p.
5. Al Khomeini. *The path to truth. Elected Imam Khomeini Int. Department of Tehran*, 2003. - 33 p.
6. Rosenthal F. *The triumph of knowledge. The concept of knowledge in medieval Islam. M.: Nauka, 1978.-- 166 p.*
7. Shah I. *Sufism*. - Moscow: Kalashnikov, Komarov. K., 2004.-168 p.
8. Shah I. *Sufism*. - Moscow: Kalashnikov, Komarov. K., 2004.-173 p.



# DESIGN AND FABRICATION OF PORTABLE ATMOSPHERIC WATER SEQUESTRATOR AS AN OFF-GRID WATER SYSTEM

Lorenz E. Borromeo<sup>1</sup>

<sup>1</sup>Researcher, Department of Chemical Engineering, Bicol University – Legazpi City, Philippines

Article DOI: <https://doi.org/10.36713/epra4745>

## ABSTRACT

The lack of access to clean water has been one of the major issues in water-stressed countries. In this study, the design and fabrication of a prototype portable atmospheric water sequestrator device was carried out and tested for its ability to harness available water vapor in the atmosphere. The system utilized the concept of Peltier effect in Peltier units as a new way to liquefy atmospheric water. MATLAB® was used to investigate effects of different parameters namely humidity ratio, volumetric air flow rate, and Peltier surface temperature on water generation. Results showed that humidity ratio exhibited the highest significance among the parameters. Furthermore, the highest water production was found to be 7.643 mL at a Peltier surface temperature of 4 °C, air flowrate of 24 ft<sup>3</sup>/min, and humidity ratio of 0.021. Moreover, the physico-chemical characteristics of the water produced was well under the Philippine standards and can be classified into Public Water Supply Class I.

**KEYWORDS:** Design and fabrication, portable water sequestrator, Peltier effect, water generation

## 1. INTRODUCTION

The current need for clean water has been one of the major issues that must be addressed not only in the water-stressed countries, but also in the entire world. According to the recent statistical records provided by United Nations Educational, Scientific, and Cultural Organization (UNESCO), at least 663 million people across the globe still do not have access to clean and safe water<sup>[1]</sup>. In the Philippines, the same issue is being experienced by those situated in rural areas, thus resulting to around 6,000 deaths per year caused by water-borne diseases found in poor water quality. Hence, searching out ways to obtain clean water easily are some of the most vital international dialogues as these can change the lives of millions of people especially those situated in poor countries.

Water can be harnessed from different sources such as surface water, ground water, or seawater. However, the presence of enormous number of contaminants requires stringent water treatment, which utilizes treatment chemicals, to meet existing water standards. The widespread use of these

treatment chemicals may potentially cause hazardous side effects if taken in excess<sup>[2]</sup>. Moreover, the increasing number of water filtration stations in the Philippines has taken the advantage of extracting groundwater and processing it to become clean and potable. A major drawback of these water stations is the bulky and huge equipment on which these facilities operate with, thus entailing difficulty in transporting into less accessible places where the need is great<sup>[3]</sup>.

Developing new ways of harnessing clean water, aside from those conventional ones, without harming the public health and environment have been of great interest. Tapping another hidden reservoir of water, which is the atmosphere, is one of the compelling ways in the new era<sup>[4]</sup>. With the enormous water volume it contains, harnessing it is of a significant way to further improve the status of clean water worldwide.

In this work, a prototype portable atmospheric water sequestrator (PAWS) was designed and fabricated. Peltier units were integrated in the system as an alternative cooling technology and investigated



its capability to transform available atmospheric water vapor to a liquified form. The effects of different parameters namely on-site humidity ratios, volumetric air flow rates, and Peltier surface temperatures on water production were investigated. Moreover, primary physico – chemical parameters namely total dissolved solids (TDS), turbidity, color, odor, pH, total hardness, and chloride concentration were used to characterize the water generated by

PAWS and compared it with existing water standards in the Philippines.

## 2. METHODOLOGY

### 2.1. Materials

All materials used for fabrication were locally sourced in the Philippines. The list of materials is shown in Table 1.

**Table 1. List of Materials for the Fabrication of PAWS**

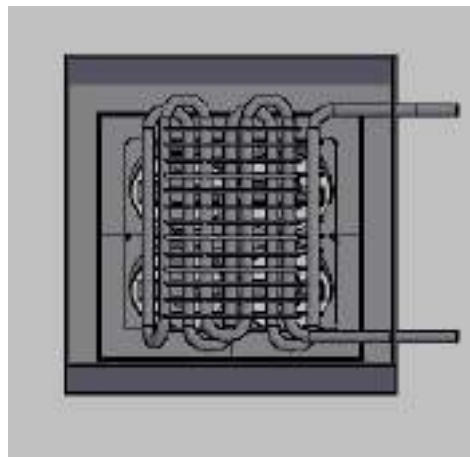
Materials	Pieces
TEC – 12706 Peltier Units (4 x 4 cm)	4
Aluminum Heat Sinks (4.5 x 5 in)	1
Potentiometers	2
Water Pump (4 L/min)	1
Air Fan (80 mm)	4
Aluminum Sheets (1 x 1 m)	1
Copper Tubing (3/8 in.)	1
Plastic (Tygon) Tubing	1
High-Temperature Sealant	1
High-Grade Thermal Paste	2

## 2.2. Design Considerations

### 2.2.1. Design of Air Fan Heat Exchanger System

A rough scale down was implemented during construction of the air fan heat exchanger system. The study of Kadhim and his colleagues in 2016 was

used as the design basis<sup>[5]</sup>. A 150 mm x 150 mm air fan heat exchanger with 8 tube passes was fabricated using smooth copper tubes. Modification on the last four passes were carried out in window positions relative to the last four passes to maintain portability and increase air and coolant turbulent flow formation.

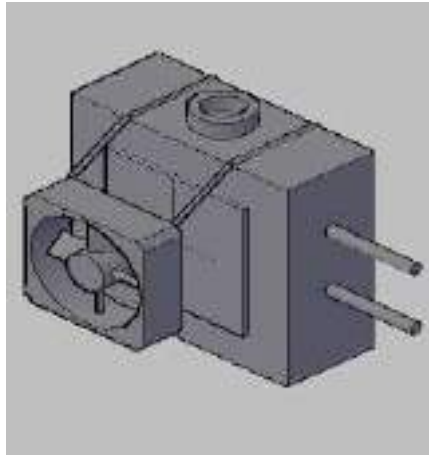


**Figure 1. Front view of the air fan heat exchanger system of PAWS**

### 2.2.2. Design of Coolant Tank

The coolant tank was designed to have an overall dimension of 127 mm x 127 mm x 51 mm. A heat sink of dimension 127 mm x 127 mm x 25 mm was attached inside the coolant tank to easily dissipate the heat coming from the attached Peltier units into the

coolant water. Two holes fitted with copper tubing were made to accommodate the circulation of the coolant water from the tank to the heat exchanger.

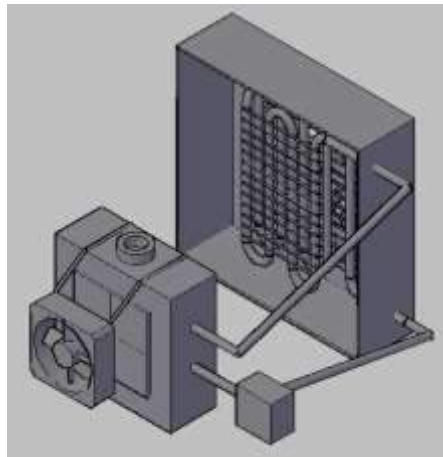


**Figure 2. Coolant tank design of PAWS**

### 2.2.3. Full Set-Up

The overall set – up consisted of two (2) main parts; the coolant tank on which Peltier units were attached and the air fan heat exchanger system. The Peltier units were attached to the exposed area of the heat sink in the coolant tank. Meanwhile, an 80 mm fan was installed in front to blow air directly on the Peltier units. Both the coolant tank and the heat exchanger system were connected using plastic

tubing to direct the circulation of the coolant water from the coolant tank to the air fan heat exchanger and vice versa. The coolant was recirculated from the tank to the heat exchanger with the use of a mini direct current (DC) water pump. The water generated on the Peltier's surfaces was collected using a drip tray situated underneath the Peltier units.



**Figure 3. Full Set-Up of Portable Atmospheric Water Sequestrator**

### 2.3. Experimental Runs

The device was operated on different days at different times to achieve desired relative humidity and temperature conditions. A sensitive hygrometer was used to measure the actual relative humidity and temperature of the surroundings. For the modifications of the volumetric air flow rate, the blade speed of the fan in front of the Peltier units was adjusted based from the entering current. A 500 ohm potentiometer was used to regulate the current flow of the fan. The same principle was followed for the

regulation of the cold facial temperature of the Peltier units using a 5000 ohm potentiometer.

Each experimental run was operated for 3 hours in a collection elevation of 1 m above ground. The constant electrical supply was provided by a 12 A AC – DC converter. A separate converter was used for the regulation of the blade speed of the fan in front of the Peltier units. The entire batch experimentation ran for 57 hours.

The investigation of the performance of the device to harness water vapor was carried out using



predetermined values of on-site humidity ratio (0.017 kg water/kg dry air, 0.019 kg water/kg dry air, 0.021 kg water/kg dry air), volumetric air flow rate (10 ft<sup>3</sup>/min, 17 ft<sup>3</sup>/min, 24 ft<sup>3</sup>/min), and Peltier surface temperature (4 °C, 12 °C, 20 °C). Experiments were performed with total of 19 runs with parameter values generated through response surface methodology (RSM) by MATLAB®.

#### 2.4. Physico – Chemical Analyses

The physical and chemical characterization of the condensate collected from the atmospheric water sequestrator was carried out to classify its quality based from the standards set by the Philippine

National Standards in Drinking Water (PNSDW). Samples were sent to Metropolitan Naga Water District, an accredited water testing center in Naga City, Philippines, to quantify values of pH, color, odor, total dissolved solids (TDS), turbidity, chloride, and total hardness (as CaCO<sub>3</sub>) concentrations.

### 3. RESULTS AND DISCUSSION

#### 3.1. Water Generation

Operating conditions generated by MATLAB® were followed to quantify the water generated by PAWS. The water generation response of PAWS is shown in Table 2.

**Table 2. Water Generation Response of PAWS**

Runs	HR <sup>a</sup> (A)	AF <sup>b</sup> (B)	PST <sup>c</sup> (C)	Generation <sup>d</sup>
1	0.019	17	12	6.5
2	0.019	17	12	6.8
3	0.019	17	12	6.6
4	0.019	17	12	6.6
5	0.019	17	12	6.4
6	0.017	10	4	5.5
7	0.021	10	4	6.8
8	0.017	24	4	5.9
9	0.021	24	4	7.6
10	0.017	10	20	5.6
11	0.021	10	20	6.6
12	0.017	24	20	5.6
13	0.021	24	20	6.7
14	0.017	17	12	5.7
15	0.021	17	12	7.5
16	0.019	10	12	6.3
17	0.019	24	12	6.7
18	0.019	17	4	6.8
19	0.019	17	20	6.4

<sup>a</sup>Humidity ratio (kg water/kg dry air)

<sup>b</sup>Air flowrate (ft<sup>3</sup>/min)

<sup>c</sup>Peltier surface temperature (°C)

<sup>d</sup>Water generation (mL)

The mathematical correlation among the operating parameters can be represented by the model equation below

$$\text{Water generated} = -8.5961 + 0.18173C + 0.089463B + 1053.74A - 2.46 \times 10^{-3}CB - 7.03125CA + 4.46429BA - 1.15 \times 10^{-3}C^2 - 3.55 \times 10^{-3}B^2 - 18427.8A^2 \quad (1)$$

Where A is the humidity ratio (kg water/kg da), B is the air flowrate (ft<sup>3</sup>/min), and C is the Peltier surface temperature (°C).



### 3.2. Optimal Operating Condition

Using Design Expert®, the optimal conditions on which PAWS can be operated was determined. A set of randomized runs were done to effectively point out

the highest water produced based on the model generated. The results are shown in Table 3.

The air flow rate must be operated at 24 ft<sup>3</sup>/min, at a humidity ratio of 0.021 while maintaining a surface temperature of 4 °C. The maximum volume of water recorded at this condition was 7.643 mL.

**Table 3. Optimum Parametric Values for Water Generation**

HR <sup>a</sup> (A)	AF <sup>b</sup> (B)	PST <sup>c</sup> (C)	Generation <sup>d</sup>
0.021	24	4	7.643

### 3.4. Physico-chemical Characterization

The results of the physico-chemical characterization were shown in Table 4. The values

were compared to the existing drinking water standards set by Philippine National Standards for Drinking Water (PNSDW).

**Table 4. Physico-chemical Characteristics of the Water Generated by PAWS**

Parameter	Unit	Tested	PNSDW
Total Dissolved Solids (TDS)	mg/L	42.2	500
Turbidity	NTU	0.43	5
Power of Hydrogen (pH)	-	7.7	6.5-8.5
Chloride Concentration	mg/L	34.5	250
Color	TCU	1 TCU	True; 5 Color Units
Odor	-	Unobjectionable	No objectionable Odor
Total Hardness (CaCO <sub>3</sub> ) Concentration	mg/L	19	300

#### 3.4.1. Total Dissolved Solids

The total dissolved solids (TDS) refer to all ions dissolved in water. The composition of which is mainly inorganic salts and some small amounts of organic matter that are dissolved in water. The resulting TDS concentration was measured at 42.2 mg/L, well within than the PNSDW standards. This could be explained by the natural chemical composition of the air which is mainly affected by human activities. Pollutants found in air could be traced from fuel combustion of automobiles and anthropogenic activities on a daily basis. These emitted pollutants are transported by winds. In highly populated cities (urban), these compounds are thoroughly distributed in the air<sup>[6]</sup>. Indoor air pollutants could be sourced from plant and animal bioaerosols and minerals, combustion, and home or

personal care aerosols. These can be produced indoors or enter the house through openings<sup>[7]</sup>.

#### 3.4.2. Turbidity

Turbidity is a measure of the amount of light that is being scattered by particulates present in water. These particulates include divided inorganic and organic matter, soluble colored organic compounds, and other microscopic organisms. Some of the particles which causes turbidity are from the particle-microorganism complexes. The microorganisms of concern include pathogenic protozoa and bacteria which are commonly found in atmospheric water<sup>[8]</sup>.

Based from the cited sources, the turbidity in the harnessed water is due to the presence of fecal coliforms, total coliforms, and other dissolved ions. These microorganisms form matrix on smaller particles or ions present in the water causing the light





to be scattered. However, the value indicated above is still way below the PNSDW.

#### 3.4.3. Power of Hydrogen

The pH is a measure of the total hydrogen ion species in the water sample. The water tested has a pH result of 7.7 in line with the acceptable value of 6.5-8.5. A slight increase of 0.7 was due to the dissolved ions which forms acidic or basic complexes as mentioned in the study by Hoff. Although present in minute quantities, these complexes could alter the overall hydrogen ion concentration and therefore affects the pH.

#### 3.4.4. Chloride

The mere presence of chlorides in the tested water could be attributed to the airborne chlorides found near coastal regions. The intrusion of chloride into the atmosphere is usually caused by wind-borne sprays of rain. The concentration of chloride in air decreases as increasing the distance from the shore. Under heavily industrialized areas, the amount of chloride ion in the atmosphere also increases due to coal burning. Thus, the presence of chlorine in Legazpi City is fairly because it is geographically a coastal city<sup>[9]</sup>.

#### 3.4.5. Color and Odor

The discoloration of the water could be attributed to different dissolved metal ions that are present in excess. Blue water can result if there is an overloading of copper or lead into the water, black or dark brown water if manganese ions are in excess, and reddish if iron ions are present excessively. Meanwhile, the odor coming from the water is traced from organic sources that are volatile<sup>[10]</sup>.

The result obtained a value of 1 TCU, an acceptable value below the limit of 5 TCU for its color evaluation. The ions dissolved were not in excess to cause discoloration of the water sample. In addition, the water sample has an unobjectionable odor, thus no traces of volatile organic pollutants, that may cause odor problems, were detected.

#### 3.4.6. Total Hardness

The abundance of carbonate rich rocks such as calcite on the surface could probably weather and be dissolved in water and be vaporized. It could also take form as mineral dust that may be constantly carried by the circulating air. It is therefore possible that carbonates may interact and mix with atmospheric water and be present in small amount in the water collected during experimentation<sup>[11]</sup>.

## 4. CONCLUSION

A working portable atmospheric water sequestrator (PAWS) was constructed and tested for its ability to condense atmospheric water vapor to clean water. The physico – chemical characteristics of the water generated could be classified as Public Water Supply Class I. The fabrication of such could be an alternative way to harness usable water easily and conveniently.

## Conflict of Interest

None.

## REFERENCES

1. Rose, J.B., *Water, sanitation and the millennium development goals: A report card on global progress. Water quality and health*, 2015: p. 1-2.
2. Simate, G.S., et al., *Human health effects of residual carbon nanotubes and traditional water treatment chemicals in drinking water. Environment international*, 2012. 39(1): p. 38-49.
3. Cabacungan, P.M., *CLEAN WATER SYSTEMS USING SOLAR POWER FOR OFF-GRID COMMUNITIES*. 2009, Ateneo de Manila University.
4. Nandy, A., et al., *A project on atmospheric water generator with the concept of peltier effect. International Journal of Advanced Computer Research*, 2014. 4(2): p. 481.
5. Kadhim, Z.K., M.S. Kassim, and A.Y.A. Hassan, *CFD study for cross flow heat exchanger with integral finned tube. International Journal of Scientific and Research Publications*, 2016. 6(6).
6. Begum, B.A., et al., *Identification of sources of fine and coarse particulate matter in Dhaka, Bangladesh. Aerosol and Air Quality Research*, 2010: p. 345-353.
7. Owen, M.K., D.S. Ensor, and L.E. Sparks, *Airborne particles sizes and sources found in indoor air. Atmospheric Environment*, 2003: p. 2149-2162.
8. Hoff, J.C., *The relationship of turbidity to disinfection of potable water, in Evaluation of the Microbiology Standards for Drinking Water*. 2000, US Environmental Protection Agency: Washington D.C. p. 103-110.
9. Sparks, D.L., *Advances in Agronomy*, ed. D.L. Sparks. Vol. 68. 1999: Academic Press.
10. *Color, taste, and odor problems in drinking water*. 2011, DOH
11. Emsley, J., *Nature's building blocks: an AZ guide to the elements*. 2011: Oxford University Press.



# **PROCESSOR MEANS FOR THE SPECTRAL ANALYSIS OF MEDICAL SIGNALS ON THE OF POLYNOMIAL WALSH BASES**

**Rakhimov Bakhtiyar Saidovich**

*Head of department Head of Department Biophysics and Information Technology  
Urgench branch of Tashkent Medical Academy*

**Allabeganov Odilbek Rakhimovich**

*Associate Professor Urgench branch of the Tashkent University of Information  
Technologies named after Al - Khwarizmi (Uzbekistan)*

**Saidov Atabek Bakhtiyayrovich**

*2nd year student Urgench branch of the Tashkent University of Information Technologies  
named after Al - Khwarizmi (Uzbekistan)*

## **ANNOTATION**

*The problem of increase of productivity of the computer is one of the central problems of development of computer aids. Search of decisions of this problem goes in a direction of development of principles of parallel and conveyor processing of the medical information, including, constructions of structures specialized processors.*

**KEY WORDS:** *information, specialized processor, signal, functions Walsh.*

## **1. INTRODUCTION**

The most perspective mathematical methods of increase of productivity of specialized processors of processing of signals concern such which would allow to use only linear arithmetic and logic operations. From this point of view most full satisfy the mathematical methods based on decomposition on systems of basic functions by Walsh. Presence of fast algorithms of calculation of spectral factors and realization of return transformations, sufficient convergence for technical appendices, possibility of reception of basic systems derivative of them by additional transformation, the prostate of an estimation of complexity of the scheme and its speed formed a basis for wide application of basis of Walsh in problems of digital processing of signals. The expediency of application of algorithms of fast transformations of Walsh is caused first of all by a technical reliability, wide enough class approximated specialized processors under the set external characteristics.

## **2. RELATED WORKS AND ITS PROBLEMS**

The signals are arriving from gauges of various devices in a type of data about a condition and measurement of temperature, radiating, and electromagnetic, gravitational, thermal and other physical fields often are multidimensional and difficult.

Problems of working out of algorithms for the express train of the analysis and the data processing, received with objects are actual, especially during ecological accidents. In the project these problems are solved.

Requirements of high efficiency of the computing systems applied in these areas can be satisfied as at the expense of development of new methods and algorithms of digital signal processing (DSP), and by means of multiprocessing means of in parallel-conveyor calculations [5,7]. The specialized computer [8] for performance of inverse Haar's transformation [1] of is known. The development purpose is device simplification. However, it possesses such lacks, as rather low speed, the limited



functionality. In [9] the device is developed for orthogonal transformation of digital signals on Haar's [3, 4] functions. Lacks are also rather low speed, low accuracy of transformation.

The major problems are finding-out of thin structure of signals, fast revealing of local features, forecasting of development of processes and time aspiration to use of the limited number of processors of processing. The transition of piecewise-quadratic Haar's and Harmut's [1, 2] functions and development of the computing structures, which are carrying out transformations on piecewise-quadratic functions, it allows to improve accuracy of approximation, to reduce quantity of the factors necessary for approximation, and by that to save a memory size [4, 5, 6]. The various applications principle is paralleling increase of speed of specialized computing structures [5, 7]. On the basis piecewise-polynomial methods models of computing means to develop for use in future internet based applications.

The computing means developed in this project work can be used in seismology, ecology for processing and restoration of signals, and also for the decision of problems of processing of results of vibrating tests.

### 3. OBJECTIVE STATEMENT

The main purpose of this project is to reduce the economic expenses of internet based applications using parallel-conveyor computing systems. To the limits of this project algorithm piecewise-polynomial signals processing from improvement positions of characteristics of computing means on their basis will be investigated, and also programs of their modeling and simulation will be developed for use in Internet based applications. The simulation and computing models is used program in MatLab and Simulink [3]. It offered set of models and means of signal processing on the basis of basic splines and fast spectral transformations is intended to use various applications[1, 2].

### 4. METHODOLOGY

The theoretical basis of the spent researches is made by the theory of the functional analysis, methods of splines-functions and modeling, variation and difference methods, methods of the numerical integration, the generalized spectral methods, the theory of numbers and matrixes, and also the theory of parallel computing processes.

### 5. REFERENCES

1. Carl de Boor. *A practical Guide to splines*. Department of computer science University of Wisconsin – Madison, Madison, USA, 2001.
2. Ren-Hong Wang. *Multivariate spline functions and their applications*. Kuliver Academic Press, Netherlands, 2001.
3. Rakhimov B.S., Ismoilov O.I., Ozodov R.O. Russian "Software and automation of forensic examination" *METHODS OF SCIENCE Scientific and practical journal №11 / 2017 pages 28-30*
4. Rakhimov B.S. Russian "Information technologies in medical education" *METHODS OF SCIENCE Scientific and practical journal №12 / 2017 pages 25-27*
5. R. Carranza, D. Andina. *Medical Wavelet-Neural Diagnostics in Chagastic Cardiopaties*. — Politechnical University of Madrid, 2000.
6. Uwe Meyer-Baese. *Digital signal processing with field programmable gate arrays*.-Florida state university, Florida, USA, 2007.
7. Susanto Rahardja, Bogdan J. Falkowski. *Application of Sign Haar Transform in a ternary communication system*. *International Journal of Electronics*, Volume 79, Issue 5 November 1995 , pages 551 - 559
8. U. Pen. *Application of Wavelets to Filtering of Noisy Data. In Wavelets: the Key to Intermittent Information?* — Oxford University Press, 2000.
9. Ashok, V. Balakumaran, T. Gowrishankar, C. Vennila, A. Kumar, A Nirmal. *The Fast Haar Wavelet Transform for Signal & Image Processing*. *International Journal of Computer Science and Information Security*, IJCSIS, USA(2010), January 2010, ISSN 1947 5500, <http://sites.google.com/site/ijcsis/>



## **TRADE UNION PRACTICES IN AN INDIAN BATTERY INDUSTRY: A STUDY**

**Panthula Sree Sai Pavan<sup>1</sup>**

<sup>1</sup> *Research Scholar, Dept. of Management, Dravidian University, Kuppam, A.P.*

**Prof.G.L.Narayanappa<sup>2</sup>**

<sup>1</sup> *Dean, School of Commerce and Management, Dravidian University, Kuppam, A.P.*

Article DOI: <https://doi.org/10.36713/epra4739>

### **STATEMENT OF THE PROBLEM**

ABC Batteries India Limited is one of the world class batteries manufacturing company established in the year 1985 and competing the global standards and competition in producing and marketing of batteries. It is the firm opinion of the 'ABC' Batteries Company that the standardization of quality of life by way of establishing the institution can extend evergreen accessibility to enhanced prospects and advantages to the mankind. By introducing the advanced engineering technology and scientific research, the 'ABC' Batteries Company has entered into MOUs with global companies and making partnership ventures with world class leaders for want of transfer and sharing of technology and proficiency.

After establishing the industry as a private one subsequently in the year 1990 the industry was converted as public limited industry. The ABC Batteries Company has entered into MOU with an international industry of USA on partnership basis with a partnership percentage of 22.

### **IMPORTANCE OF TRADE UNIONISM IN INDIAN BATTERY INDUSTRY**

In the recent times, there has been a regeneration of importance in the relationship between the employees and the unions. Hence, the swing to this drastic modernisations is that, the trade unions are playing vital role in central deliberations about the repercussions of contraption. Hence, the need of the hour is that the nature of relationship which the union should maintain with the management and the organization should implement

the same for the benefit of their employees/workers. Securing highest salaries/wages for the employees/workers and safeguarding of the job security and extent of protection for the employees/workers should be the vital aspects of motto of the trade unionism. Hence, it is stated that the trade unions should work for the increasing the productivity only when the hob-nob relations are prevailed between managements and the unions<sup>(1)</sup>.

The degree of unionism will play an enormous role in achieving its production targets. The battery industry has no exception for this. Hence, it is inevitable to seek the concern and co-operation of unions for achieving the production targets. The full pledged co-operation and efforts of the employees/workers can be expected only when the union maintains good relations with the management alone. Otherwise the organisations can not think of achieving production targets<sup>(2)</sup>.

It is obviously apparent that the concept of trade unionism is the vital parameter in the organisations to extract the maximum productivity from the employees. Recently, it is realized from the preceding decade that the sufficient strength of the union scientifically accomplishing the inclination of employees towards their job responsibility and eventually about the rate of employee turnover that would be reduced in the organisations to the most extent. Even though, the number of efforts offered by the organisations for the employees, certain interruptions have been observed during the course of productivity. In order to identify the specific reasons for the efforts of the union to wipe out such interruptions that this study has been taken up<sup>(3)</sup>.





It is realized that the various efforts extended by the unions will have immediate influence towards the productivity, psychological capability, physical health, foresight, attitude and all round adoptability of the employees for the circumstances for achieving larger productivity. Further the prime purpose of the trade unionism is to augment the lives and careers of employees to extend them happiness and encouragement.

Further, in the era of global competition in the market for battery products, the success of 'ABC' batteries company very much depends on the performance of union which is required for the organization to grab its share in the market towards the accomplishment of pre-determined goals. As per the philosophy of industrial relations the unions are the prime source which should be given at most priority to maximize the return on the capital to fulfill the business targets. The 'ABC' batteries company should put maximum efforts for the strengthening unions of their organisation and should extend all the facilities to the employees without single exception.

## REVIEW OF LITERATURE

Lawrence Egulu, (2004), in his study the author emphasized on the participation of trade union in the PRSP process. Through this research it is noticed that there is a huge emergency of upgrading the industrial skill sets and craftsmanship. Skills and training and development procedures will improve their standards, high quality, accessibility and relevance. It was noticed that the trade unions in MSMSE are much impacting on the economic growth and in generating of new employment opportunities. Creation of healthy atmosphere and harmonious relations depend upon the trade unions<sup>(4)</sup>.

NtwalaMwilima,(2008), the author underlined in this study that there is significant need of decent and sustainable jobs, which alleviate poverty. It is observed through this study that the trade union plays crucial role in job creation. Trade unions shows their impact on the macro-economic and social policies which plays, catalyst role in providing skill development training and job creation for main workers and extends development assistance. Trade unions involving and creating the direct and indirect jobs. In this study the author concluded that the trade unions play pivotal role in eradicating the unemployment in South Africa <sup>(5)</sup>.

Verena Schmidt, Maarten Keuneand Kevin Skerrett (ILO),(2009), have analysed the impact of the welfare practices in business environment and the consequences on the productivity of the organisation. Trade unions removed the hindrances of individual employee unions associations problems. Trade

unions have exhibiting the wide range of impact on the collective bargaining process. The collective bargaining plays utmost role in providing rules and measures for adequate earnings, judicial protection and social security. In the era of non-standard employment alliance, the rules and regulations designed by the parties involved in collective bargaining are not valid. Despite of that the pricing and allocation depends upon the market forces<sup>(6)</sup>.

PiyaliGhosh, ShefaliNandan, Ashish Gupta,(2009), In this research paper the authors stressed on the trade unions and stated that they involves actively in building sound working environment of NTPC as a part from maintaining viable industrial relations, Moreover, it is observed in this study that the welfare approach of the trade union is inspirable. It was evidenced in this study that membership in the trade unions are declining drastically over the period of time. Therefore, the researchers implicated that the active involvement of trade unions will attract more members into unions and increase welfare practices also to augment the union's membership<sup>(7)</sup>.

Josephine SeapeiMoeti-lysson, (2011), In this study the author emphasised on the concept that, whether the Botswana teaches union participated in labour relations or not. It implicates that there is a significant connection between the members and the trade unions. Botswana teaches union plays significant role in resolving the problems. Trade unionism as an ideology favours membership, since it strengthens the social recognition of the members and reduces the psychic of punishing non-members. Internal market affects the trade unions negatively due to control of unions, whereas unions stimulates the members to socialise their contacts among the members, which leads to less working hours and allows employees to meet during the leisure<sup>(8)</sup>.

Erik Bengtsson(2013), in this research paper the author empahsied on the income districpation between labour and capital market of Swdesh trade unions. It is underlined that the outsourcing agencies are using veto powers to invove in the trade unions. Author implicated the ambiguity of Swedish trade unions in usage of veto powers. It categorises that the consultation of union and the veto powers are two separate entities and the union upholds the diversity of labour market in developed economies<sup>(9)</sup>.

## SCOPE OF THE STUDY

The scope of this study is confined to the trade union practices of 'ABC' battery company only. The outcomes of this study cannot be comparable to any other similar industry or organisation.



## OBJECTIVES OF THE STUDY

The distinct objectives of the study are:

- i. To investigate the breathing of practices of trade union in ABC batteries industry;
- ii. To assess the level of satisfaction/dissatisfaction of employees/workers towards the breathing practices of trade union in 'ABC' Batteries Company;
- iii. To scrutinise the reasons for the dissatisfaction of employee/worker respondents towards the breathing practices of trade union in 'ABC' Batteries Company; and
- iv. To furnish the acceptable counter measures to flatten the dissatisfaction prevailed among the employees/workers towards the breathing practices of trade union in 'ABC' Batteries Company.

## RESEARCH METHODOLOGY

The methodology consists of data collection from primary as well as secondary sources. Through the survey method the first hand information was collected from 50 sample respondents from the study unit.

### Sample design and size

A purposive-cum-convenient sampling technique was followed and 50 respondents were chosen as sample respondents from the study unit.

## ANALYSIS OF THE DATA

The information collected from the respondents was processed and tabulated scientifically and several statistical tools like (i) Independent sample t-test; (ii) Weighted mean scores; (iii) 'ANOVA' are calculated at appropriate levels and the inferences were drawn.

### The Limitations

1. The study is confined to only one battery industry located in India;
2. The size of the sample is 50 only where the number is meagre.

## RESEARCH FINDINGS

1. The advancement of trade unionism from the implementation of employee welfare function towards a character forced by voice and delegation of employees appears to have taken freedom against the backdrop of the representation of employees/workers seems that there is a periodical and frequent interference of the unions which is resulting negatively (36.00%).

2. The high rate of enrolment of membership in unions with exorbitant contributions is not strengthening the bargaining power of unions and not at all deriving any successful outcomes. Further, the bargaining power of the unions is also unchanged (34.00%).
3. The unions are not able to properly collaborate with the management and also not able to command the managements for impersonal distribution of hierarchy (28.00%).
4. The present unions are putting their maximum efforts for enrolment more members into their unions to strengthen their members vote bank for achieving success in forthcoming union elections and to support certain political parties (26.00%).
5. The way of discharging the responsibilities of unions towards the implementation of employee welfare programmes is not admirable and significant. The union is discharging its responsibility only as an eye wash exercise and not at all concentrating on basic issues of employee welfare (22.00%).

## SUGGESTIONS

1. The multiplicity and mushroom birth of unions should be regulated. The union members must elect a leader for their unions such a person with high integrity, loyalty, moral values and ethics who will not be attracted to the temptations of the managements. Further, the proposed union leader must be a highly educated person who is having certain commitment towards the welfare of the fellow workers. So that the employee welfare programmes would automatically be implemented and such a honest and highly educated union leader will concentrate full time on solving the problems of individual workers.
2. For want of the implementation of the employee welfare programmes towards a character forced by the voice and delegation of employees, the unions should take the consensus of each and every individual employee. So that the freedom of the individual employees can be safeguarded and the reasonable attention can be paid to the representations of the employees with regard to the implementation of employee welfare programmes. Further, the periodical interface with the workers by the management should be resulted in effective implementation of the long pending benefits of the employees without giving any scope to negative impact.





3. Further, the enrolment rate of members into the unions should be minimized and the contributions to be collected from the members should also be enormously reduced. Collection of exorbitant contributions would result in landing the poor workers into debts with higher rates of interest.
4. The unions and union leaders should have cooperative attitude with the management towards positive things only which can enhance the welfare and wellbeing of both employees and employers too. Then only the unions would be able to command the managements for impersonal distribution of hierarchy.
5. The unions should play catalytic role between the employees/workers and the managements. Innumerable number of illiterate workers should not be enrolled as members in to the unions forcibly for want of their membership contributions. When, the workers are really interested in enrolling the unions, then only they should be admitted.
7. Piyali Ghosh, Shefali Nandan, Ashish Gupta, *the changing roles of trade unions in india: a case study of national thermal power corporation (ntpc), unchahar, Asian Academy of Management Journal, Vol. 14, No. 1, 37-57, January 2009*
8. Josephine Seapei Moeti-Lysson, *Effectiveness of trade unions in promoting employee relations in organisations. Department of Management, University of Botswana, Private Bag 0022, Gaborone .Botswana, Global J. Of Arts & Mgmt., 2011: 1 (4)*
9. Erik Bengtsson, *Essays on trade unions and functional income distribution, ISBN 978-91-86217-08-2 Published by the Unit for Economic History, Department of Economy and Society, School of Business, Economics and Law, University of Gothenburg Printed by Ineko, Göteborg 2013*

## REFERENCES

1. Josephine Seapel Moeti-Lysson: "Effectiveness of Trade Unions in promoting employee relations in organisation", *Research gate, Jan-2011, pp.56-57*
2. Purshothaman.G, Manjula purshothaman and Krishanmurthy.K: "A study on employee welfare measures in Neycer India Ltd", *Journal of Human Resource Management and Development, Vol.4, June 2014, p.23.*
3. Subhasish Chaterji, Medha Wadhva and Dhrashana Patel: "A study on employee welfare and its impact on their performance at private hospitals and its research centre-cross sectional descriptive study", *IJRAR, 2018, Vol.5, issue.12, p.504.*
4. Lawrence Egulu, 2004, *Trade Union Participation in the PRSP Process, Social Protection Unit Human Development Network The World Bank, No. 0417.*
5. Ntwala Mwilima, *The role of trade unions in job creation: a case study of the Job Creation Trust, The University of the Witwatersrand, December 2008.*
6. Verena Schmidt (ILO) Maarten Keune (University of Amsterdam) Kevin Skerrett (ILO), *Global capital strategies and trade union responses: Collective bargaining and transnational trade union cooperation, International Journal of Labour Research Geneva, International Labour Office, 2009 ISBN 978-92-2-122725-0 ISSN 2076-9806, Vol. 1 Issue 2.*



## LONG-TERM RESULTS OF TREATMENT OF PYELONEPHRITIS IN PREGNANT WOMEN

**Odilbek Razzaqberganovich Otajonov**

*Associate Professor Department of General Surgery, Traumatology and Orthopedics  
Urgench branch of Tashkent Medical Academy*

**Gulnora Odilbekovna Razzaqberganova**

*Department of General Surgery, Traumatology and Orthopedics  
Urgench branch of Tashkent Medical Academy*

### ANNOTATION

*The results of treatment with acute pyelonephritis of pregnant women in 67 patients were studied. The data obtained revealed high efficiency in providing highly skilled care to patients with acute pyelonephritis of pregnant women. This led to a significant reduction in the duration of treatment of patients, normal delivery and a significant improvement in the quality of life of patients.*

**KEY WORDS:** *acute pyelonephritis of pregnant women, stenting of ureter, percutaneous nephrostomy, delivery, quality of life of patients.*

### INTRODUCTION

The frequency of pyelonephritis is very high. According to A.Ya. Pytel and S.D. Goligorsky (1977), pyelonephritis is one of the most common human diseases, which takes second place after catarrh of the upper respiratory tract and is at the same time the most common form of kidney disease. According to O.L. Tiktinsky (1984), among urological patients with various diseases, secondary or concomitant pyelonephritis is determined in 89.3% of cases.

Due to the anatomical and physiological characteristics of the body, women suffer from pyelonephritis 5-6 times more often than men. According to N.A. Lopatkin and A.L. Shabad for 15 years of observation, the proportion of women among patients with pyelonephritis increased from 69 to 83%. The penetration of infection into the kidney mainly occurs ascending from the urethra and lower urinary tract. The short urethra in women and the proximity to the anus allow periurethral pathogenic bacteria to easily penetrate the lower urinary tract during sexual intercourse or urethral manipulations. In girls and women with a violation of local protection in the presence of infection on the eve of the vagina and vagina, periurethral colonization by

pathogenic flora and infection from the urethra often occur.

Men are less susceptible to ascending infection, since the secretion of the prostate gland contains zinc, which has a bactericidal effect.

In recent years, there have been reports on the phenomenon of bacterial adhesion to urothelial cells. *Escherichia coli* and *Proteus* have fimbriae, with the help of which they are fixed to urothelium and then move up the urinary tract. As A.V. Lyulko noted, the adhesive properties of bacteria are a prerequisite for the fixation, colonization and production of endotoxins, that is, for the induction of the inflammatory process in the kidneys and urinary tract. According to R. Maskell, the highest adhesion was observed in acute pyelonephritis, lower in acute cystitis and insignificant in asymptomatic bacteriuria, i.e. bacterial adhesion to a certain extent characterizes their virulence.

Clinical symptoms of acute pyelonephritis include: sudden onset of tremendous chills, high fever, constant pain in the lumbar region on one or both sides, dysuric effects, frequent urination, nocturia and pain during urination are sometimes observed. Of the common symptoms, malaise,



weakness, nausea, vomiting, headache, and others can be observed.

Modern technology has made it possible to abandon the traumatic methods of catheterization or stenting of the ureters in favor of alternative methods. It is advisable for the patient to perform percutaneous nephrostomy both for the purpose of derivation of urine and as the first stage of a subsequent endourological intervention through the formed fistulous course.

Inadequate drainage of the urinary tract or irrational antibiotic therapy can be a prerequisite for the development of purulent complications of pyelonephritis, fraught with possible urosepsis or bacterial shock. In these cases, patients are shown open surgery. As a rule, organ-preserving operations are performed.

Acute pyelonephritis of pregnant women is more common in later pregnancy, usually in the last trimester, but can occur in the first and second trimester. The development of acute pyelonephritis in pregnant women in the first and second trimester is usually associated with hormonal changes in the female body after pregnancy, and in the third trimester it is usually associated with mechanical compression of the ureter.

One in ten pregnant women has a urinary tract infection (UTI). Acute pyelonephritis develops in 20–40% of pregnant women with a urinary tract infection, and relapses of acute pyelonephritis in 10–30% of pregnant women. A study by Kass and his co-authors showed that 20–40% of women with asymptomatic bacteriuria develop pyelonephritis during pregnancy. Treating bacteriuria reduces the risk of developing pyelonephritis. In acute pyelonephritis of pregnant women, there are always violations of urodynamics and the possibility of toxic effects of drugs on the fetus.

Treatment of pregnant pyelonephritis: second and third generation cephalosporins, aminopenicillin with  $\beta$  lactamase inhibitors or aminoglycosides.

Fluoroquinolones, tetracyclines and TMP (trimethoprim) in the first trimester and sulfonamides in the last trimester are contraindicated.

A slow decrease in temperature and an expansion of the upper urinary tract may be an indication for stenting the ureter, and antibiotic prophylaxis should be considered before delivery and in the postpartum period.

## **MATERIALS AND METHODS**

From 2011 to 2016, 67 pregnant women with gestational pyelonephritis from the age of 19 to 34 were under our supervision in the Khorezm branch of the RSSC (Republican Specialized Center of Urology). Their gestational age was from 12 to 35

weeks. They complained of pain in the lumbar region, an increase in body temperature from 38 to 39–40 ° C with chills, nausea, lack of appetite, and general weakness. The duration of these symptoms varied from 3 to 5 days. All pregnant women underwent a comprehensive laboratory and instrumental examination aimed at elucidating the functional state of the upper urinary tract and the activity of the inflammatory process in the kidneys, with the collection of urine from the middle portion for bacteriological culture. When examined by a gynecologist, none of the patients showed a threat of miscarriage. Statistical processing of the data obtained by the method of student and Fisher.

## **RESULTS AND ITS DISCUSSION**

All pregnant women were divided into 2 groups. The 1st group included 41 patients whose ultrasound (ultrasound) of the kidney revealed a pelvic expansion of 2.5 to 3.5 cm, calyx expansion of 0.5 to 1.5 cm. In these pregnant women, urodynamic disturbances of urine outflow from upper urinary tract, which required the restoration of impaired passage of urine by performing internal drainage of the stent and the simultaneous use of etiotropic therapy to eliminate the progression of pyelonephritis. Two pregnant women received percutaneous nephrostomy in the upper third due to knee-shaped deviation of the ureter. Combination therapy was prescribed to patients of this group: antibiotic (ceftazidime) 1.0 x 3 times a day, intramuscularly and canefron 1 tab x 3 times a day, as well as infusion and detoxification therapy.

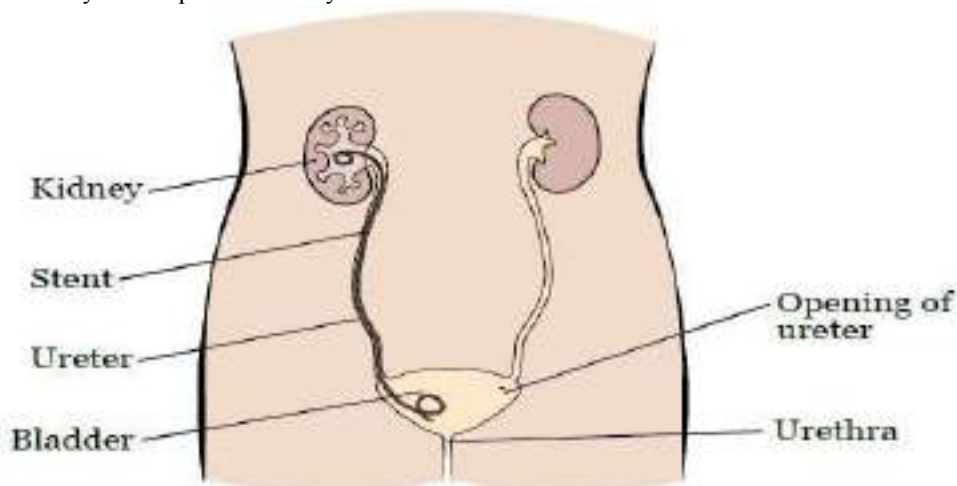
The 2nd group consisted of 26 patients in whom an ultrasound of the kidney revealed a slight expansion of the pyelocaliceal system and showed no signs of obstruction of the upper urinary tract. One patient in this group showed an increase in intoxication, a deterioration in general condition during pregnancy progression without the threat of miscarriage. She did not show a deterioration in the concentration ability of the kidneys and an increase in the level of creatinine and urea in the blood, but in the general analysis of blood there was a high leukocytosis with a shift to the left. This patient was diagnosed with acute apostematic pyelonephritis and had surgery with revision and decapsulation of the kidney and drainage of the kidney. In the postoperative period, she was also prescribed ceftazidime 1.0 x 3 times a day, intramuscularly and canefron 1 tab x 3 times a day, as well as infusion and detoxification therapy.

In 80 patients of both groups, in bacteriological cultures of urine, *E. coli* 10x4-10x5 CFU / ml sensitive to ceftazidime, cefotaxime, and cefoperazone was isolated in 80.6% of cases. *Proteus* was found in 5% of cases, and *Klebsiella* in 5%,

Staphylococcus in 5.4%, and microflora was not found in the remaining 4%. In the 1st patient with a gestational age of 30 weeks (2nd group), chlamydia trachomatis was found.

In group 1, 39 patients under intravenous anesthesia performed stenting of the upper urinary tract, and nephrostomy in 2 patients. They were

prescribed antibiotics based on sensitivity. In group 2, 26 patients were also prescribed etiotropic therapy according to the antibiotic profile, and one of them was supplemented with vilprofen (daily dose of 1000 mg) taking into account the detected chlamydia trachomatis.



**Fig. 1. Uterine stenting.**



**Fig 2. Percutaneous nephrostomy.**

We used intensive antibacterial, infusion, detoxification therapy for patients of both groups, as well as knee-elbow therapy.

Evaluation of the effectiveness of treatment was carried out in dynamics by changing ultrasound, reducing clinical symptoms, restoring the passage of urine, urinalysis and the observation of a gynecologist. Adverse events and drug tolerance were evaluated by laboratory and subjective data.

After treatment, a positive clinical effect was noted in patients of both groups, but especially in group 1, who underwent stenting of the ureter and PC nephrostomy (2 patients) to eliminate impaired passage of urine from the upper urinary tract. Their

clinical symptoms of the disease 2 times reliably faster disappeared, their bed was reduced, their general condition improved compared with patients of group 2, where these indicators disappeared somewhat more slowly. In 3 patients of the 1st group, a stent was removed before childbirth; the rest had stent removal and nephrostoma 3-4 weeks after the birth.

In 37 women in labor (90%) of the 1st group, there were deliveries on time, without complications, and in the 2nd group, half of the patients had premature births with a low fetal weight.

Thus, in the treatment of acute pyelonephritis of pregnant women, it is necessary to



carefully collect anamnesis from patients, timely hospitalize them for an adequate diagnosis and highly qualified adequate treatment, and, if the condition worsens, signs of urinary tract obstruction, perform stenting and / or PC nephrostomy before delivery with ultrasound monitoring of the kidneys, pelvic organs, a joint examination of a urologist and gynecologist. This will improve delivery results in patients with acute pyelonephritis in pregnant women.

Patients were followed up for 3 years. Every 6 months, an ultrasound scan of the kidneys was performed, urine analysis according to Nechiporenko. Only 3 patients (from the 1st group who removed the stent before delivery) and 5 patients (who removed the nephrostomy before delivery) in the postpartum period (from 3 to 6 months) were re-infected. These patients were treated in-patiently until recovery.

## CONCLUSION

In pregnant women, stent and / or nephrostomy should be removed after delivery. This approach will improve the quality of life of patients and prevent reinfection.

## LITERATURE

1. "Urology", ed. Acad. N.A. Lopatkina. M.: 2002
2. Urology by Donald Smith. Ed. E. Tanago and J. Makanich. Translation from English "Practice" Moscow: 2005
3. "Handbook of a general practitioner" J. Murt. M.: "Practice", 1998.
4. Actual issues of urology and andrology. St. Petersburg, 2011
5. Guidelines of European Association of Urology, 2010.
6. Guide to Urology in 3 volumes, ed. Acad. N.A. Lopatkina. M.: 1998





# MODELING AND PROJECTION OF NEW HIV INFECTIONS IN CHILDREN AGED BETWEEN 0 AND 14 YEARS IN ZIMBABWE USING BOX-JENKINS ARIMA MODELS

**Dr. Smartson. P. NYONI**

*ZICHIRE Project, University of Zimbabwe, Harare, Zimbabwe*

**Mr. Thabani NYONI**

*Department of Economics, University of Zimbabwe, Harare, Zimbabwe*

## ABSTRACT

*This paper uses annual time series data on new HIV infections in children aged between 0 – 14 in Zimbabwe from 1990 – 2018; to forecast new HIV infections over the period 2019 – 2023. The study applies the generalized Box-Jenkins ARIMA technique. Diagnostic tests show that C is an I (2) series. Model evaluation criteria indicate that the optimal model is the ARIMA (1, 2, 0) model. The study concludes that it is possible to have an AIDS-free generation in Zimbabwe as hinted by a projected sharp downwards trend of new HIV infections in the out-of-sample period. The study offers a 4-fold policy prescription in order to prevent and control new HIV infections in children in the country.*

## 1.0 INTRODUCTION

The HIV/AIDS epidemic has become a serious health and development problem (Takarinda *et al.*, 2016) in many countries around the world and is a major contributing factor to childhood disease and mortality (UNAIDS, 2002). HIV (Human Immunodeficiency Virus) is the virus that causes AIDS (Acquired Immune Deficiency Syndrome). HIV destroys the biological ability of the human body to fight off opportunistic infections. A person can be infected with HIV for a long time without showing any symptoms of the disease. Nonetheless, during that period before a person develops symptoms, he or she can transmit the infection through sexual contact to other, uninfected people. An infected woman can also transmit the disease to her unborn child or breast-feeding infant. AIDS itself is defined in terms of how much deterioration of the immune system has taken place as seen by the presence of opportunistic infections (Ministry of Health & Child Welfare, 1998).

The first AIDS case was reported in Zimbabwe in 1985 (Mapenzauswa, 2004). Since then more patients began to present with illnesses suggestive of HIV infection. Young adults presented with severe respiratory infections, herpes zoster, persistent generalized lymphadenopathy and diarrhea associated with weight loss (Topley, 1988; Dehne *et al.*, 1992). Children were seen who seemed to be suffering from malnutrition but whose socio-economic backgrounds were inconsistent with poverty (Ikeogu *et al.*, 1997; Ticklay *et al.*, 1997). Unfortunately such patients failed to respond to standard nutritional and conventional medical treatments, suggesting an immunodeficiency condition (Duri *et al.*, 2013).

Children may acquire HIV infection during pregnancy, labour, delivery or after birth during breast feeding. Fortunately, most children born to HIV infected mothers are not infected. Estimates of the rates of mother-to-child transmission (MTCT) of HIV have ranged (without the use of antiretroviral (ARV) drugs





during pregnancy and in the newborn) from 15-25% in industrialized countries to 25-35% in developing countries. Among infected infants who are not breast-fed, about two-thirds of cases of MTCT occur around the time of delivery and the rest during pregnancy (mostly during the last two months). In societies where breast feeding is the norm, it accounts for about one-third of all transmissions. As a result, the proportion of infants infected through MTCT is higher in these societies than those where mothers with HIV infection can safely avoid breastfeeding. MTCT of HIV is a huge problem in Zimbabwe which has become the major cause of infant and child mortality (Mahomva, 2007). It is the most significant (90%) source of HIV infection in children below the age of 15 years (Duri *et al.*, 2013). HIV infection can also be transmitted through blood transfusion and the use of contaminated needles and syringes, especially in emergency situations. Child sexual abuse is another significant cause of childhood HIV infection, especially in developing countries where discussions about child sexual abuse is still a taboo. It is important to know that, with good care and support, infected children can live a longer and better life (UNAIDS, 2002).

Worthy to note is the fact that in Zimbabwe, all HIV positive patients are commenced on ART (antiretroviral therapy) regardless of WHO clinical staging. The ARV drugs dosages depend on age and weight of the patient. However, all HIV positive patients should be screened for TB before ART initiation, in line with government policy on HIV/TB program collaboration. In Zimbabwe, early detection and diagnosis of HIV in infants is done using DNA-PCR testing. Early ART initiation for HIV positive infants is critical to reduce morbidity and mortality in this age group. This study, whose 3-fold objectives are outlined below, will model and project new HIV infections in children aged between 0 and 14 years in Zimbabwe using ARIMA models. Literature is plenary with HIV related studies in Zimbabwe, for example, Topley (1988); Ikeogu *et al.* (1997); Ticklay *et al.* (1997); Mahomva (2007); Dube *et al.* (2008); Duri *et al.* (2013); Takarinda *et al.* (2016) and Nyoni & Nyoni (2020). With the exception of Nyoni & Nyoni (2020), so far, no Zimbabwean study has projected new HIV infections. This paper will be the second empirical paper in the country to project new HIV infections but will be different from Nyoni & Nyoni (2020) in the sense that the current endeavor focuses on analyzing new HIV infections in children aged between 0 and 14 yearly only. There is no doubt; this paper is the first

country-specific study to investigate pediatric HIV in Zimbabwe from a time series forecasting perspective.

## 1.2 OBJECTIVES OF THE STUDY

- i. To investigate the years during which new HIV infections in children peaked in Zimbabwe.
- ii. To forecast the number of new HIV infections in children for the out-of sample period.
- iii. To examine the pattern of new HIV infections in children for the out-of-sample period.

## 1.3 RELEVANCE OF THE STUDY

Globally, about 2.7 million children are currently living with HIV infection. In fact, more than 1500 children become infected with HIV every day. The vast majority (more than 90%) acquire the infection from their mother (UNAIDS, 2002). Eastern and Southern Africa is home to more than 60% of children and adolescents living with HIV (UNICEF, 2018). Zimbabwe has an estimated 1.3 million people living with HIV (Global AIDS Response Report, 2018) and is one of the Southern Sub-Saharan African countries that has been hardest hit by the pandemic (Ministry of Health and Child Care, 2014). Between 1980 and 2005, among 10 million children born in Zimbabwe, a cumulative 504000 were vertically infected with HIV (Dube *et al.*, 2008). As of 2010, it is estimated that approximately 120000 children between the ages of 0 – 14 are living with HIV/AIDS of which 3.4% of children aged 10 years are long-term survivors following MTCT (Ferrand *et al.*, 2009). As of 2018, only 4800 children between the ages of 0 – 14 are living with HIV/AIDS as shown in figure 1 below. Indeed, the numbers have declined. This study, whose objectives are stated above, will go a long way in helping policy makers in the country in terms of providing information on designing appropriate controlling and preventive measures in order to bring a long term solution.

## 2.0 LITERATURE REVIEW

In Asia, Yu *et al.* (2013) employed the ARIMA model to forecast the number of new HIV infections in the Korean population using a data set covering the period 1985 to 2012. The results of the study basically indicate that the ARIMA (2, 2, 1) model is the optimal model. Using an annual data set covering the period 1990 to 2013, Demissew (2015); evaluated ARIMA models in order to establish the trend and project HIV/AIDS epidemics in Ethiopia. The ARIMA (2, 3, 2) model appeared to be providing the best fit for the



observed data set. The prediction showed that the prevalence of HIV/AIDS would decrease in Ethiopia for the next 5 years. In Uganda, Rubaihayo *et al.* (2016) relied upon monthly observational data collected over a 10-year period (2004-2013) by The AIDS Support Organization (TASO) to forecast 5-years annual prevalence of any OI covering the period 2014 – 2018. The OIs considered include 14 AIDS-defining OIs, 2 non-AIDS defining OIs (malaria & geohelminths) and HIV associated Kaposi’s sarcoma. The Box-Jenkins methodology was used. The results indicate that the ARIMA (1, 1, 1) model was the most parsimonious model and best fit model for the data.

In Nigeria, Abu & Emeje (2019); using an annual data set covering the period 1991-2015, examined ARIMA models in order to establish the prevalence of HIV. Model performance tests based on the MAE and the MSE showed that the ARIMA (7, 1, 0) model was the optimal model. The forecast results showed that there would be 1.5%, 0.97% and 0.71% prevalence in 2016, 2017 and 2018, respectively. In a Zimbabwean study, Nyoni & Nyoni (2020) used monthly time series data on new HIV infections at

Silobela District Hospital (SDH) from January 2014 to December 2018; to predict new HIV infections based on the Box-Jenkins technique. The study actually presented the SARIMA (0, 1, 1)(0, 1, 1)<sub>12</sub> model, which indicated that new HIV infections in the community of Silobela will decline over the out-of-sample period.

### 3.0 MATERIALS & METHODS

#### ARIMA Models

The Box-Jenkins ARIMA model continues to be used in modeling and forecasting new HIV infections (Yu *et al.*, 2013, Demissew, 2015; Rubaihayo *et al.*, 2016; Abu & Emeje, 2019; Nyoni & Nyoni, 2020). ARIMA models are used for observable non-stationary processes that have some clearly identifiable trends (Kuhe *et al.*, 2016). This study will employ the ARIMA models in order to analyze annual new HIV infections in children in Zimbabwe. ARIMA models are accredited to Box & Jenkins (1970), hence the term “Box-Jenkins ARIMA models”. The general ARIMA (p, d, q) model can be represented by a backward shift operator as follows:

$$\Phi(B)(1 - B)^d C_t = \theta(B)\mu_t \dots \dots \dots [1]$$

Where the autoregressive (AR) and moving average (MA) characteristic operators are:

$$\Phi(B) = (1 - \phi_1 B - \phi_2 B^2 - \dots - \phi_p B^p) \dots \dots \dots [2]$$

$$\theta(B) = (1 - \theta_1 B - \theta_2 B^2 - \dots - \theta_q B^q) \dots \dots \dots [3]$$

and

$$(1 - B)^d C_t = \Delta^d C_t \dots \dots \dots [4]$$

Where  $\Phi$  is the parameter estimate of the autoregressive component,  $\theta$  is the parameter estimate of the moving average component,  $\Delta$  is the difference operator, d is the difference, B is the backshift operator and  $\mu_t$  is the disturbance term.

#### The Box – Jenkins Methodology

The first step towards model selection is to difference the series in order to achieve stationarity. Once this process is over, the researcher will then examine the correlogram in order to decide on the appropriate orders of the AR and MA components. It is important to highlight the fact that this procedure (of choosing the AR and MA components) is biased towards the use of personal judgement because there are no clear – cut rules on how to decide on the

appropriate AR and MA components. Therefore, experience plays a pivotal role in this regard. The next step is the estimation of the tentative model, after which diagnostic testing shall follow. Diagnostic checking is usually done by generating the set of residuals and testing whether they satisfy the characteristics of a white noise process. If not, there would be need for model re – specification and repetition of the same process; this time from the second stage. The process may go on and on until an appropriate model is identified (Nyoni, 2018c).

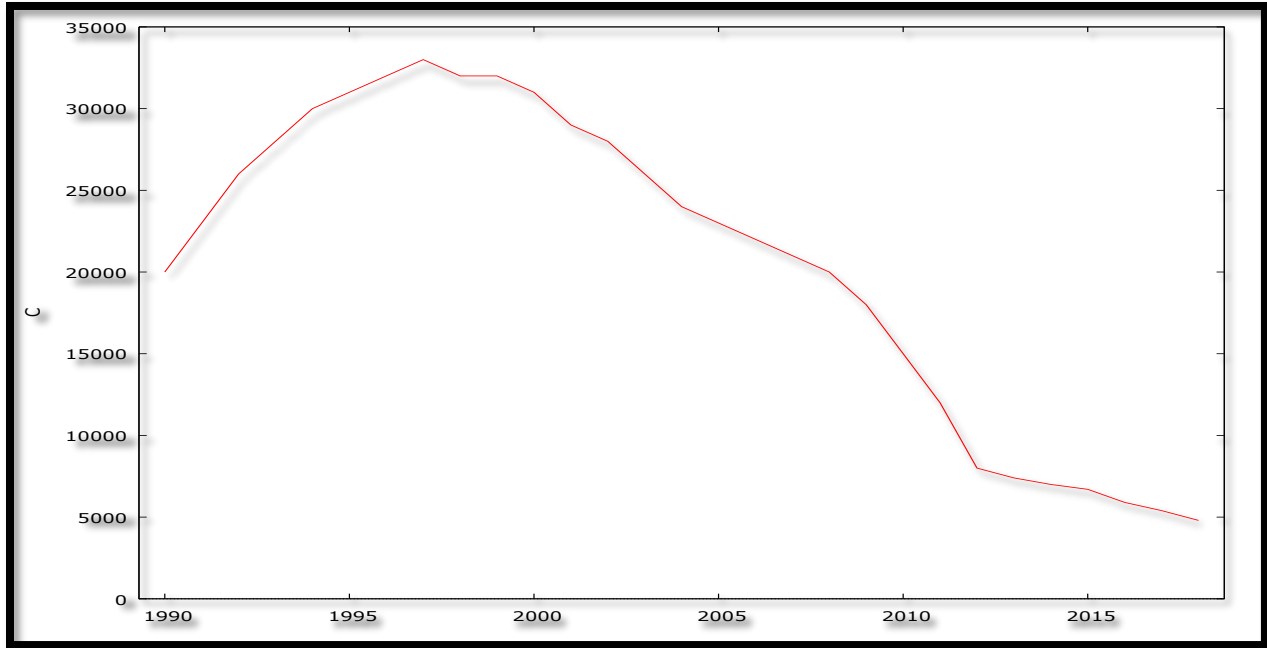
#### Data Collection

This study is based on 29 observations of annual total new HIV infections in children aged between 0 and 14 years (C) in Zimbabwe. All the data was gathered from the World Bank online database.



**Diagnostic Tests & Model Evaluation  
Stationarity Tests: Graphical Analysis**

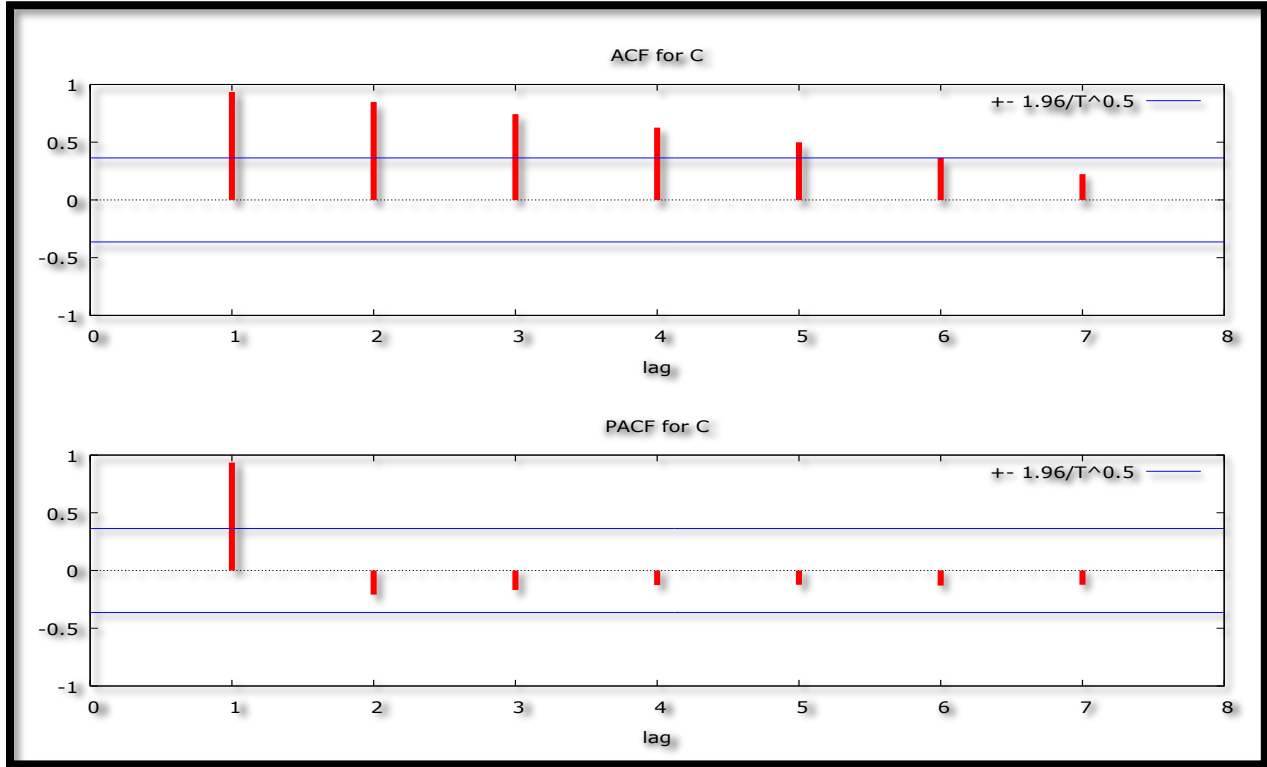
**Figure 1**





**The Correlogram in Levels**

**Figure 2**



**The Augmented-Dickey-Fuller (ADF) Test**

**Table 1: Levels-intercept**

Variable	ADF Statistic	Probability	Critical Values	Conclusion
C	-0.755823	0.8155	-3.699871 @1%	Not stationary
			-2.976263 @5%	Not stationary
			-2.627240 @10%	Not stationary

**Table 2: Levels-trend & intercept**

Variable	ADF Statistic	Probability	Critical Values	Conclusion
C	-3.040789	0.1402	-4.339330 @1%	Not stationary
			-3.587527 @5%	Not stationary
			-3.229230 @10%	Not stationary

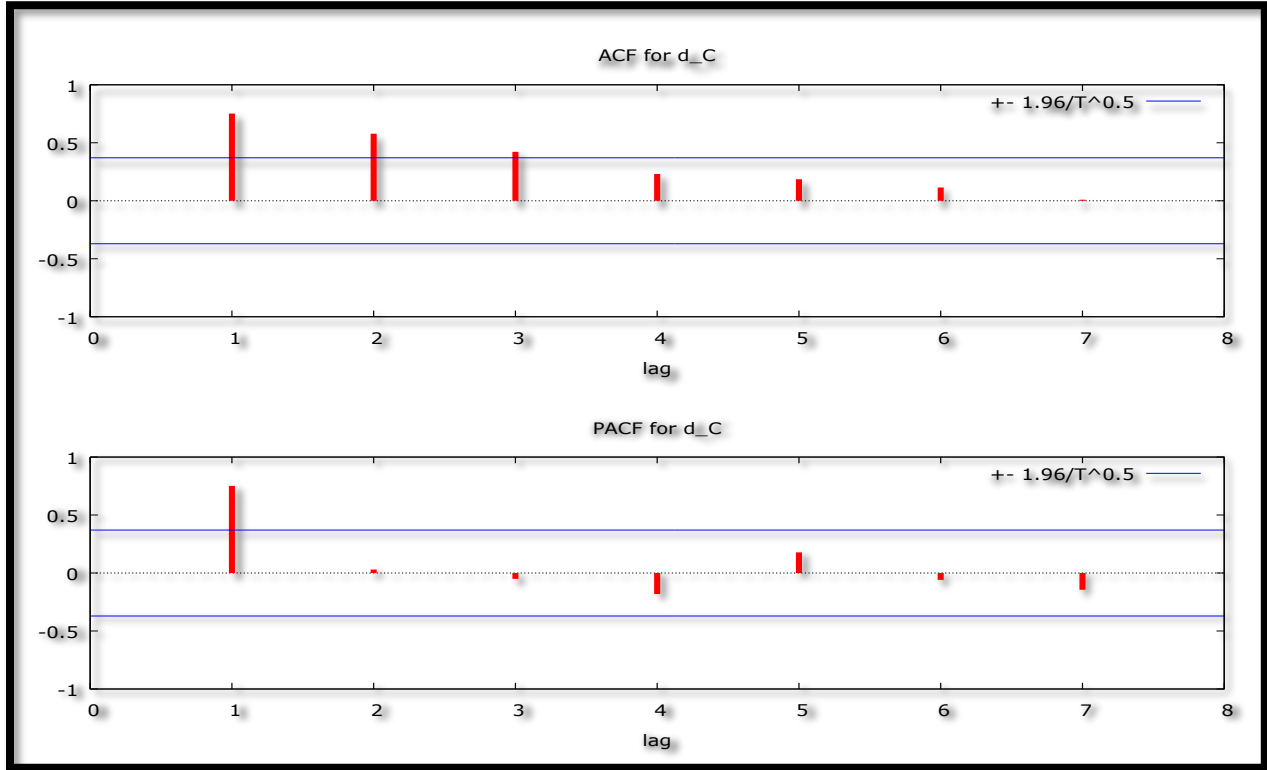
**Table 3: without intercept and trend & intercept**

Variable	ADF Statistic	Probability	Critical Values	Conclusion
C	-1.626061	0.0969	-2.653401 @1%	Not stationary
			-1.953858 @5%	Not stationary
			-1.609571 @10%	Stationary



**The Correlogram (at 1<sup>st</sup> Differences)**

**Figure 3**



**Table 4: 1<sup>st</sup> Difference-intercept**

Variable	ADF Statistic	Probability	Critical Values		Conclusion
D(C)	-2.382047	0.1559	-3.699871	@1%	Not stationary
			-2.976263	@5%	Not stationary
			-2.627420	@10%	Not stationary

**Table 5: 1<sup>st</sup> Difference-trend & intercept**

Variable	ADF Statistic	Probability	Critical Values		Conclusion
D(C)	-2.000219	0.5750	-4.339330	@1%	Not stationary
			-3.587527	@5%	Not stationary
			-3.229230	@10%	Not stationary

**Table 6: 1<sup>st</sup> Difference-without intercept and trend & intercept**

Variable	ADF Statistic	Probability	Critical Values		Conclusion
D(C)	-2.008454	0.0445	-2.653401	@1%	Not stationary
			-1.953858	@5%	Stationary
			-1.609571	@10%	Stationary

Figure 1 shows the trend of C over the period 1990 – 2018. New HIV infections in children aged between 0 and 14 were on the rise between 1990 and 1997. This could be attributed to the fact that the pandemic was not yet well known and properly prevented in developing countries such as Zimbabwe. Since the onset of the new millennium in 2000, new HIV infections in children have followed a downwards

trajectory. This could be attributed to the government response to the pandemic, especially through implementing various preventive measures. Figures above, that is; 2 and 3 and tables above, that is; 1 to 6 also show that C is not stationary in levels and even after taking first differences.



The Correlogram in (2<sup>nd</sup> Differences)

Figure 4

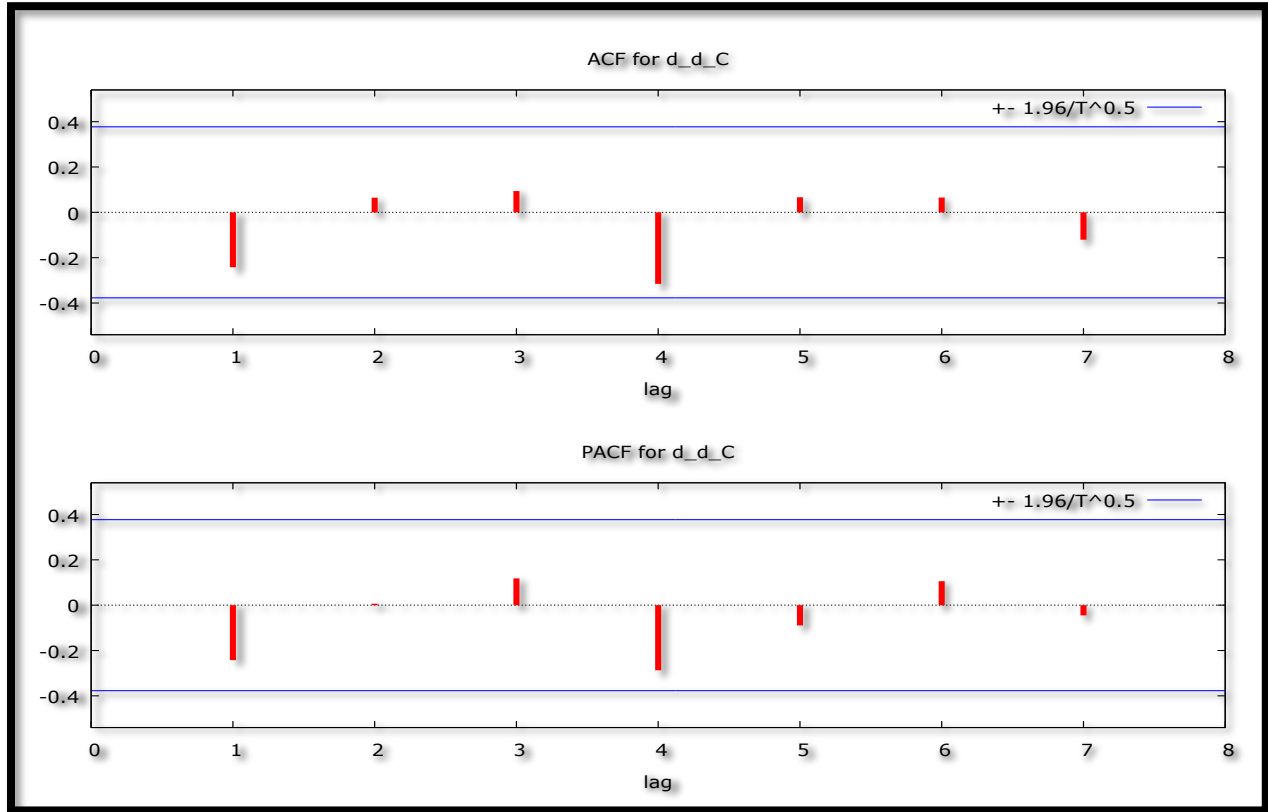


Table 7: 2<sup>nd</sup> Difference-intercept

Variable	ADF Statistic	Probability	Critical Values		Conclusion
D(D(C))	-6.274801	0.0000	-3.711457	@1%	Stationary
			-2.981038	@5%	Stationary
			-2.629906	@10%	Stationary

Table 8: 2<sup>nd</sup> Difference-trend & intercept

Variable	ADF Statistic	Probability	Critical Values		Conclusion
D(D(C))	-6.745379	0.0000	-4.356068	@1%	Stationary
			-3.595026	@5%	Stationary
			-3.233456	@10%	Stationary

Table 9: 2<sup>nd</sup> Difference-without intercept and trend & intercept

Variable	ADF Statistic	Probability	Critical Values		Conclusion
D(D(C))	-6.252229	0.0000	-2.656915	@1%	Stationary
			-1.954414	@5%	Stationary
			-1.609329	@10%	Stationary

Figure 4 and tables 7 – 9 illustrate that the series under consideration is I (2).





**Evaluation of ARIMA models (without a constant)**

**Table 10: Evaluation of ARIMA Models**

Model	AIC	U	ME	MAE	RMSE	MAPE
ARIMA (1, 2, 1)	454.2985	0.87067	-158.86	679.42	974.6	4.9218
ARIMA (1, 2, 0)	<b>452.3098</b>	0.87084	-160.84	680.93	974.81	4.9524
ARIMA (0, 2, 1)	452.4601	0.86897	-163.77	687.39	977.73	5.0038
ARIMA (2, 2, 1)	456.2503	0.87576	-151.17	674.91	973.7	4.87
ARIMA (3, 2, 1)	457.1566	0.93523	-137.99	667.9	952.87	5.3766
ARIMA (1, 2, 3)	457.5227	0.93377	-124.68	661.76	959.82	5.1923
ARIMA (0, 2, 3)	455.9345	0.88688	-142.48	695.94	966.96	5.2782
ARIMA (3, 2, 0)	455.8078	0.92018	-136.24	666.12	965.21	5.0724
ARIMA (2, 2, 0)	454.2829	0.87127	-155.55	676.74	974.31	4.8777
ARIMA (0, 2, 2)	454.0088	0.89918	-133.49	683.1	968.93	5.1521

A model with a lower AIC value is better than the one with a higher AIC value (Nyoni, 2018b). Similarly, the U statistic can be used to find a better model in the sense that it must lie between 0 and 1, of

which the closer it is to 0, the better the forecast method (Nyoni, 2018a). In this paper, only the AIC is used to select the parsimonious model. Therefore, the ARIMA (1, 2, 0) model is chosen.

**Residual & Stability Tests**

**ADF Tests of the Residuals of the ARIMA (1, 2, 0) Model**

**Table 11: Levels-intercept**

Variable	ADF Statistic	Probability	Critical Values		Conclusion
R	-4.944338	0.0005	-3.724070	@1%	Stationary
			-2.986225	@5%	Stationary
			-2.632604	@10%	Stationary

**Table 12: Levels-trend & intercept**

Variable	ADF Statistic	Probability	Critical Values		Conclusion
R	-5.295612	0.0013	-4.374307	@1%	Stationary
			-3.603202	@5%	Stationary
			-3.238054	@10%	Stationary

**Table 13: without intercept and trend & intercept**

Variable	ADF Statistic	Probability	Critical Values		Conclusion
R	-4.962135	0.0000	-2.660720	@1%	Stationary
			-1.955020	@5%	Stationary
			-1.609070	@10%	Stationary

Tables 11 – 13 indicate that the residuals of the chosen optimal model, the ARIMA (1, 2, 0) model; are stationary. This indicates that the applied model is stable. This has also been confirmed in figure 6 below.

Hence the selected optimal model is suitable for forecasting new HIV infections in children aged between 0 and 14 in Zimbabwe.



**Correlogram of the Residuals of the ARIMA (1, 2, 0) Model**

**Figure 5: Correlogram of the Residuals**

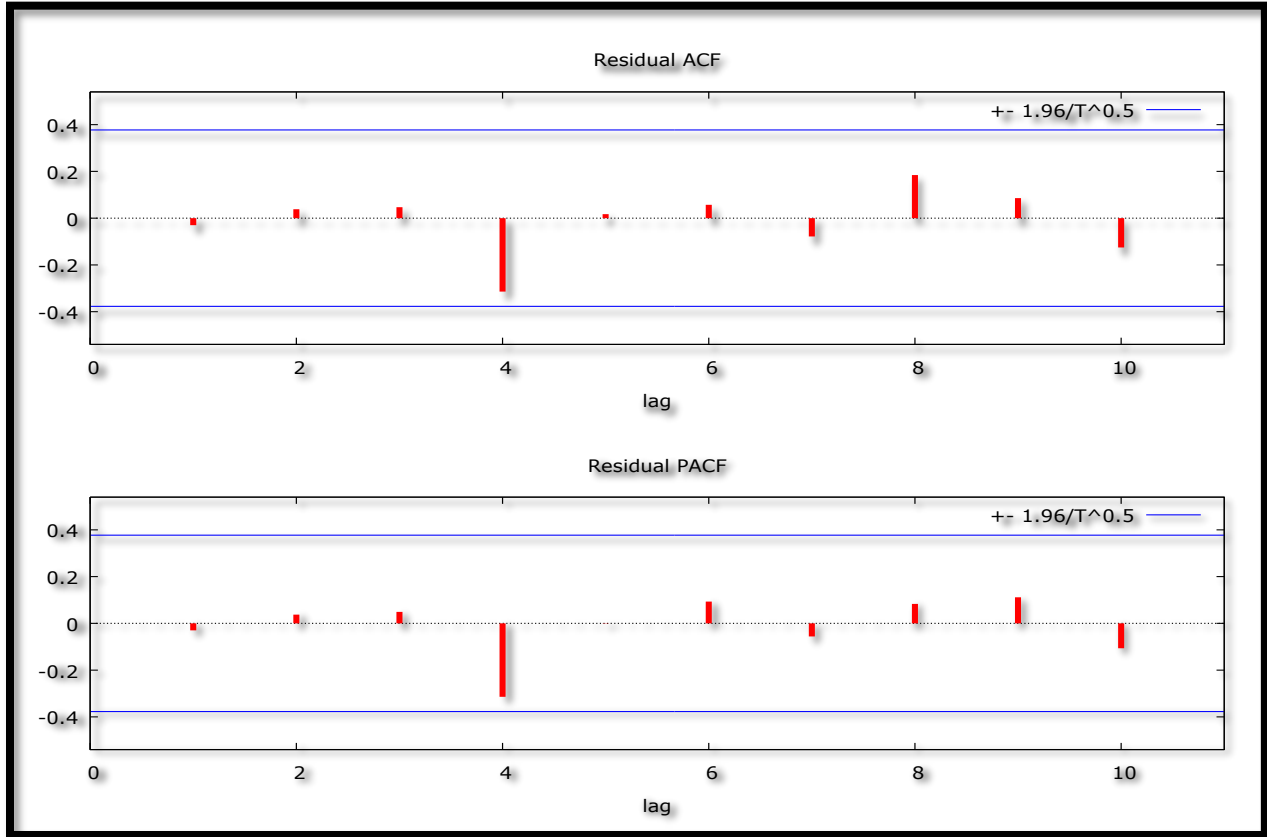
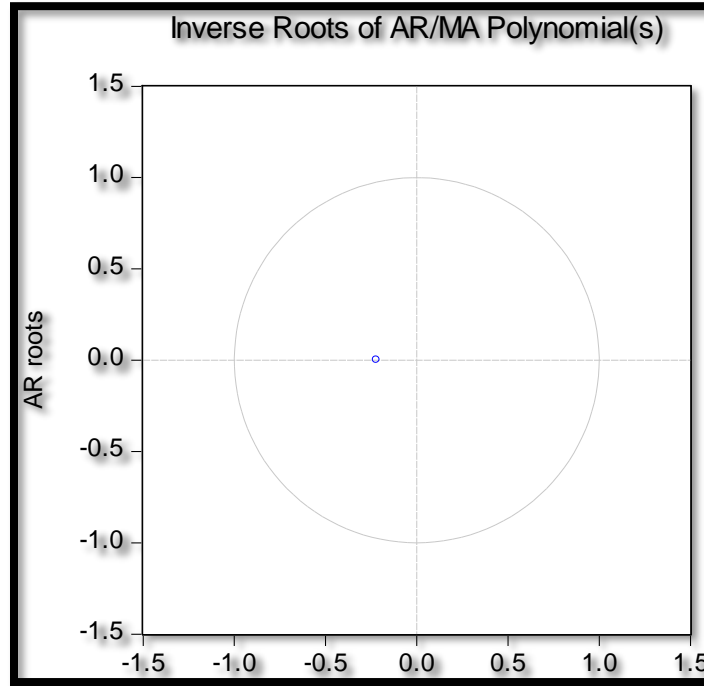


Figure 5 indicates that the estimated ARIMA (1, 2, 0) model is adequate since ACF and PACF lags are quite short and within the bands. This implies that the assumption of no autocorrelation is valid in this study.



**Stability Test of the ARIMA (1, 2, 0) Model**

**Figure 6: Inverse Roots**



Since all the AR roots lie inside the unit circle, it means that the estimated ARIMA process is (covariance) stationary; thus confirming that the ARIMA (1, 2, 0) model is quite stable and suitable for forecasting new

HIV infections in children (0-14 years old) in Zimbabwe.

**4.0 FINDINGS**

**Descriptive Statistics**

**Table 14: Descriptive Statistics**

Description	Statistic
Mean	20731
Median	23000
Minimum	4800
Maximum	33000
Standard deviation	9695.7
Skewness	-0.42985
Excess kurtosis	-1.2429

As shown above, the mean is positive, i.e. 20731. This means that the average number of new HIV infections over the study period is 20731 infections per annum. The minimum number of new HIV infections over the study period is 4800 infections and this was recorded in 2018 while the maximum

number of infections is 33000 and this was recorded in 1997. The skewness is -0.42985 and the most essential characteristic is that it is negative, meaning that C is negatively skewed and non-symmetric. Excess kurtosis is -1.2429; showing that C series is not normally distributed.



**Results Presentation**

**Table 15: Main Results**

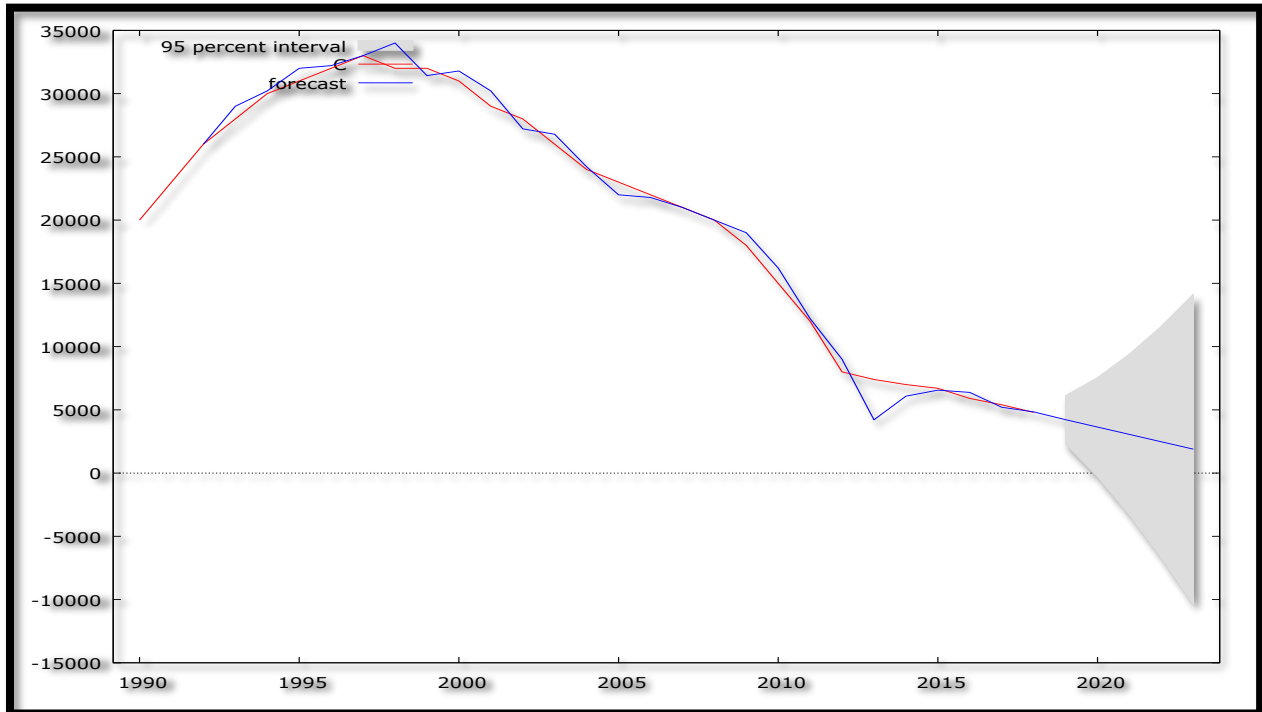
**ARIMA (1, 2, 0) Model:**

$$\Delta^2 C_{t-1} = 1.3784\Delta^2 C_{t-1} \dots \dots \dots [5]$$

Variable	Coefficient	Standard Error	z	p-value
$\phi_1$	-0.212202	0.187776	-1.130	0.2584

**Forecast Graph**

**Figure 7: Forecast Graph - In & Out-of-Sample Forecasts**





*Predicted C*  
**Figure 8: Graphical Analysis of Out-of-Sample Forecasts**

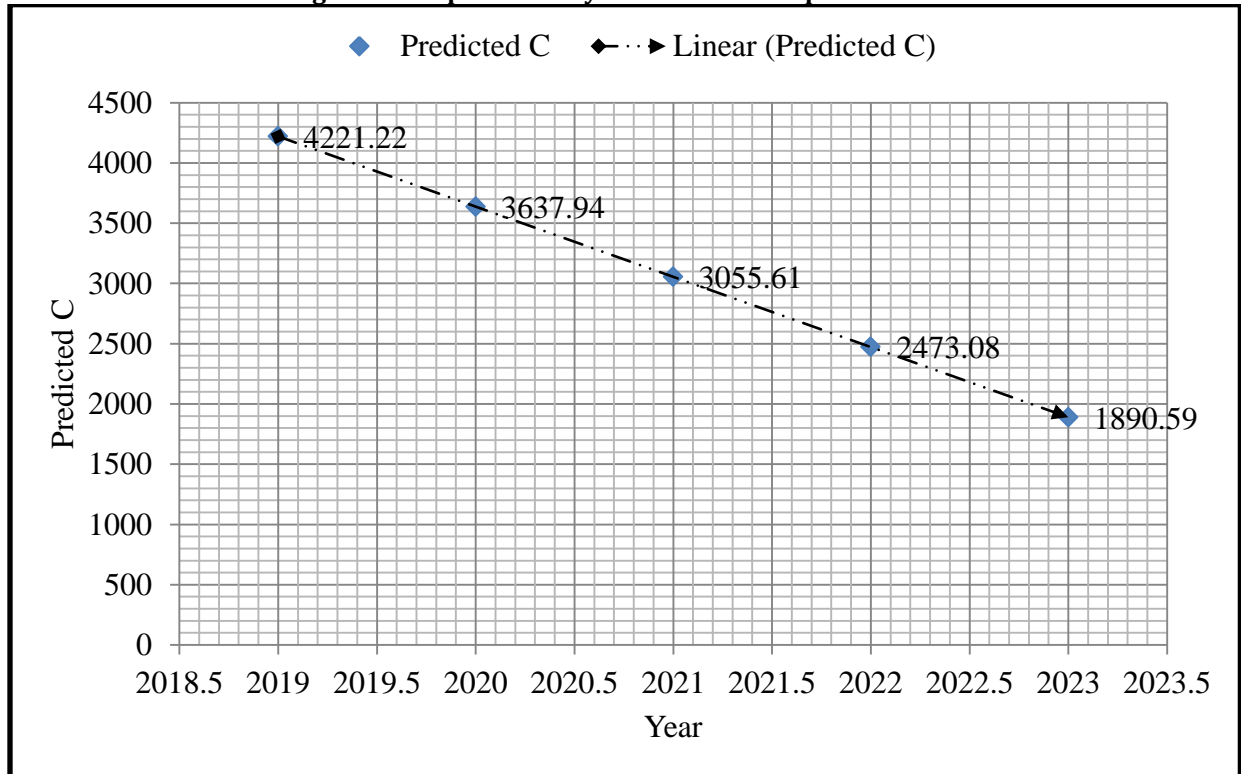


Table 15 shows the main results of the ARIMA (1, 2, 0) model. Figure 7 and 8 are out-of-sample forecasts of the ARIMA (1, 2, 0) model. Years ago, as noted by UNICEF (2009), when the devastating impact of the AIDS pandemic on children was just becoming apparent, there was no way to imagine an AIDS-free generation in the foreseeable future. Fortunately, the results of this study show that it is possible to have an AIDS-free generation in Zimbabwe. As shown in figure 8, the annual number of new HIV infections in children aged 0 to 14, over the out-of-sample period, show a sharply downwards trend. This means that new HIV infections in children (0-14 years old) are expected to drop significantly in the near future. This is quite reasonable and already anticipated, for a developing country like Zimbabwe, where the implementation of HIV-related programs has been consistent over the years. These results are not surprising, but rather consistent with Nyoni & Nyoni (2020). The results of the study are also consistent with Abu & Emeje (2019) who did a similar study in Nigeria. The results of the study are also in line with the estimates done by the

Ministry of Health and Child Care (2018), which provides evidence of a decline in new HIV infections in children. The results of this study also tally with the observation made by Duri *et al.* (2013) that Zimbabwe is one of the few countries in the world currently experiencing a general decline in HIV prevalence.

### Policy Prescription

- i. Prevent HIV infection in parents-to-be. This is arguably the most effective way to reduce the number of children who become infected with HIV. The following strategies can be used:
  - ✓ Correct and consistent condom use.
  - ✓ Voluntary Medical Male Circumcision (VMMC).
  - ✓ Sexual behaviour change.
- ii. Prevent unplanned pregnancies in HIV-infected women.
- iii. Among HIV positive pregnant women, antiretroviral prevention treatment, safe delivery practices and safe infant-feeding options to minimize the risk of MTCT of HIV





should be provided. Hence, the intensification of the PMTCT interventions in the country.

- iv. Offering antiretroviral therapy within 72 hours to victims of rape (sexual abuse).

## 5.0 CONCLUSION

It is possible to materialize an AIDS-free generation in Zimbabwe, despite the fact that HIV/AIDS remains one of the lethal diseases which cause millions of deaths around the globe. It is encouraging to note that much continues to be done on the containing of HIV/AIDS in different parts of Zimbabwe even though the epidemic remains one of the onerous health problems threatening the health system of the country. From this study, the ARIMA (1, 2, 0) model appeared to be the optimal model for analyzing new HIV infections in children (0 – 14 years old) in Zimbabwe. The out-of-sample forecasts show that new HIV infections in children in Zimbabwe will decline over the next 5 years, to as low as 1891 in 2023; especially if control and preventive measures continue to be put in place effectively. Further research may look into applying the ARIMAX model to analyze new HIV infections in children in Zimbabwe. This can potentially uncover interesting results due to the fact that the ARIMAX model is a multivariate version of the ARIMA model and is capable of capturing the impact of other epidemiological factors on new HIV dynamics in children.

## REFERENCES

1. Abu, O., & Emeje, M. A. (2019). A Time Series Model of HIV Prevalence in Nigeria, *Journal of Scientific and Engineering Research*, 6 (9): 120 – 129.
2. Box, G. E. P., & Jenkins, G. M. (1970). *Time Series Analysis: Forecasting and Control*, Holden Day, San Francisco.
3. Dehne, K. L., Dhlakama, D. G., & Richter, L. (1992). Herpes Zoster As an Indicator of HIV Infection in Africa, *Tropical Diseases*, 22 (2): 68 – 70.
4. Demissew, T. G. (2015). *Modeling and Projection of HIV/AIDS Epidemics in Ethiopia Using ARIMA*, Masters Thesis, School of Mathematics, University of Nairobi.
5. Dube, S., Boily, M. C., & Mugurungi, O. (2008). Estimating Vertically Acquired HIV Infections and the Impact of The Prevention of Mother-to-Child Transmission Program in Zimbabwe: Insights From Decision Analysis Models, *Journal of Acquired Immune Deficiency Syndrome*, 48 (1): 72 – 81.
6. Duri, K., Babill, S., & Muller, F. (2013). HIV/AIDS: The Zimbabwean Situation and Trends, *American Journal of Clinical Medicine Research*, 1 (1): 15 – 22.
7. Ferrand, R. A., Corbett, E. L., & Wood, R. (2009). AIDS Among Older Children and Adolescents in Southern Africa: Projecting the Time Course and Magnitude of the Epidemic, *AIDS*, 23 (15): 2039 – 2046.
8. *Global AIDS Response Report (2018). Fast-track Commitments to End AIDS By 2030*, Government of Zimbabwe, Harare.
9. Ikeogu, M. O., Wolf, B., & Matche, S. (1997). Pulmonary Manifestations in HIV Seropositivity and Malnutrition in Zimbabwe, *Archives of Diseases in Children*, 76 (2): 124 – 128.
10. Kuhe, D. A., Chiawa, M. A., & Aboiyar, T. (2016). A Time Series Model of Poverty Incidence in Nigeria, *Journal of Scientific and Engineering Research*, 3 (2): 261 – 283.
11. Mahomva, A. (2007). *Zimbabwe PMTCT Program – Annual Report*, Government of Zimbabwe, Harare.
12. Mapenzauswa, S. (2004). *Zimbabwe Holds First National Meeting on AIDS Crisis*, Reuters News, Harare.
13. *Ministry of Health & Child Care (2014). Zimbabwe National and Sub-national HIV and AIDS Estimates*, Government of Zimbabwe, Harare.
14. *Ministry of Health & Child Care (2018). AIDS & TB Programme – HIV Estimates Report*, Government of Zimbabwe, Harare.
15. *Ministry of Health & Child Welfare (1998). HIV/AIDS in Zimbabwe: Background, Projections, Impact and Interventions*, Government of Zimbabwe, Harare.
16. Nyoni, S. P., & Nyoni, T. (2020). Modeling and Forecasting New HIV Infections at Silobela District Hospital, Zimbabwe: Empirical Evidence From a Box-Jenkins “Catch All” Model, *International Journal of Recent Engineering Research and Development (IJRERD)*, 4 (12): 1 – 10.
17. Nyoni, T. (2018b). Modeling and Forecasting Inflation in Kenya: Recent Insights from ARIMA and GARCH analysis, *Dimorian Review*, 5 (6): 16 – 40.
18. Nyoni, T. (2018a). *Modeling and Forecasting Naira/USD Exchange Rate in Nigeria: A Box-Jenkins ARIMA Approach*, MPRA Paper No. 88622, University Library of Munich, Munich.
19. Nyoni, T. (2018c). *Box – Jenkins ARIMA Approach to Predicting net FDI inflows in Zimbabwe*, MPRA Paper No. 87737, University Library of Munich, Munich.
20. Rubaihayo, J., Tumwesigye, N. M., Konde-Lule, J., & Makumbi, F. (2016). *Forecast Analysis of Any Opportunistic Infection Among HIV Positive*



- 
- Individuals on Antiretroviral Therapy in Uganda, BMC Public Health, 16 (766): 1 – 11.*
21. Takarinda, K. C., Harries, A. D., & Mutasa-Apollo, T. C. (2016). *Critical Considerations for Adopting the HIV “treat all” Approach in Zimbabwe: Is the Nation Poised? Public Health Action, 6 (1): 1 – 5.*
  22. Ticklay, I. M., Nathoo, K. J., Siziya, S., & Brady, J. P. (1997). *HIV Infection in Malnourished Children in Harare, Zimbabwe, East African Medical Journal, 74 (4): 217 – 220.*
  23. Topley, J. M. (1988). *HIV Infection in Zimbabwe, Archives of Diseases in Children, 63 (7): 842 – 844.*
  24. UNAIDS (2002). *Paediatric HIV Infection and AIDS, UNAIDS, Geneva.*
  25. UNICEF (2009). *Children and AIDS: Fourth Stocktaking Report, UNICEF, Geneva.*
  26. UNICEF (2018). *Children, HIV and AIDS, UNICEF, Geneva.*
  27. Yu, H. K., Kim, N. Y., Chu, C., & Kee, M. K. (2013). *Forecasting the Number of Human Immunodeficiency Virus Infections in the Korean Population Using the Autoregressive Integrated Moving Average Model, Osong Public Health Research Perspectives, 4 (6): 358 – 362.*



# ANALYZING ROAD TRAFFIC ACCIDENT RELATED TRAUMA CASES AT KWEKWE GENERAL HOSPITAL IN ZIMBABWE: EMPIRICAL EVIDENCE FROM A BOX-JENKINS SARIMA MODEL

**Dr. Smartson. P. NYONI**

*ZICHIRE Project, University of Zimbabwe, Harare*

**Mr. Thabani NYONI**

*Department of Economics, University of Zimbabwe, Harare*

## ABSTRACT

*This study uses monthly time series data on Road Traffic Accident (RTA) related trauma cases at Kwekwe General Hospital (KGH) from January 2010 to December 2019, to predict RTA related trauma cases over the period January 2020 to December 2021. As verified by unit root tests, the series under consideration is basically an I (1) variable. The study applied the Box-Jenkins approach to time series forecasting and presented the SARIMA (1, 1, 1)(1, 1, 1)<sub>12</sub> model. Residual analysis of this model proves that the model is stable and thus suitable for predicting RTA related trauma cases at KGH over the out-of-sample period. The results of the study reveal that RTA related trauma cases will generally rise at KGH over the out-of-sample period; characterized by seasonal repeats in December each year. The study offers a six-fold policy recommendation in order to help policy makers in improving road safety in Zimbabwe.*

## 1.0 INTRODUCTION

Road Traffic Accident (RTA) is the leading cause of premature death (IFH, 2013) and has now become not only a major public health problem (Peden *et al.*, 2004) but also a serious economic burden (Danlami *et al.*, 2017) and yet the state of roads in Zimbabwe is appalling. The government is failing to cope with the much needed rehabilitation and repairs of roads. This is being fueled by harsh economic conditions prevailing in the country. Potholes are littered around all major roads causing accidents to motorists and pedestrians alike (Mutangi, 2015). Other causes of RTAs include reckless driving, violation of traffic laws (Muvuringi, 2012), human error, vehicle conditions, over-speeding (Aworeni *et al.*, 2010) as well as “*evil*” spirits haunting people (Mhandu & Kazembe, 2012) and many more. Studies, for example, Ursano *et al.* (1999), Mosaku *et al.* (2014) and Fekadu

*et al.* (2019); have shown that RTAs are an important cause of trauma. This study seeks to analyze cases of all patients admitted to a Trauma Unit at Kwekwe General Hospital (KGH) following a road traffic accident.

The majority of RTA deaths in developing countries occur in pre-hospital settings (Mock *et al.*, 2003; Montazeri, 2004). In Zimbabwe, those injured face challenges in accessing healthcare (Muvuringi, 2012). It is an accepted strategy of trauma care that if basic life support, first aid and replacement fluids can be arranged within the first hour of the injury (the golden hour), lives of many of the RTA victims can be saved. The critical factor for this strategy is to provide initial stabilization to the injured within the golden hour. The time between injury and initial stabilization is the most critical period for the patient’s survival. Thus disability and deaths following road accidents are



preventable to some extent (Ministry of Health & Family Welfare, 2018). Prediction of trauma cases resulting from road accidents is an important component of road safety management because it can improve road safety for both travellers and road-safety administrators.

### 1.1 OBJECTIVES OF THE STUDY

- i. To analyze RTA-related trauma cases at KGH over the period January 2010 to December 2019.
- ii. To forecast RTA-related trauma at KGH over the period January 2020 to December 2021.
- iii. To determine whether RTA-related trauma cases are increasing or decreasing at KGH over the out-of-sample period.

### 1.2 RELEVANCE OF THE STUDY

RTAs remain one of the issues that attract a lot of attention throughout the world (Danlami *et al.*, 2017) and have become one of the major causes of trauma in patients. About 50 million people experience RTAs and 1.2 million people in the world are killed annually due to RTAs. In fact, approximately 3000 people die from RTAs daily in the world (Peden *et al.*, 2004). RTAs are expected to increase until they become the seventh top cause of death worldwide by year 2030, if no rigorous action is taken to reduce their occurrence. Approximately 90% of RTA associated deaths and injuries occur in the developing countries (WHO, 2015) such as Zimbabwe. Developing countries in the Sub-Saharan Africa have the highest rates of accidents worldwide. Zimbabwe has been ranked number 126 on world rankings of deaths due to RTAs (WHO, 2014). Despite the increasing rates of RTA occurrences, very few studies have been done in the field of RTAs in Zimbabwe (Njodzi *et al.*, 2016). Furthermore, RTAs strongly contribute to mortality, morbidity and increased inequality among the productive age group and their dependents in Zimbabwe. Fatal road traffic accidents top all the risks and threats of life in the country (Andrews, 2011). At least 3669 people die annually due to RTAs in Zimbabwe (WHO, 2011). Interestingly, road traffic deaths and injuries are predictable and preventable (Ministry of Health & Family Welfare, 2018). This study will model and forecast RTA-related trauma cases at KGH in Zimbabwe. No RTA-related trauma cases have been analyzed and predicted in Zimbabwe so far. The government of Zimbabwe is committed to decreasing the trends of RTA-related trauma cases in the country. To achieve this noble goal, it is not unimportant to

predict RTA-related trauma cases in order to suggest a reliable controlling model.

### 2.0 RELATED PREVIOUS STUDIES

In Iran, Monfared *et al.* (2013) used a monthly time series data set on RTAs covering the period March 2004 – March 2011. The authors applied the Box-Jenkins approach to time series forecasting and presented the ARIMA (0, 1, 2) model as the optimal model for prediction of RTAs. In Zimbabwe, Mutangi (2015) employed ARIMA models in order to analyze RTAs based on an annual data set covering the period 1997 – 2013 and found out that the ARIMA (0, 1, 0) model, that is, the random walk model, was the best model for Zimbabwe's annual traffic accident data. Jorgensen *et al.* (2016) used Exponential models, ARIMA models, negative binomial regression and scenario approaches to estimate possible trends and changes in casualties in two urban areas in Norway over the period 2008 – 2012. They concluded that without strengthened safety strategies, the authorities' 40% casualty reduction target most probably will not be achieved.

Danlami *et al.* (2017) used the Generalized Estimating Equation (GEE) to estimate road fatality based on selected exposure variables. GEE with negative binomial distribution was found to be suitable for use in short term road fatality prediction modeling. Ghedira *et al.* (2018) used ARIMA models to investigate RTAs in Tunisia based on a monthly data set covering the period January 2007 to December 2015 and basically found out that the ARIMA (0, 1, 2) model is the best model and the forecast of their best model shows that the number of RTAs would decrease in Tunisia.

In Saudi Arabia, Alrajhi & Kamel (2019) displays a tutorial for designing a prototype of an interactive analytical tool based on a multivariate LSTM model for time series data to predict future car accidents, fatalities and injuries. Their results indicate increased risk of RTAs in Saudi Arabia. Al-Hasani *et al.* (2019) employed the SARIMA models in order to study RTAs in Oman, based on 228 observations (January 2000 – December 2018), and found out that the SARIMA (0, 1, 2)(1, 0, 1)<sub>12</sub> model was the optimal model. In Australia, Hassouna & Pringle (2019) employed the ARIMA approach in order to analyze and predict crash fatalities based on a data set covering the period 1965 to 2018 and basically found out that, based on gender, the rate of male road fatalities in Australia was significantly higher than that of female road fatalities. The study also found out that the number of



road fatalities for the next 5 years (2019 – 2023) was generally declining.

From the literature review above, clearly no study has been done to forecast RTA-related trauma cases in Zimbabwe or elsewhere. This paper is the first of its kind and is expected to go a long way in improving road safety and minimizing RTA-related trauma cases as well as preventing premature deaths in the country.

### 3.0 METHODOLOGY

In situations where data is collected and framed over a time period, the prediction can best be made using time series techniques. The most popular time

$$\varphi(B^s)\phi(B)\Delta^d\Delta_s^D TC_t = \theta_0 + \gamma(B^s)\theta(B)\alpha_t \dots \dots \dots [1]$$

The non-seasonal factors are given as:

$$\left. \begin{aligned} AR: \phi(B) &= 1 - \phi_1 B - \dots - \phi_p B^p \\ MA: \theta(B) &= 1 + \theta_1 B + \dots + \theta_q B^q \end{aligned} \right\} \dots \dots \dots [2]$$

The seasonal factors are given as:

$$\left. \begin{aligned} Seasonal AR: \varphi(B^s) &= 1 - \varphi_1 B^s - \dots - \varphi_p B^{Ps} \\ Seasonal MA: \gamma(B^s) &= 1 + \gamma_1 B^s + \dots + \gamma_q B^{Qs} \end{aligned} \right\} \dots \dots \dots [3]$$

Where  $TC_t$  is the data series (that is ND),  $\alpha_t$  is the disturbance term, B is the backshift operator,  $\phi$  is the coefficient of the non-seasonal AR,  $\theta$  is the coefficient of the non-seasonal MA,  $\varphi$  is the coefficient of the seasonal AR,  $\gamma$  is the coefficient of the seasonal MA,  $\Delta^d$  is the difference operator, with d order of differencing and  $\Delta_s^D$  is the seasonal difference operator, with D seasonal order of differencing and s length of the seasonal period. In this paper, a SARIMA (p,d,q)(P,D,Q)<sub>12</sub> model was constructed using monthly

series model in accidentology is the Autoregressive Integrated Moving Average (ARIMA) (Brajesh & Shakhar, 2015; Mutangi, 2015; Jorgensen *et al.*, 2016; Danlami *et al.*, 2017; Al-Zyood, 2017; Al-Zyood, 2017; Makridakis *et al.*, 2018; Ghedira *et al.*, 2018; Al-Hasani *et al.*, 2019; Hassouna & Pringle, 2019), whether seasonal, that is; SARIMA (for example, Al-Hasani *et al.*, 2019) or general, that is; simply ARIMA (for example, Hassouna & Pringle, 2019). In this paper, the SARIMA technique is applied. The basic algebraic specification of the SARIMA model applied in this study is as given below:

Trauma cases data from January 2010 to December 2019.

### 3.1 DATA

This study is based on monthly observations of newly recorded and managed Trauma (TC) cases at Kwekwe General Hospital (KGH) in the city of Kwekwe in Zimbabwe, from January 2010 to December 2019. The out-of-sample forecast covers the period January 2020 to December 2021. All the data employed in this study was gathered from KGH.





**3.2 DIAGNOSTIC TESTS AND MODEL EVALUATION**  
**Unit Root Tests: Graphical Analysis**

**Figure 1: Graphical Analysis**

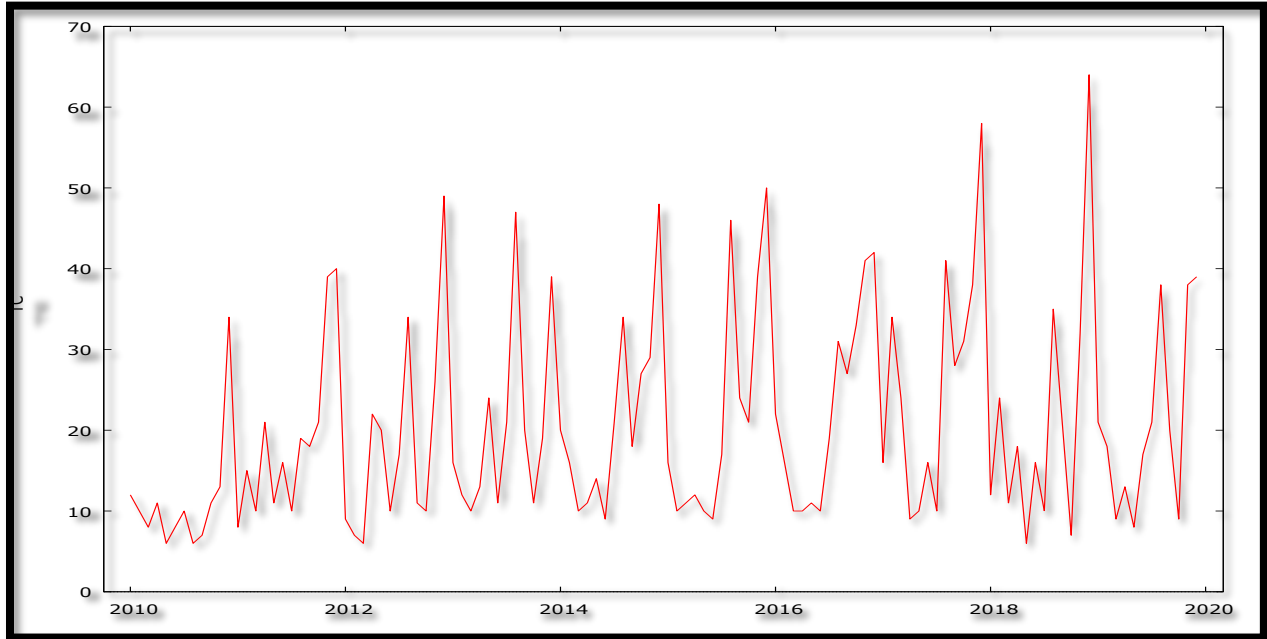


Figure 1 above shows that TC is generally trending upwards, although at a decreasing rate. The series is mostly likely non-stationary in levels. A formal unit root test will be carried out using the Augmented-Dickey-Fuller (ADF) test in order to confirm the level of stationarity. Striking to note, is the fact that there are peaks in almost every month of either August or December each year. This could be

attributed to the fact that these are festive holidays and most people travel during these holidays. This also necessitates the need for a seasonal model to describe this data set; thus the paper applies the Box-Jenkins SARIMA model.

**The ADF Test**

**Table 1: Levels-intercept**

Variable	ADF Statistic	Probability	Critical Values		Conclusion
TC <sub>t</sub>	-2.674360	0.0818	-3.491928	@1%	Stationary
			-2.888411	@5%	Not stationary
			-2.581176	@10%	Not stationary

**Table 2: Levels-trend & intercept**

Variable	ADF Statistic	Probability	Critical Values		Conclusion
TC <sub>t</sub>	-2.082639	0.5492	-4.045236	@1%	Not stationary
			-3.451959	@5%	Not stationary
			-3.151440	@10%	Not stationary

**Table 3: without intercept and trend & intercept**

Variable	ADF Statistic	Probability	Critical Values		Conclusion
TC <sub>t</sub>	0.652846	0.8557	-2.586550	@1%	Not stationary
			-1.943824	@5%	Not stationary
			-1.614767	@10%	Not stationary

**Table 4: 1<sup>st</sup> Difference-intercept**

Variable	ADF Statistic	Probability	Critical Values		Conclusion
D(TC <sub>t</sub> )	-14.05124	0.0000	-3.491928	@1%	Stationary
			-2.888411	@5%	Stationary
			-2.581176	@10%	Stationary

**Table 5: 1<sup>st</sup> Difference-trend & intercept**

Variable	ADF Statistic	Probability	Critical Values		Conclusion
D(TC <sub>t</sub> )	-14.27017	0.0000	-4.045236	@1%	Stationary
			-3.451959	@5%	Stationary
			-3.151440	@10%	Stationary

**Table 6: 1<sup>st</sup> Difference-without intercept and trend & intercept**

Variable	ADF Statistic	Probability	Critical Values		Conclusion
D(TC <sub>t</sub> )	-13.99980	0.0000	-2.586550	@1%	Stationary
			-1.943824	@5%	Stationary
			-1.614767	@10%	Stationary

Tables 1 – 6 indicate that TC is an I(1) variable.

**Evaluation of the SARIMA Models (without a constant)**

Model	AIC	U	ME	MAE	RSME	MAPE
SARIMA (1,1,1)(1,1,1) <sub>12</sub>	<b>747.2870</b>	<b>0.52623</b>	-0.88451	6.0662	7.5874	39.426
SARIMA (1,1,1)(0,1,0) <sub>12</sub>	764.3080	0.57911	-0.9107	6.4787	8.3499	38.201
SARIMA (0,1,0)(1,1,1) <sub>12</sub>	786.4684	0.66835	-0.06364	7.4153	9.2744	43.034
SARIMA (1,1,1)(1,1,0) <sub>12</sub>	757.4175	0.54356	-0.863	6.2311	8.0161	38.354
SARIMA (1,1,0)(1,1,1) <sub>12</sub>	777.5487	0.60882	-0.039106	6.8752	8.8158	41.164
SARIMA (0,1,1)(0,1,1) <sub>12</sub>	751.4687	0.5643	-0.84864	6.343	7.8812	41.518
SARIMA (0,1,1)(1,1,1) <sub>12</sub>	749.8447	0.56284	-0.89933	6.3323	7.7561	41.517
SARIMA (1,1,1)(0,1,1) <sub>12</sub>	748.7948	0.52860	-0.83316	6.1604	7.7149	39.902

A model with a lower AIC value is better than the one with a higher AIC value (Nyoni, 2018b). Furthermore, the Theil's U must lie between 0 and 1, of which the closer it is to 0, the better the forecast method (Nyoni, 2018a). Based on both the AIC and

Theil's U, the study applies the SARIMA (1,1,1)(1,1,1)<sub>12</sub> model.



**Analysis of the Residuals of the SARIMA (1, 1, 1)(1, 1, 1)<sub>12</sub> Model**  
**Residual Correlogram of the SARIMA (1, 1, 1)(1, 1, 1)<sub>12</sub> Model**

**Figure 2: Residual Correlogram**

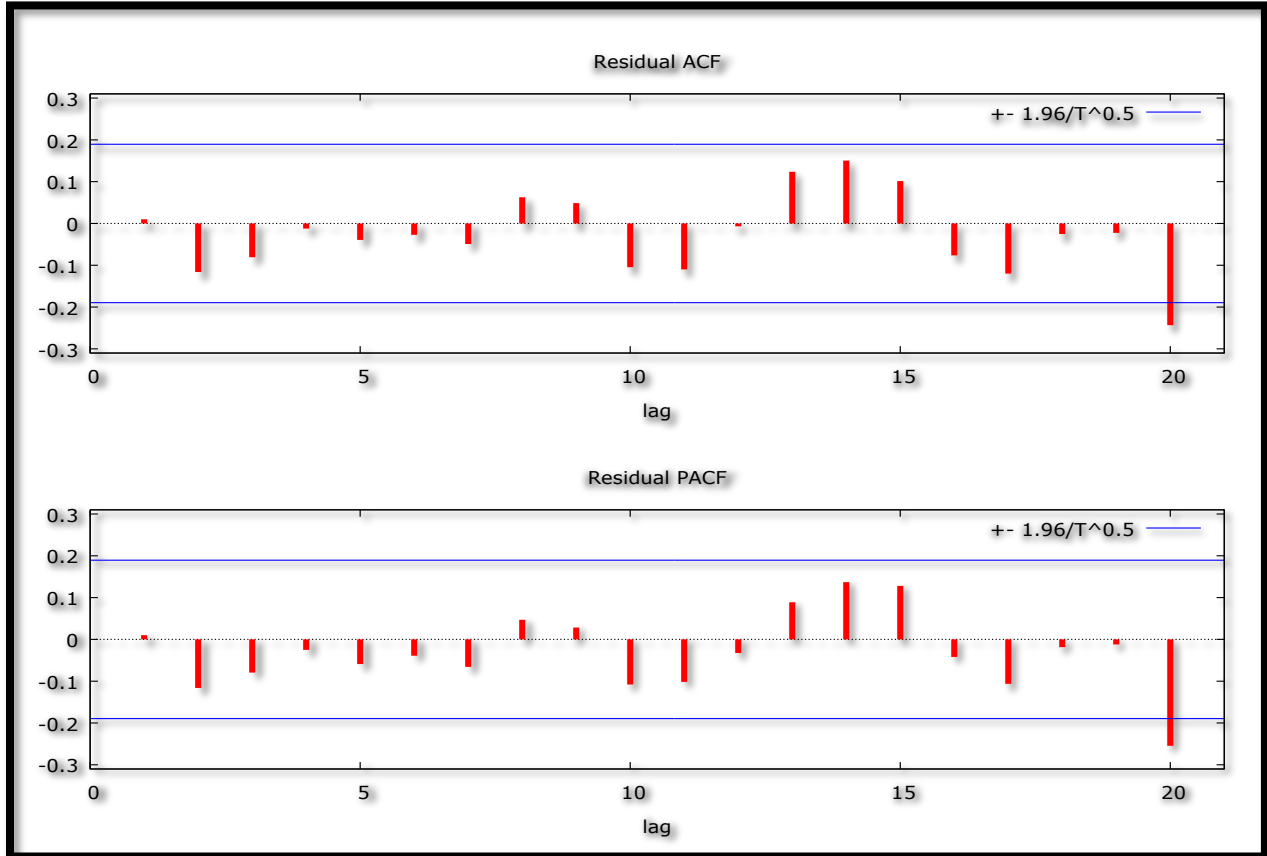
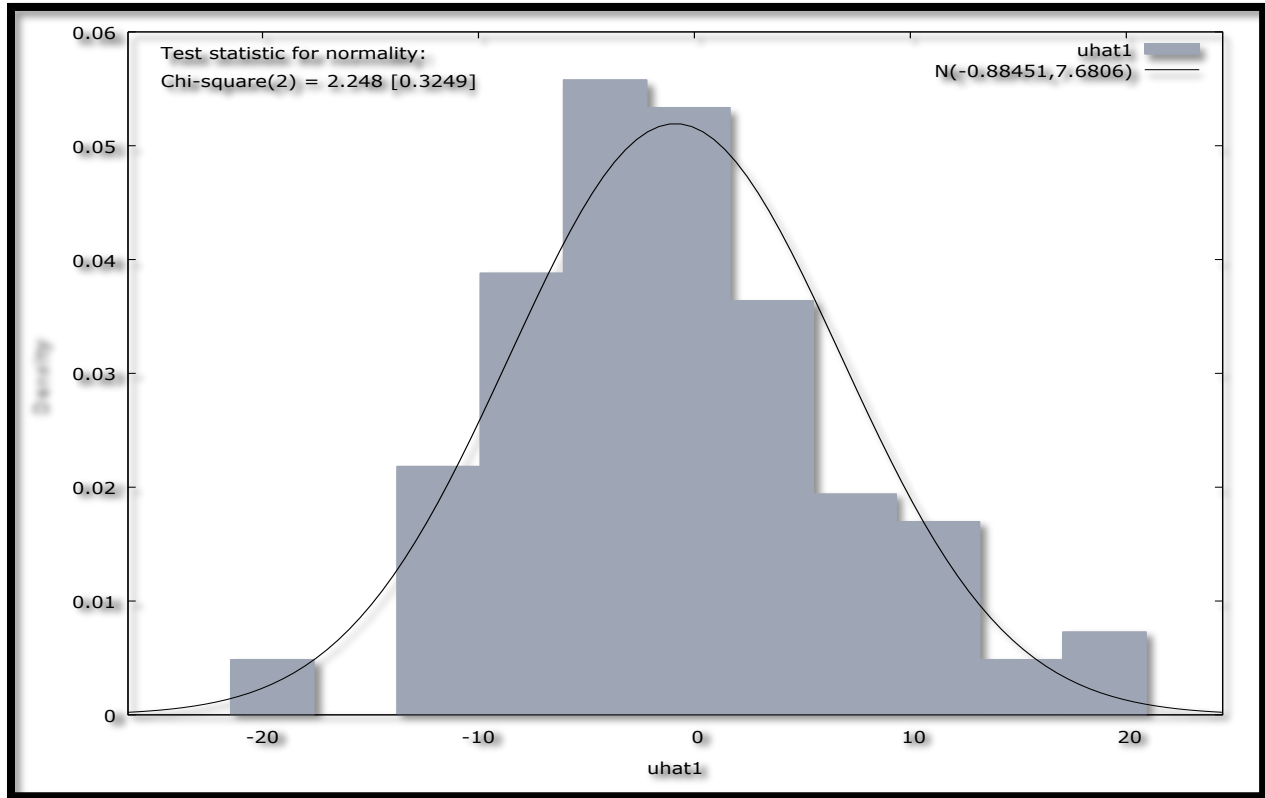


Figure 2 shows that the residuals of the applied model are stable and hence the model is adequate.



**Test for Normality of Residuals**

**Figure 3: Normality Test**



Since the p-value, that is; [0.3249] is statistically insignificant, it implies that the residuals are normally distributed, hence the validity of the normality assumption.

**4.0 RESULTS OF THE STUDY**

**4.1 DESCRIPTIVE STATISTICS**

**Table 7: Summary Statistics, using the observations 2010:01 - 2019:12, for the variable TC (120 valid observations)**

Mean	Median	Minimum	Maximum
20.367	16.500	6.0000	64.000
Std. Dev.	C.V.	Skewness	Ex. kurtosis
12.649	0.62107	1.1482	0.68030

Table 7 shows that the average number of trauma cases over the period under study is 20 cases per month. The minimum number of trauma cases is 6 while the maximum is 64 and was recorded for December 2018.



**4.2 RESULTS PRESENTATION**

**Table 8: Main Results of the SARIMA (1, 1, 1)(1, 1, 1)<sub>12</sub> Model**

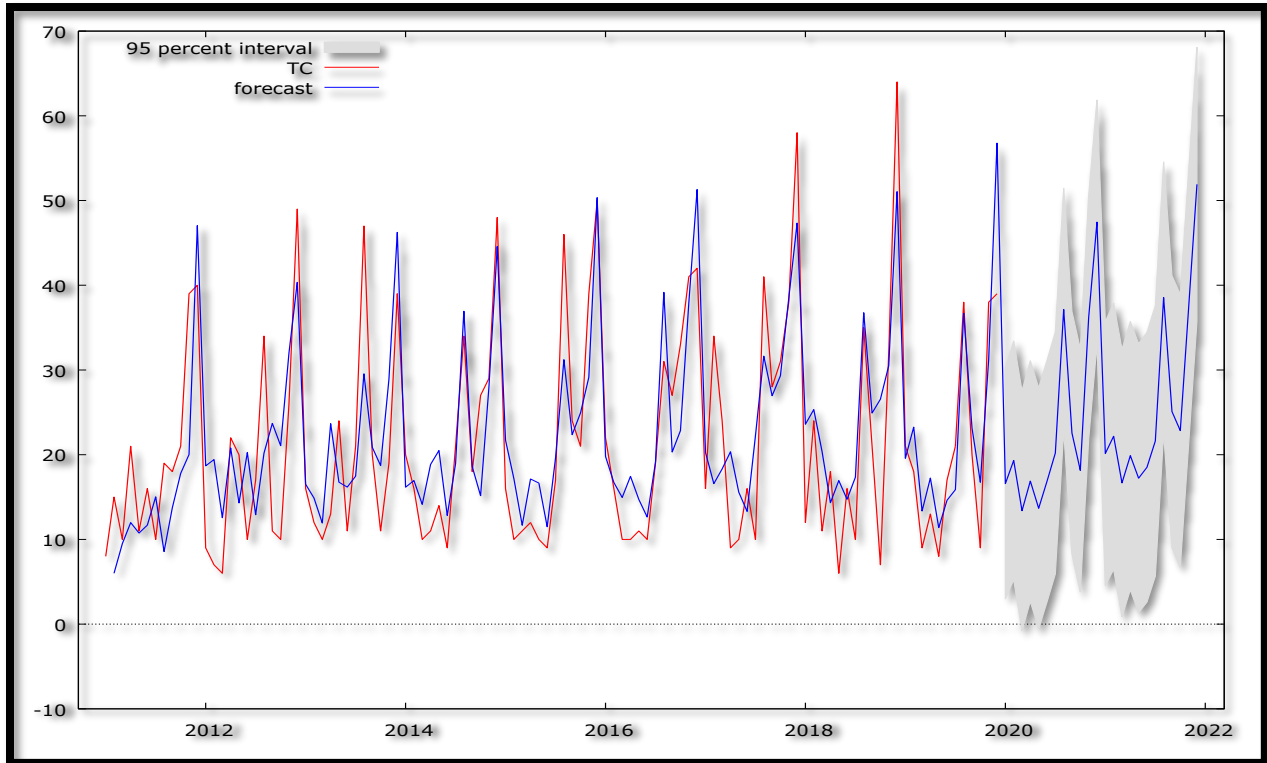
$$(1 - 0.328349B^{12})(1 - 0.221866B)\Delta\Delta_{12}TC_t = (1 - 0.956887B^{12})(1 - 0.951559B)\alpha_t \dots [4]$$

Variable	Coefficient	Standard Error	z	p-value
$\phi_1$	0.221866	0.0990292	2.240	0.0251**
$\varphi_1$	0.328349	0.173536	1.892	0.0585*
$\theta_1$	-0.951559	0.0611343	-15.57	0.0000***
$\gamma_1$	-0.956887	0.649773	-1.473	0.1408

NB: \*\*\*, \*\* and \* imply statistical significance at 1%, 5% and 10% levels of significance

**Forecast Graph**

**Figure 4: Forecast Graph**

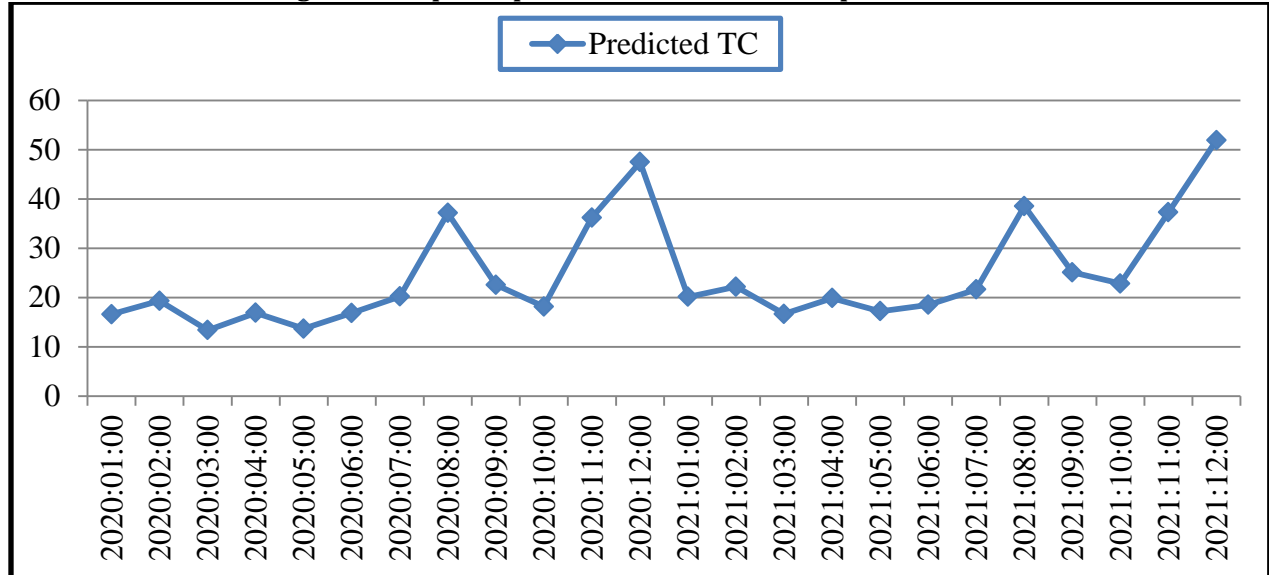






**Out of Sample Forecasts**  
**Table 9: Out-of-sample forecasts**

<b>Year: Month</b>	<b>Predicted TC</b>	<b>Standard Error</b>	<b>95% Confidence Interval</b>
2020:01	16.5817	6.94029	(2.97896, 30.1844)
2020:02	19.3239	7.18937	(5.23303, 33.4148)
2020:03	13.3822	7.22864	(-0.785701, 27.5500)
2020:04	16.8876	7.24612	(2.68548, 31.0898)
2020:05	13.6704	7.25995	(-0.558872, 27.8996)
2020:06	16.8687	7.27300	(2.61386, 31.1235)
2020:07	20.1944	7.28587	(5.91440, 34.4745)
2020:08	37.1434	7.29868	(22.8383, 51.4486)
2020:09	22.5586	7.31146	(8.22840, 36.8888)
2020:10	18.1510	7.32421	(3.79584, 32.5062)
2020:11	36.1925	7.33695	(21.8124, 50.5727)
2020:12	47.4538	7.34966	(33.0488, 61.8589)
2021:01	20.1393	7.94218	(4.57290, 35.7057)
2021:02	22.1813	8.02201	(6.45849, 37.9042)
2021:03	16.6701	8.05351	(0.885483, 32.4546)
2021:04	19.8859	8.07725	(4.05473, 35.7170)
2021:05	17.2257	8.09939	(1.35121, 33.1002)
2021:06	18.5128	8.12113	(2.59568, 34.4299)
2021:07	21.6158	8.14274	(5.65630, 37.5753)
2021:08	38.5477	8.16428	(22.5460, 54.5494)
2021:09	25.0842	8.18575	(9.04040, 41.1280)
2021:10	22.8412	8.20717	(6.75546, 38.9270)
2021:11	37.2845	8.22853	(21.1569, 53.4121)
2021:12	51.9151	8.24984	(35.7457, 68.0845)

**Graphical Presentation of the Predicted Monthly TC Cases at KGH (Out-of-Sample)****Figure 5: Graphical presentation of out-of-sample forecasts**

The main results of the SARIMA (1, 1, 1)(1, 1, 1)<sub>12</sub> model are shown in table 8 above. Equation [4] is the mathematical expression of the model. Striking to highlight is the observation that most parameters of this model are statistically significant. Figures 4 and 5 as well as table 9 basically show out-of-sample forecasts of RTA-related trauma cases at KGH. The predicted RTA-related cases show a generally increasing trend, although the trend increases at a relatively decreasing rate. Striking to note is the fact that the out-of-sample forecasts show a repeat of seasonality in December of each year. This is quite reasonable because most people in Zimbabwe travel during the festive December holidays and during this time, as noted by Muvuringi (2012), most drivers practice reckless driving, probably due to over-excitement associated with the December holidays. The results of this study are a warning signal to policy makers in the country, especially in light of the need to improve road safety and avoid premature deaths and preventable injuries.

#### 4.3 RECOMMENDATIONS

- i. The government of Zimbabwe must capacitate and renovate KGH emergency medical facilities. In this regard, the emergency department should have all the required resuscitation equipment which is functional, including drugs and IV fluids all the time. It is also important for the hospital executive to consider extending the emergency department
- ii. in order to handle large patient volumes in case of a serious bus accident.
- iii. There is need for Basic Life Support ambulances at every 50km along highways such as the Harare – Bulawayo highway. In this regard, KGH should always have a standby rescue operation team. Furthermore, all clinical staff at KGH ought to have regular refresher trainings on emergency preparedness and management, Basic Life Support and Advanced Life Support as well as chest drain insertion for medical officers.
- iv. There is need for specialized skill training to doctors, nurses and paramedics in order for KGH to be in a position to provide speedy and effective RTA-related trauma care.
- v. The government of Zimbabwe must continue spreading awareness regarding injury prevention and road safety. Furthermore, the government of Zimbabwe ought to encourage people to be blood donors in order to save lives of RTA victims and other patients who need blood and blood products urgently.
- vi. The government of Zimbabwe should also tighten the laws governing the driving of public motor vehicles.
- vii. The government of Zimbabwe should improve the way roads are designed, constructed and managed.



## 5.0 CONCLUSION

The costs of road safety to society are substantial and the suffering of the victims and their families huge (Aarts *et al.*, 2016). Road safety remains one of the cardinal objectives of Zimbabwe's transport systems and yet RTA-related trauma cases are generally on the rise! In fact, in Zimbabwe, the prevailing level of RTAs and the consequent trauma cases is not acceptable. These RTA-related trauma cases often claim lives and cause a number of injuries out of which many victims are maimed for life. It has turned out that, especially in relation to RTA-related trauma cases in the country, there is still a significant knowledge gap on the area of modeling and forecasting. This study indicates that RTA-related trauma cases will generally increase at KGH over the out-of-sample period. The planning and implementation of relevant government policy actions should now be hinged on the forecasts of this study.

## REFERENCES

1. Aarts, L.T., Commandeur, R., Welsh, S., Niesen, M., Lerner, P., Thomas, N., & Bos, R. J. (2016). *Study on Serious Road Traffic Injuries in the EU*, European Commission, Brussels.
2. Al-Hasani, G., Khan, A. M., Al-Reesi, H., & Al-Maniri, A. (2019). *Diagnostic Time Series Models for Road Traffic Accidents Data*, *International Journal of Applied Statistics and Econometrics*, 2: 19 – 26.
3. Alrajhi, M., & Kamel, M. (2019). *A Deep-Learning Model for Predicting and Visualizing the Risk of Road Traffic Accidents in Saudi Arabia: A Tutorial Approach*, *International Journal of Advanced Computer Science and Applications*, 10 (11): 475 – 483.
4. Al-Zyood, M. (2017). *Forecast Car Accident in Saudi Arabia With ARIMA Models*, *International Journal of Soft Computing and Engineering*, 7 (3): 30 – 33.
5. Andrews, L. (2011). *Zimbabwe Country Risk Assessment*, ICS, Harare.
6. Aworeni, J. R., Azeez, A., & Olabode, S. O. (2010). *Analytical Studies of the Causal Factors of Road Traffic Crashes in South Western Nigeria*, *International Research Journal of Education*, 1 (4): 118 – 124.
7. Box, G. E. P., & Jenkins, G. M. (1970). *Time Series Analysis: Forecasting and Control*, Holden Day, San Francisco.
8. Brajesh, B., & Shekhar, C. (2015). *Accidental Mortality in India: Statistical Models for Forecasting*, *International Journal of Humanities and Social Science Invention*, 4 (4): 35 – 45.
9. Danlami, N., Napiah, M., Sadullah, A. F. M., & Bala, N. (2017). *An Overview and Prediction of Malaysian Road Fatality: Approach Using Generalized Estimating Equations*, *International Journal of Civil Engineering and Technology*, 8 (11): 452 – 465.
10. Fekadu, W., Mekonen, T., Belete, H., Belete, A., & Yohannes, K. (2019). *Incidence of Post-Traumatic Stress Disorder After Road Traffic Accident*, *Frontiers in Psychiatry*, 10 (519): 1 – 7.
11. Ghedira, A., Kammoun, K., & Saad, C. B. (2018). *Temporal Analysis of Road Accidents by ARIMA Model: Case of Tunisia*, *International Journal of Innovation and Applied Studies*, 24 (4): 1544 – 1553.
12. Hassouna, F. M. A., & Pringle, I. (2019). *Analysis and Prediction of Crash Fatalities in Australia*, *The Open Transportation Journal*, 13: 134 – 140.
13. IFH (2013). *The Global Burden of Disease: Generating Evidence*, IFH, Seattle.
14. Jorgensen, S. H., Jones, A. P., Rundmo, T., & Nordfjaern, T. (2016). *Critical Approaches to Road Injury Trends, Forecasts and Scenarios: Two Urban Cases in Norway*, NTNU, Trondheim.
15. Makridakis, S., Spiliotis, E., & Assimakopoulos, V. (2018). *Statistical and Machine Learning Forecasting Methods: Concerns and Ways Forward*, *PLoS ONE*, 13 (3): 1 – 26.
16. Mhandu, E., & Kazembe, T. (2012). *Urban Myths Pertaining to Road Accidents in Zimbabwe: The Case of Chinhomo Service Centre Along Seke Road (Linking Harare and Chitungwiza)*, *International Journal of Business and Social Science*, 3 (17): 94 – 100.
17. Ministry of Health & Family Welfare (2018). *Capacity Building for Developing Trauma Care Facilities on National Highways*, Government of India, New Delhi.
18. Mock, C., Arreola-Risa, C., & Quansah, R. (2003). *Strengthening Care for Injured Persons in Less Developing Countries: A Case Study of Ghana and Mexico*, *Injury Control & Safety Promotion*, 10 (1): 45 – 51.
19. Monfared, A. B., Soori, H., Mehrabi, Y., Hatami, H., & Delpisheh, A. (2013). *Prediction of Fatal Road Traffic Crashes in Iran Using the Box-Jenkins Time Series Model*, *Journal of Asian Scientific Research*, 3 (4): 425 – 430.



20. Montazeri, A. (2004). *Road-traffic-related Mortality in Iran: A Descriptive Study*, *Public Health*, 118 (2): 110 – 113.
21. Mosaku, K., Akinyoola, A., Olasinde, A., & Orekha, O. (2014). *Predictors of Post-traumatic Stress in Patients Admitted to a Trauma Unit Following Road Traffic Accident (RTA)*, *Journal of Psychiatry*, 17 (3): 1 – 6.
22. Mutangi, K. (2015). *Time Series Analysis of Road Traffic Accidents in Zimbabwe*, *International Journal of Statistics and Applications*, 5 (4): 141 – 149.
23. Muvuringi, M. P. (2012). *Road Traffic Accidents in Zimbabwe, Influencing Factors Impact and Strategies*, 48<sup>th</sup> International Course in Health Development, Royal Tropical Institute, Amsterdam.
24. Njodzi, M., Mugadza, G., Zvinvashe, M., Haruzivishe, C., Ndaimani, A., Mhlanga, M., Rukweza, J., & Kapfunde, A. (2016). *Factors Associated With Road Traffic Accidents Among Survivors: A Pilot Study*, *Journal of Medical and Dental Science Research*, 4 (7): 34 – 41.
25. Nyoni, T. (2018a). *Modeling and Forecasting Naira/USD Exchange Rate In Nigeria: a Box-Jenkins ARIMA Approach*, MPRA Paper No. 88622, University Library of Munich, Munich.
26. Nyoni, T. (2018b). *Modeling and Forecasting Inflation in Kenya: Recent Insights From ARIMA and GARCH Analysis*, *Dimorian Review*, 5 (6): 16 – 40.
27. Peden, M. M., Scurfield, R., & Sleet, D. (2004). *Road Traffic Injury Prevention*, WHO, Geneva.
28. Ursano, R. J., Fullerton, C. S., Epstein, R. S., Crowley, B., & Kao, T. (1999). *Acute and Chronic Post-traumatic Stress Disorder in Motor Vehicle Accident Victims*, *American Journal of Psychiatry*, 156: 589 – 595.
29. WHO (2011). *Distribution of Road Traffic Deaths*, WHO, Geneva.
30. WHO (2014). *Road Traffic Injuries – World Report*, WHO, Geneva.
31. WHO (2015). *Road Traffic Injury Prevention – World Report*, WHO, Geneva.



# **A STUDY TO ASSESS THE LEVEL OF KNOWLEDGE REGARDING ORAL HYGIENE AMONG ADULTS IN JAYAM DENTAL CARE AT PERPERIYANKUPPAM, CUDDALORE DISTRICT**

**Dr.K.Vignesh B.D.S** <sup>(1)</sup>

*Dental surgeon, Jayam dental care at Perperiyankuppam* <sup>(1)</sup>

**Mr.K.Jayaprakash M.Sc (N)** <sup>(2)</sup>

*Lecturer, Department of Psychiatric Nursing, KMC College of Nursing at Trichy* <sup>(2)</sup>

**Mr.A.Anthonisamy M.Sc (N)** <sup>(3)</sup>

*Vice-Principal, Department of Psychiatric Nursing, KMC College of Nursing at Trichy* <sup>(3)</sup>

## **ABSTRACT**

*A descriptive study was to assess level of knowledge regarding oral hygiene among adults in Jayam Dental Care at Perperiyankuppam, Cuddalore District. The objective of the study was to find out the level of knowledge regarding oral hygiene among adults and association between the level of knowledge regarding oral hygiene among adults in selected demographic variables. A non-experimental research design was carried to find the knowledge regarding oral hygiene among adults. The sample size comprised of 60 adults and Convenient sampling technique was used to select the sample. Checklist was prepared. Before collecting the data connect was obtained from each sample. Analysis was planned to be done by using descriptive statistics. The study revealed that 42 (70%) of adults have adequate knowledge, 12 (20%) of the adults have moderate knowledge and 6 (10%) of adults have inadequate knowledge on oral hygiene. Majority of peoples neglect the two times brush per day and oral care. Women pay more attention to oral hygiene and they have more own teeth than men. Young dentists need to be educated in order to provide appropriate dental care to the elderly. It is essential to conduct on more activities teaching modalities to enable the clients to participate in their lifestyle and also this study can be useful for health for health personnel to improve their knowledge and practice among adults.*

**KEYWORDS:** *Assess, knowledge, oral hygiene, adult, Socio-demographical variable.*

## **INTRODUCTION**

“Poor oral health care can result in poor overall health”.

- George Taylor

Health is the level of functional and metabolic efficiency of a living organism. In humans it is the ability of individuals or communities to adapt and self-manage when facing physical, mental or social changes. The World Health Organization (WHO) defined health in its broader sense in its 1948 constitution as “a state of complete physical, mental, and social well-being and not merely the absence of

disease or infirmity.” Children are the precious gift who is considered to be a resource for future. Healthy children of today will be a healthy citizen for tomorrow.

The oral cavity is an important part of the body, and it plays a crucial role in chewing, swallowing, speaking, and in forming facial expressions as well as maintaining nutritional status, systemic health, and self-esteem. Oral hygiene is directly linked to systemic infections, autoimmune disorders, chronic cardiovascular disease, glucose control in diabetes, nutritional intake and other diseases. These chronic





diseases can affect a person's quality of life, especially the ability to eat, speak, taste, and swallow; in addition, they can cause the psychological instability and significant pain.

Age-related lesions and dental problems stem from the occurrence of certain factors including the following: alveolar process atrophy, dental caries, reduced daily salivation and xerostomia, tooth loss, oral cancer, denture acceptance difficulties resulting from advanced oral mucosal diseases, lesions in the denture bearing areas (alveolar and osseous) and local and systemic diseases.

According to American Dental association policy defines oral health as functional, structural, aesthetic, physiologic and psychosocial state of well being and is essential to an individual's general health and quality of life.

Dental caries is a major oral health problem in most industrialized countries, affecting 60-90% of school children and the vast majority of adults.<sup>6</sup> Dental problems are one of the leading problems of children. Oral hygiene is an essential component for prevention of dental diseases.

**Vellappally-Sajith et al.**, Describe different forms of tobacco usage and its direct relationship with the prevalence of dental diseases. Older adults are likely to take medications that can impact oral health and affect dental treatment. Hundreds of common medications, including antihistamines, diuretics, pain killers, high blood pressure medications and antidepressants, can cause side effects such as dry mouth, soft tissue changes, taste changes, and gingival overgrowth. Women who are menopausal or post-menopausal may experience changes in their mouths. Recent studies suggest that estrogen deficiency can place post-menopausal women at higher risk for severe periodontal disease and tooth loss. In addition, hormonal changes in older women may result in oral discomfort including dry mouth, pain and burning sensations in the gingiva and altered taste.

Many analytical studies in public health have examined socio-demographic characteristics such as age, race, sex, and socioeconomic status; relatively few have investigated the influence of behaviour and lifestyle characteristics on the oral health of older populations.

The aim of the research was to assess the state of dentition and hygiene habits in the adults group of study population of Cuddalore District.

## STATEMENT OF THE PROBLEM

A study to assess the level of knowledge regarding oral hygiene among adults in Jayam Dental Care at Perperiyankuppam, Cuddalore District.

## OBJECTIVES

- To assess the level of knowledge regarding Oral hygiene among adults.
- To find the association between the level of knowledge regarding Oral Hygiene adults in selected socio-demographic variables.
- To prepare the health education pamphlets to the adults.

## RESEARCH METHODOLOGY

### RESEARCH APPROACH

For the present study quantitative approach has been selected.

### RESEARCH DESIGN

For the current study non-experimental design was selected.

### VARIABLES

Independent variable:

Oral hygiene among adults.

Dependent variable:

Knowledge regarding oral hygiene.

### SETTING OF THE STUDY

The study was carried out in Jayam Dental Care situated in Perperiyankuppam.

### POPULATION

In this study target population comprise of adults.

### SAMPLING

#### SAMPLE

The sample for the present study was who are come to the jayam dental care, were selected to participated in this study.

#### SAMPLE SIZE

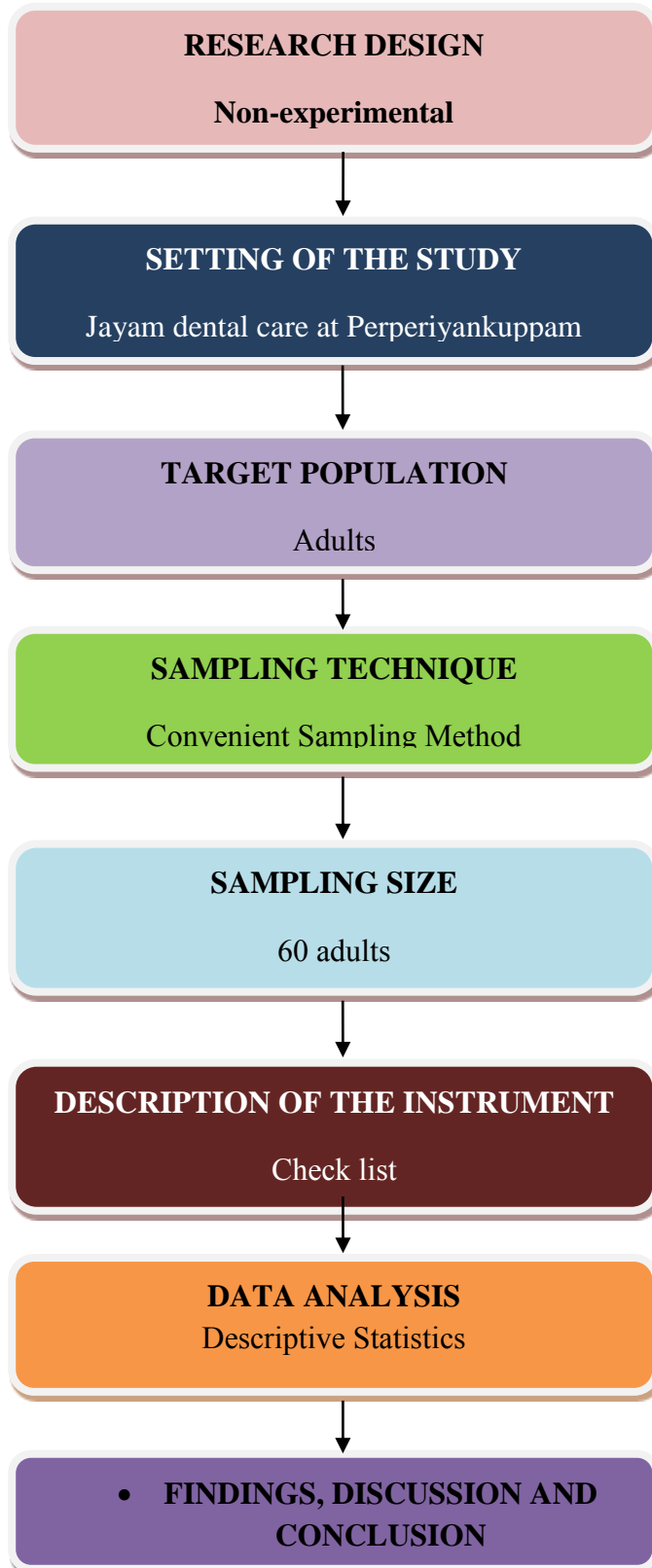
The sample size comprised of 60 adults, Jayam dental care at Perperiyankuppam.

### SAMPLING TECHNIQUE

Convenient sampling technique was used to select the sample for the present study.



**SCHEMATIC REPRESENTATION OF RESEARCH DESIGN**



**DESCRIPTION OF TOOLS**

Tools consist of two parts,

**SECTION-I: SOCIO-DEMOGRAPHIC DATA**

It consists of Age, Sex, Religion, Education, Domicile, Occupation, Family Income per month, Type of family, Type of house and Sources of the information about oral hygiene.

**SECTION-II: Structured knowledge questionnaire.**

It includes the items related to oral hygiene from their subject.

**SECTION-III: CHECKLIST ON KNOWLEDGE REGARDING ORAL HYGIENE**

It includes the items related to maintenance of oral hygiene.

**SCORING PROCEDURE**

There were 30 items pertaining to the knowledge on oral hygiene. Each item has 2 options that includes agree and disagree. Agree carries 2

marks, disagree carries 1 mark. The maximum score was 60. The level of knowledge was categorized based on the percentage of score obtained.

**TRANSLATION OF TOOL**

Validated tools were translated into Tamil language.

**DATA ANALYSIS AND INTERPRETATION**

The chapter deals with analysis of data on level of knowledge regarding oral hygiene among adults Jayam dental care at Perperiyankuppam. The data collected from 60 samples were analyzed using descriptive statistics. The results are presented under following actions.

**ORGANIZATION OF DATA**

Section I: Socio-Demographic variables of adults.

Section II: Asses the knowledge regarding oral hygiene.

Section III : Association regarding oral hygiene among adults with selected socio-demographical variables

**SECTION I: TABLE FREQUENCY AND PERCENTAGE DISTRIBUTION OF SOCIO-DEMOGRAPHIC VARIABLES**

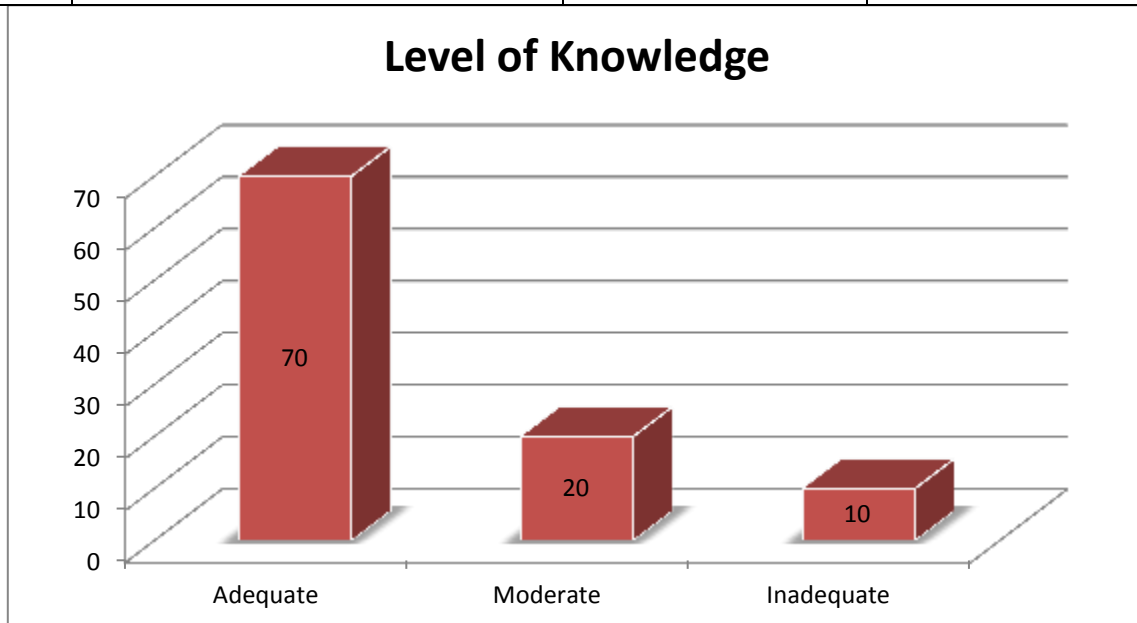
S.NO	SOCIO-DEMOGRAPHIC VARIABLE	FREQUENCY	PERCENTAGE (%)
1.	Age		
	a) 18-40 years	23	38.3
2.	b) 41-64 years	37	61.7
	Sex		
3.	a) Male	50	83.3
	b) Female	10	16.7
4.	Religion		
	a) Hindu	41	68.3
	b) Christian	17	28.3
	c) Muslim	2	3.3
5.	d) Others	0	0
	Education		
	a) Illiterate		18.3
	b) Primary education	11	45.0
	c) Secondary education	27	35.0
6.	d) Diploma /degree	21	1.7
	Domicile		
	a) Rural	1	
7.	b) Urban		83.3
	Occupation	50	16.7
8.	a) Coolie	10	
	b) Government employee	41	68.3
	c) Private employee	2	3.3
	Family Income per month	17	28.3
	a) Rs 3001-6000		



9.	b) Rs 6001-10000	26	43.3
	c) Above Rs 10,001	26	43.3
	Type of family	8	13.3
10.	a) Nuclear family		
	b) Joint family	56	93.3
	Type of house	4	6.7
	a) Kacha house		
	b) Pucca house	9	15.0
	c) Thatched house	47	78.3
	Sources of the information about oral hygiene	4	6.7
	a) News paper & Magazine	8	13.3
	b) Friends & Family members	30	50.0
c) Radio & Television	20	33.3	
d) Health personnel	2	3.3	

**SECTION II: FREQUENCY AND PERCENTAGE DISTRIBUTION OF LEVEL OF KNOWLEDGE REGARDING ORAL HYGIENE AMONG ADULTS**

S.NO	LEVEL OF KNOWLEDGE	FREQUENCY	PERCENTAGE(%)
1.	Adequate	42	70
2.	Moderate	12	20
3.	Inadequate	6	10



The finding shows that the maximum 42(70%) adults are having adequate knowledge regarding oral hygiene, 12(20%) adults are having moderate knowledge and 6(10%) adults are having inadequate knowledge.

**SECTION III : ASSESSMENT OF ASSOCIATION REGARDING ORAL HYGIENE AMONG ADULTS WITH SELECTED SOCIO-DEMOGRAPHICAL VARIABLES**

S.NO	Demographical variable	Chi-square value	P Value	Level of significance
1.	Age	13.371	0.001	significant
2.	Sex	9.394	0.009	significant
3.	Religion	1.944	0.746	NS
4.	Education	4.047	0.670	NS
5.	Domicile	9.394	0.009	significant
6.	Occupation	1.944	0.746	NS
7.	Family Income per month	17.780	0.001	significant
8.	Type of family	1.913	0.384	NS
9.	Type of house	6.594	0.138	NS
10.	Sources of the information about oral hygiene	6.321	0.388	NS

\*-significant at 5% ( $p < 0.05$ ) level.

**SUMMARY OF THE ASSOCIATION**

- ❖ The above table shows that there are statistically significant association between the level of knowledge, age, sex, domicile and Family Income per month.
- ❖ There is no significant association between the level of knowledge regarding oral hygiene among adults religion, education, occupation, type of family, type of house and Sources of the information about oral hygiene.

**CONCLUSION**

The study concluded that 42 (70%) adults have adequate knowledge, 12 (20%) adults have moderate knowledge and 6 (10%) adults have inadequate knowledge on oral hygiene.

**The findings of this study do suggest that:**

1. Majority of peoples neglect the two times brush per day and oral care.
2. Women more often practice oral hygiene and they have more own teeth than men.
3. The most frequent cause of oral hygiene neglect in the older adults could be gender, the socio-economic conditions, behaviour habits and lack of sufficient health education.
4. The dentist may need to consult with the patient's GP the development of the appropriate personalised treatment plan in older adults patients.
5. Young dentists need to be educated in order to provide appropriate dental care to the older adults.

**BIBLIOGRAPHY****Book reference**

1. Denise F Polit (2004), *Nursing Research Principles And Methods*, 7<sup>th</sup> edition Philadelphia, Lippincott publishers, Page no:283-287.

2. Suresh K Sharma(2011), *Nursing Research And Statistics*, 8<sup>th</sup> edition, Haryana: Rajkamal Electric Press Page no:93-94.
3. Gray, Shirley (2004), *Personal Hygiene And Good Health*, 2<sup>nd</sup> edition, Child World Publishers, Page no:323-326.
4. Kidol (2005), *Essential of Dental Carries*, 1<sup>st</sup> edition, Oxford university publishers, Page no:484-489.
5. Terri Kyle (2008), *Essential Of Pediatric Nursing*, 1<sup>st</sup> edition, workers Kluwer publishers, pvt.ltd, New Delhi, Page no:223-226.
6. Park.K.(2007), *Textbook of Preventive And Social Medicine*, 9<sup>th</sup> edition, BanarsidasBhanot, Jabalpur, Page no:34-35.

**Journal references**

1. I.Taylor GW, Loesche WJ, Terpenning MS. Impact of oral diseases on systemic health in the elderly: diabetes mellitus and aspiration pneumonia. *J Public Health Dent.* 2000 Fall;60(4):313-20.
2. Li X, Kolltveit KM, Tronstad L, Olsen I. Systemic diseases caused by oral infection. *Clin Microbiol Rev.* 2000 Oct;13(4):547-58.
3. Zubelewicz-Szkodzińska B, Szkodziński J, Danikiewicz A, Błażelonis A, Muc-Wierzoń M, Muryn Z. Effects of simvastatin in old patients with hypercholesterolemia. *Kardiol Pol.* 2003;59:470-3. (In Polish.)
4. Sapp JP, Eversole LR, Wysocki GP. *Contemporary oral and maxillofacial pathology.* 2nd ed. St. Louis: Mosby; 2004.
5. Genco RJ. Current view of risk factors for periodontal diseases. *J Periodontol.* 1996 Oct;67(10 Suppl):1041-9.
6. Vellappally S, Fiala Z, Šmejkalová J, Jacob V, Shriharsha P. Influence of tobacco use in dental caries development. *Cent Eur J Public Health.* 2007 Sep;116-21.
7. Kaur M. School children knowledge regarding dental hygiene. *Int J Advancements Res Technol* 2013.



8. Anwar JM, Ali MS, Leghari M, Tariq J. Oral hygiene knowledge and source of information among 12 to 16 years old Karachu school children. *Pak Oral Dent J* 2015
9. Kamran K, Bakhteyar K, Heydari H, Lotfi A, Heydari Z. Suvey of Oral Behaviors, Knowledge and Attitude among School Children: A Cross-sectional Study from Iran. *Int J Health Sci* 2014
10. American Dental Association Policy, Definition of Oral Health. Available from: [www.ada.org/en/about-ada/ada-positions-policies-and-statements/ada-policy-definition-of-oral-health](http://www.ada.org/en/about-ada/ada-positions-policies-and-statements/ada-policy-definition-of-oral-health)





# DESIGN, ANALYSIS AND COMPARISON OF VARIOUS MATERIALS FOR CONNECTING ROD

**Sumant R Balli**

*Mechanical engineering, K.L.E Institute of Technology, Hubli, India*

**Prajwal Shetty**

*Mechanical engineering, K.L.E Institute of Technology, Hubli, India*

**S.C.Sajjan**

*Faculty Department Mechanical Engineering, K.L.E Institute of Technology, Hubli, India*

Article DOI: <https://doi.org/10.36713/epra4760>

## ABSTRACT

Connecting rod is engine component which transmits motion from piston to the crankshaft and serves as lever arm. The function of connecting rod is to convert piston's reciprocal movement into rotary motion of the crankshaft. Connecting rod generally made from Carbon steel and Aluminium alloys have been used in recent days and some different materials are finding its application. The performance connecting rod in automobile engine is influenced by its design and weight for production of durable, cheaper and light connecting rod, hence optimization and analysis of connecting rod. The 3D model of connecting rod is designed and developed using CATIA V5. In proposed approach different materials compared like Aluminium alloy 7075, Magnesium alloy, Titanium alloys (Ti-3Al-2.5V) and beryllium alloy (25) are taken for the analysis of connecting rod and factors like Stress, Strain and Deformation were obtained. The purpose of this study is identify best materials for connecting rod, after analysing at ANSYS APDL 15.0.

**KEYWORDS** : Connecting rod, CATIA V5, ANSYS APDL15.0, Aluminium alloy 7075, Magnesium alloy, Titanium alloy (Ti-3Al-2.5V) and Beryllium Alloy (25).

## I. INTRODUCTION

For connecting pistons to the crankshaft, the connecting racks are used. The upper end of rod oscillates while lower end or big end rotates. It converts reciprocating motion piston into rotary motion the crankshaft. A combination of axial and bending stresses acts on the rod in operation. The axial stresses are due to gas pressure in the cylinder and inertia force caused by the reciprocating motion. Bending stresses are used due to the centrifugal effects. The rod has an I-beam cross section to give the highest stiffness and minimum weight. The tendency in vehicle development drove the invention and execution of very new material which are light and meet plan prerequisites. Lighter connecting rod helps to diminish lead brought about by force of inertia in engine as it doesn't require big balancing weight of crankshaft. Use of metal matrix composite unable safety increases and progresses that prompts successful utilization of feel and to get high engine power.

It is necessary for designers to find out the stresses present

within the connecting rod, to bear the load even in worst situation without failing completely. Hence it is required to analyze the strain intensity, stress concentration and deformation in the piston end of the connecting rod. The specification parameter or measurement of connecting rod is determined based on the working parameter on chosen vehicle. The model of connecting rod components is then designed and finally evaluated by FEA method and result thus obtained will give necessary results of work carried out here.



**FIG 1: Connecting rod**

**II. PROBLEM DEFINITION**

In the proposed approach the main aim is to plan and enhance connecting rod dependent on its material properties by associating connecting rod with various materials like Aluminium alloy 7075, Magnesium alloy, Titanium alloy (Ti-3L-2V) and Beryllium alloy (25). Based on the results of analysis the connecting rod is designed CATIA V5 and analyzed in ANSYS APDL 15.0 software after study, the current material and alternate materials are compared and the optimal performance outcome are recommended for the connecting rod in terms of stresses, strain and deformation.

**III. CALCULATION**

Considering Activa 6G two wheeler vehicle specification for designing of connecting rod.

*A. Calculation of Pressure*

- Engine type : 4-Stroke air cooled engine
- Bore × Stroke : 47 × 63.1 mm
- Displacement : 109.5mm
- Maximum power : 7.6 bph @ 8000 rpm
- Maximum torque : 8.79 N-m @5250 rpm
- Compression ratio : 10.0±0.2 : 1
- Auto ignition temperature : 60° F ( 288.55 K )
- Density of petrol : 0.77 kg/L = 7.7 × 10<sup>-7</sup> kg/mm<sup>3</sup>
- Molecular weight of petrol : 114.28 g/mole = 0.11428

kg/mole

$$\begin{aligned} \text{Mass} &= \text{Density} \times \text{Volume} \\ &= 7.7 \times 10^{-7} \times 109.5 \\ &= 0.0843100 \text{ kg} \end{aligned}$$

From gas equation

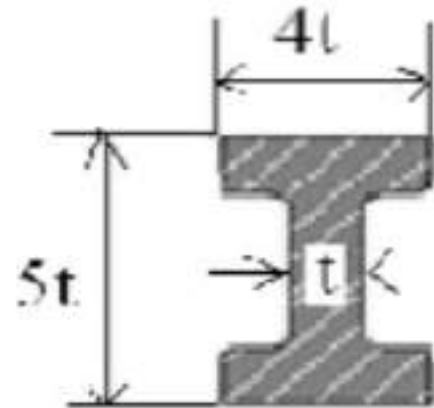
PV= MRT

$$R_{\text{specific}} = \frac{R_x}{MW} = \frac{8.3143}{0.114228} = 72.786$$

$$P = \frac{MR_s T}{V} = \frac{0.11 \times 72.76 \times 288.55}{109.5} = 21.11 \text{ MPa}$$

B. Design calculation for Connecting rod

Thickness of flange and web of the section = t  
Width of section B = 4t  
Standard dimension of I-section



Height of section H = 5t  
Area A = 2(4t × t) + (3t × t) = 11t<sup>2</sup>  
Moment of inertia of section about X-axis

$$\begin{aligned} I_{xx} &= \frac{1}{12} \times 4t \times (5t)^3 \\ &= \frac{419}{12} (t^4) \end{aligned}$$

Moment of inertia of section about Y-axis

$$\begin{aligned} I_{yy} &= \frac{2}{12} \times t \times (4t)^3 + \frac{1}{12} (3t)^3 \\ &= \frac{131}{12} (t^4) \end{aligned}$$

$$\frac{I_{xx}}{I_{yy}} = 3.2$$

Length of connecting rod (L) = 2 times the stroke  
L = 2 × 63.1 = 126.2 mm

Total force acting F = F<sub>p</sub> - F<sub>i</sub>

$$\begin{aligned} F_p &= \frac{\pi}{4} \times d^2 \times \frac{\pi}{4} \times 63.1^2 \times 10.55 \\ &= 32991.42 \text{ N} \end{aligned}$$

$$F_i = m\omega^2 r \left( \cos\theta + \frac{\cos 2\theta}{2} \right)$$

$$\omega = 2 \times \frac{\pi N}{60} = 2 \times \pi \times \frac{8000}{60} = 837.76 \text{ rad/s}$$

$$\text{Crank radius} = \frac{46.5}{2} = 23.25 \text{ mm}$$

$$n = \frac{l}{r} = \frac{126.2}{23.25} = 5.43 \text{ mm}$$

$$F_i = 0.084322 \times 837.76^2 \times 23.25 \times 10^{-3} \times \left( 1 + \frac{1}{5.43} \right)$$

$$F_i = 1629.36 \text{ N}$$

$$\begin{aligned} F &= F_p - F_i \\ &= 32991.42 - 1629.36 \end{aligned}$$

$$F = 31362.06 \text{ N}$$

Buckling load W<sub>B</sub> = Maximum gas force × FOS

$$W_B = \frac{\sigma_c \times A}{1 + \alpha \left( \frac{L}{K_{xx}} \right)^2}$$

$$K_{xx} = \sqrt{\frac{I_{xx}}{A}} = \sqrt{\frac{34.91t^4}{11t^2}} = 1.78t$$

$$\alpha = \frac{\sigma_c}{\pi^2 E} = \frac{160}{\pi^2 \times 45} = 3.6025 \times 10^{-4}$$



$$W_B = \frac{160 \times 11t^2}{1 + 3.6025 \times 10^{-4} \left(\frac{126.2}{1.78t}\right)}$$

$$31362.06 = \frac{160 \times 11t^2}{1 + 3.6025 \times 10^{-4} \left(\frac{126.2}{1.78t}\right)}$$

t = 4.41 mm  
 Width B = 4t = 4 × 4.41 = 17.64 mm  
 Height H = 5t = 5 × 4.41 = 22.05 mm  
 Area A = 11t<sup>2</sup> = 11 × 4.41<sup>2</sup> = 213.92 mm<sup>2</sup>  
 Height at piston end H<sub>1</sub> = 0.825H  
 = 0.825 × 22.05  
 = 18.191 mm  
 Height at crank end H<sub>2</sub> = 1.175H  
 = 1.175 × 22.05  
 = 25.9087 mm  
 Diameter of piston D = 47 mm

**C. Design of small end**

Load on piston pin or small end  
 $F_p = d_p l_p \times P_{bp}$   
 $d_p$  = Inner diameter of small end  
 $l_p$  = Length of piston pin = 1.5  $d_p$   
 $P_{bp}$  = Bearing pressure = 10 MPa  
 1032991.42 = 1.5  $d_p \times d_p \times 10$   
 $d_p = 46.89 \cong 47$  mm  
 $L_p = 1.5 \times 47 = 70.5$  mm  
 Outer diameter of small end =  $d_p + 2t_b + 2t_m$   
 = 47 + (2 × 3) + (2 × 5)  
 = 63 mm

**D. Design of big end**

Load on crank pin  $F_p$  = Projected area × bearing pressure  
 $F_p = d_c l_c \times P_{bc}$   
 32991.42 = 1.25  $d_c \times d_c \times 7.5$   
 $d_c = 59.32 \cong 60$  mm  
 $L_c = 1.25 d_c = 1.25 \times 60 = 75$  mm  
 Outer end of crank end =  $d_c + 2t_b + 2t_m + 2d_b$   
 Where,  
 Thickness of bush  $t_p = 3-5$  mm  
 Marginal thickness  $t_m = 5-10$  mm  
 Marginal thickness bolt = 3 – 6 mm  
 = 60 + (2 × 4) + (2 × 5) + (2 × 4)  
 = 86 mm

**Design of bolt**

Force on bolt =  $\frac{\pi}{4} \times (d_{cb})^2 \times \sigma_t \times n_b$   
 Where,  
 $d_{cb}$  = Core diameter of bolts  
 $\sigma_t$  = Allowable tensile stress of the bolt = 12 MPa  
 $n_b$  = 2 bolts  
 $F = \frac{\pi}{4} \times (d_{cb})^2 \times 12 \times 2$   
 $F = 18.85 d_{cb}^2$   
 1629.36 = 18.85 ×  $d_{cb}^2$   
 $d_{cb} = 9.29$  mm  
 Normal diameter =  $\frac{d_{cb}}{0.84} = \frac{9.29}{0.84} = 10.93$  mm

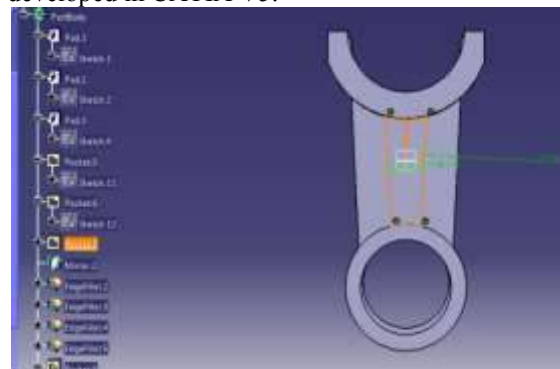
Hence we use M12 size bolt.

**TABLE I. MATERIAL PROPERTIES**

Sl.NO.	Materials	Young's Modulus (GPa)	Poisson's ratio	Density (kg/m <sup>3</sup> )
1	Aluminium alloy-7075	71.7	0.33	2180
2	Beryllium alloy(25)	125	0.3	8250
3	Magnesium alloy	45	0.3	1810
4	Titanium alloy	100	0.3	4480

**IV. MODELLING AND ANALYSIS**

From obtained dimensions 3-D model of connecting rod is developed in CATIA V5.



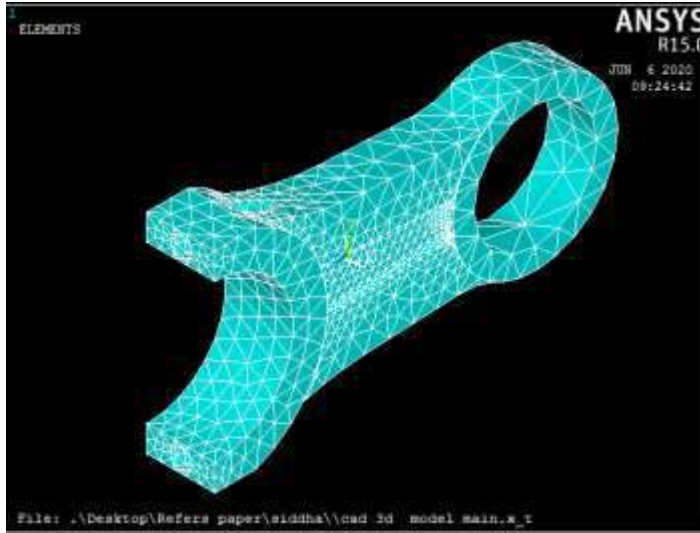
**Fig 2: Modeling of connection rod**



**Fig 3: Complete model of connecting rod**

### 1) Meshing

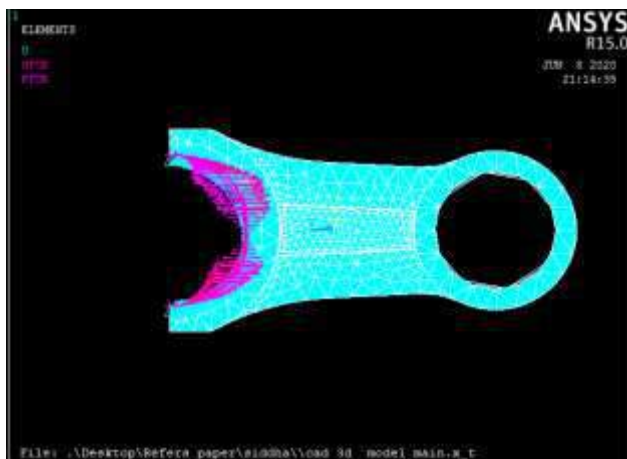
For meshing of the model, smart size was taken 6. No. of elements were 2 and total no. of nodes are 767571 as shown in fig (4).



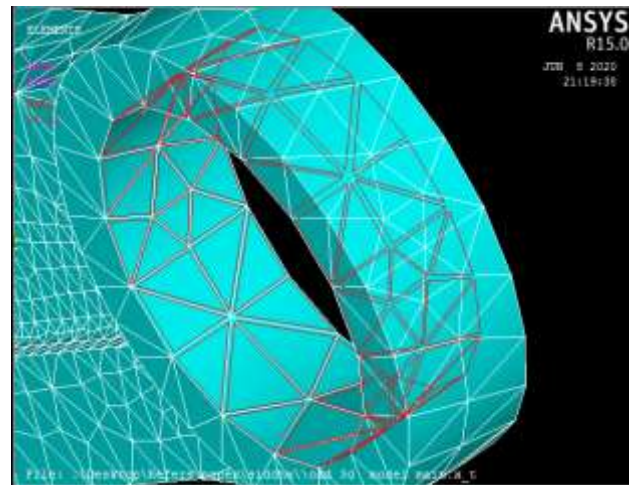
**Fig 4: Meshed Model**

### 2) Apply the boundary condition

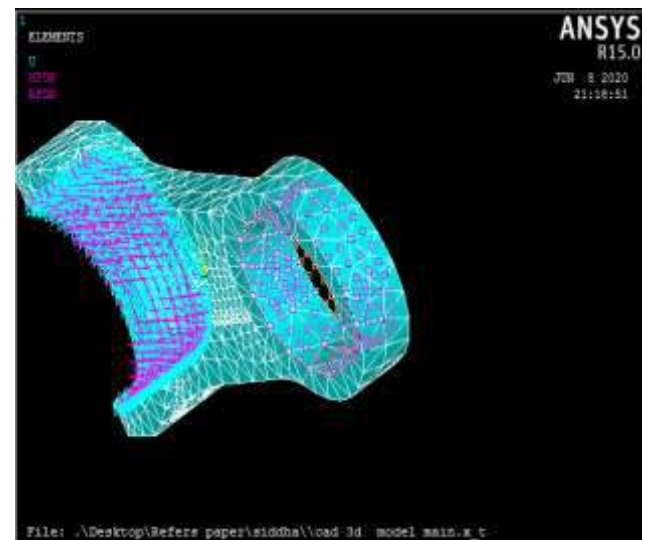
In the ansys we applied the boundary condition. Crank end of the connecting rod fixed as shown in below fig(5). For the finite element analysis 21.11 Mpa of pressure is applied as shown in fig(6). The pressure is applied at the piston end of connecting rod keeping crank end fixed. The maximum and minimum Von-mises stress, strain and displacement are noted from the ANSYS.



**Fig 5: Crank end is fixed**



**Fig 6: Pressure applied on piston end**



**Fig 7: Fixed end and pressure applied end**

## V. RESULTS AND DISCUSSION

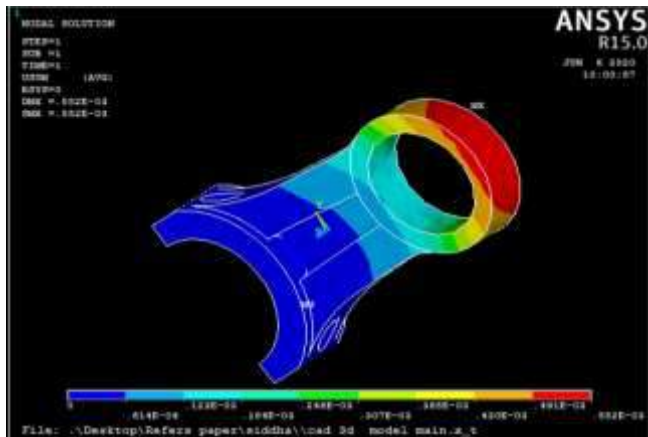
For FEA analysis 21.11 MPa pressure is applied at piston end and crank end was constrained in all degrees of freedom. The maximum and minimum Von-mises stress, elastic strain and deformation were noted from ANSYS 15.0 APDL software.

Materials used for analyzing of connecting rod:

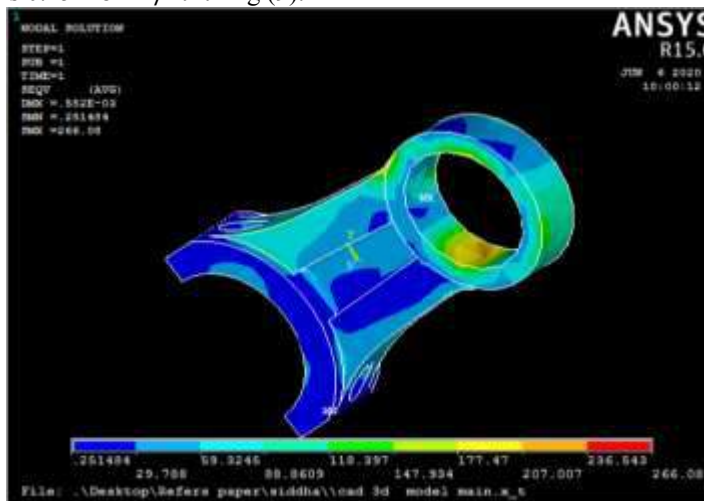
1. Aluminium alloy-7075

Maximum total deformation occurs at piston end of connecting rod is  $0.552 \times 10^{-3}$  mm fig (8).

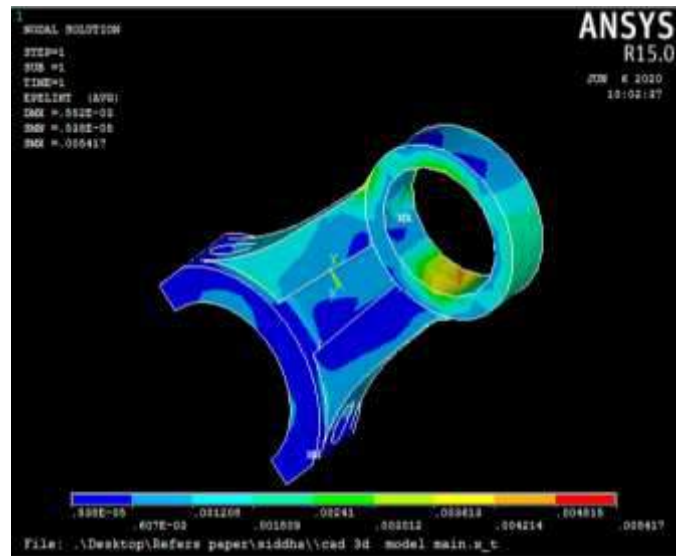


**Fig 8: Deformation output of Aluminium alloy-7075**

The maximum stress at piston end of connecting rod is  $266.08 \text{ N/mm}^2$ . The minimum stress at piston end of connecting rod is  $0.251484 \text{ N/mm}^2$  fig (9).

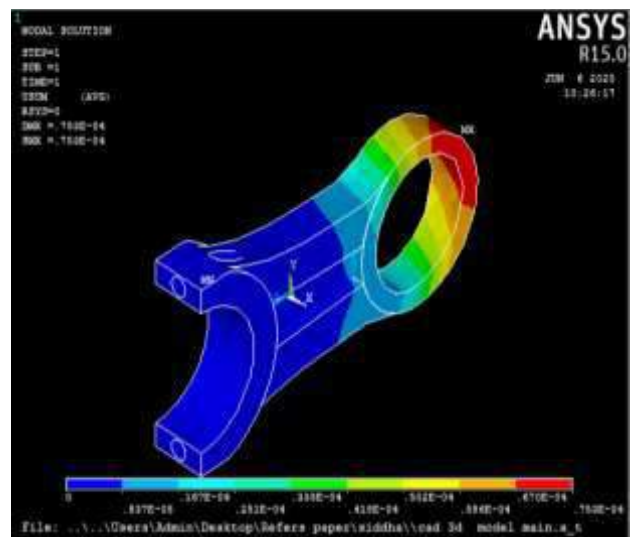
**Fig 9: Von-mises stress output of aluminium alloy-7075**

The maximum strain at piston end of connecting rod is  $0.5417 \times 10^{-2}$ . The minimum strain at piston end of connecting rod is  $0.538 \times 10^{-5}$  fig (10).

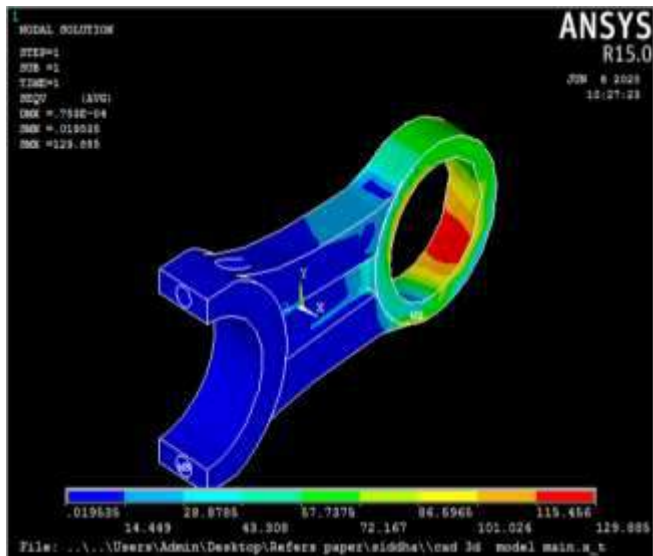
**Fig 10: Strain output of Aluminium alloy-7075**

## 2. Beryllium alloy (25)

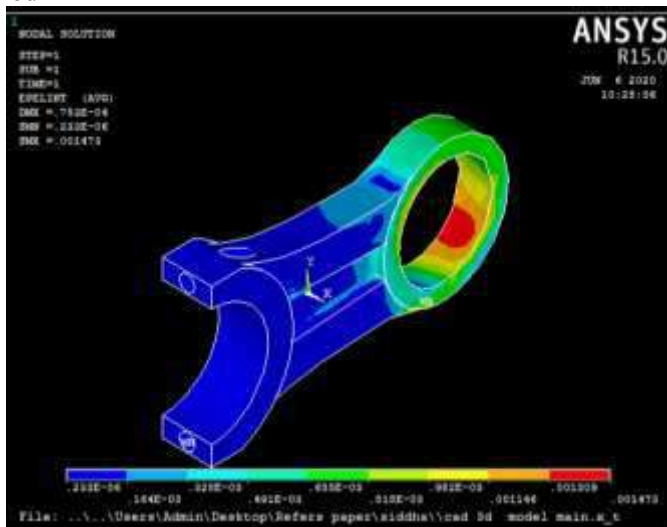
Maximum total deformation occurs at piston end of connecting rod is  $0.753 \times 10^{-4} \text{ mm}$  fig (11).

**Fig 11: Deformation output of Beryllium alloy (25)**

The maximum stress at piston end of connecting rod is  $129.885 \text{ N/mm}^2$ . The minimum stress at piston end of connecting rod is  $0.019535 \text{ N/mm}^2$  fig (12).

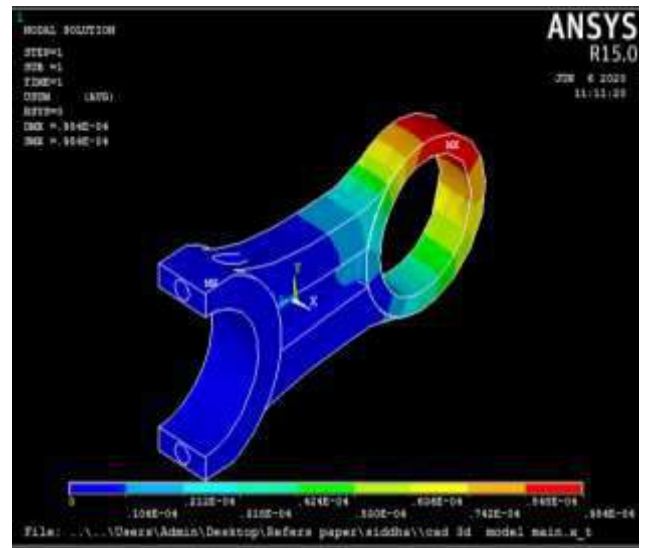
**Fig 12: Von-mises stress output of Beryllium alloy(25)**

The maximum strain at piston end of connecting rod is 0.001473. The minimum strain at piston end of connecting rod

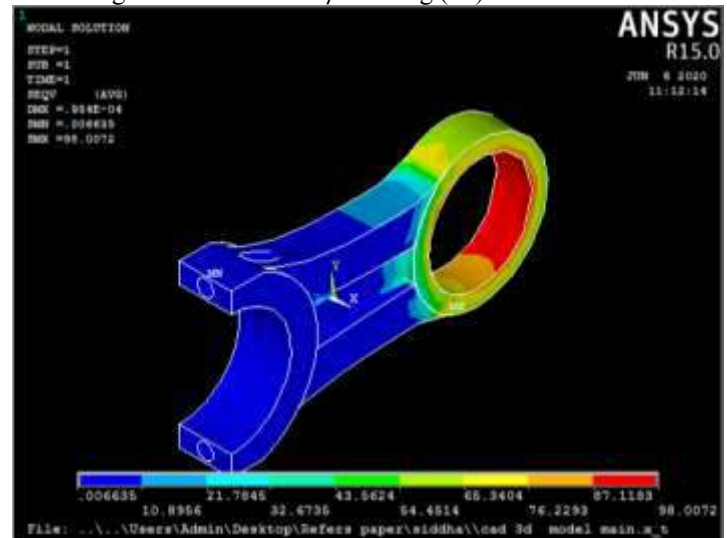
**Fig 13: Strain output of Beryllium alloy(25)**

### 3. Magnesium alloy

Maximum total deformation occurs at piston end of connecting rod is  $0.954 \times 10^{-4}$  mm fig (14).

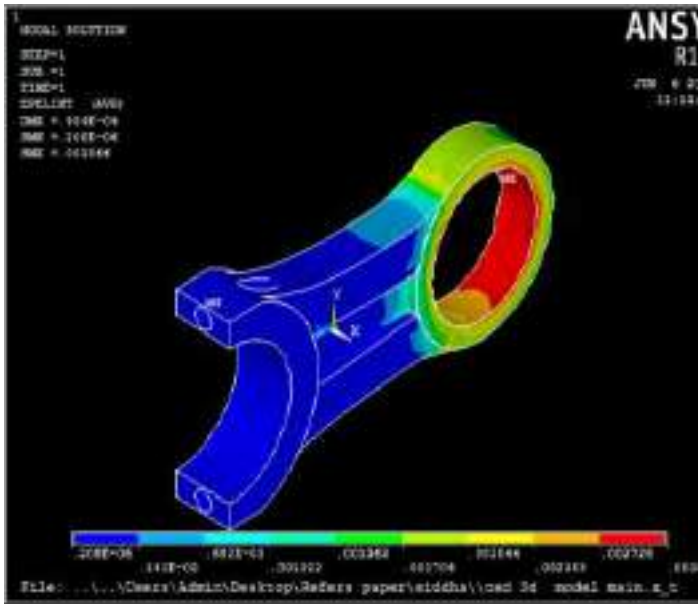
**Fig 14: Deformation output of Magnesium alloy**

The maximum stress at piston end of connecting rod is  $98.0072 \text{ N/mm}^2$ . The minimum stress at piston end of connecting rod is  $0.006635 \text{ N/mm}^2$  fig (15).

**Fig 15: Von-mises stress output of Magnesium alloy**

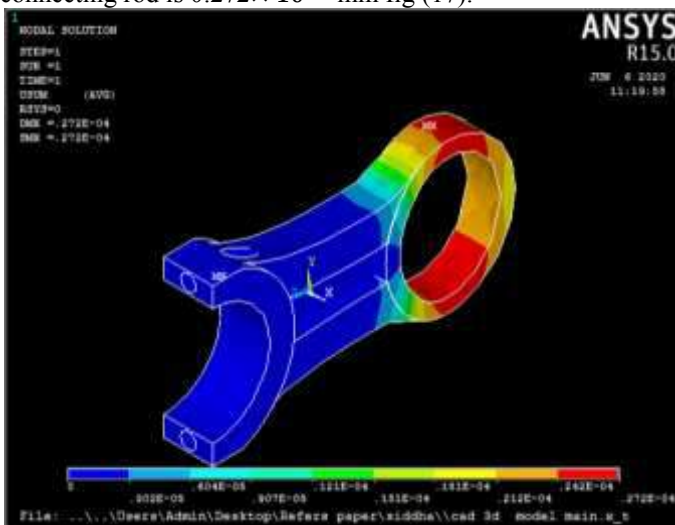
The maximum strain at piston end of connecting rod is 0.00306. The minimum strain at piston end of connecting rod is  $0.20 \times 10^{-6}$  fig (16).



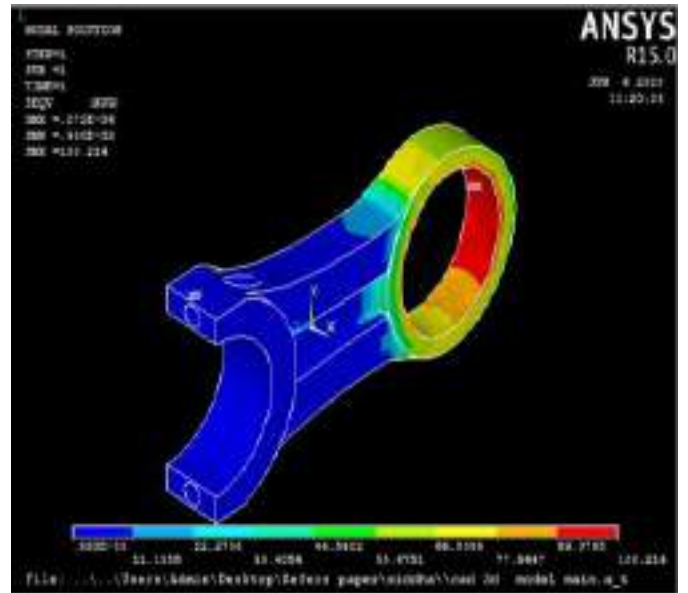
**Fig 16: Strain output of Magnesium alloy**

#### 4. Titanium alloy (Ti-3Al-2.5V)

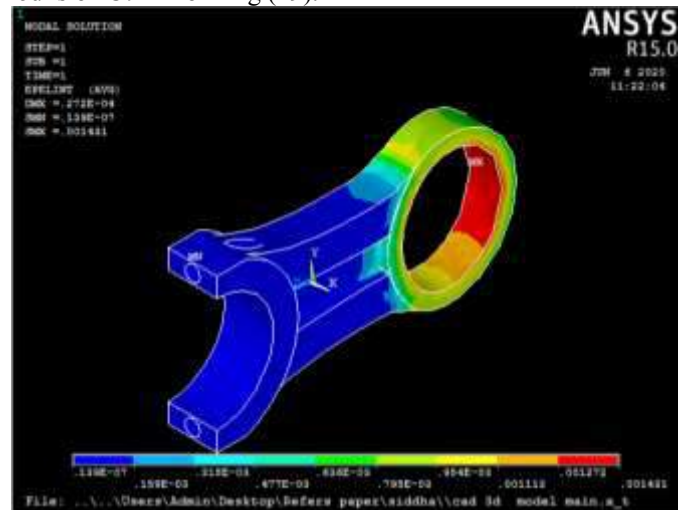
Maximum total deformation occurs at piston end of connecting rod is  $0.272 \times 10^{-4}$  mm fig (17).

**Fig 17: Deformation output of Titanium alloy**

The maximum stress at piston end of connecting rod is  $100.214 \text{ N/mm}^2$ . The minimum stress at piston end of connecting rod is  $0.0930 \times 10^{-3} \text{ N/mm}^2$  fig (18).

**Fig 18: Von-mises stress output of Titanium alloy**

The maximum strain at piston end of connecting rod is 0.001431. The minimum strain at piston end of connecting rod is  $0.139 \times 10^{-7}$  fig (19).

**Fig 19: Strain output of Titanium alloy**

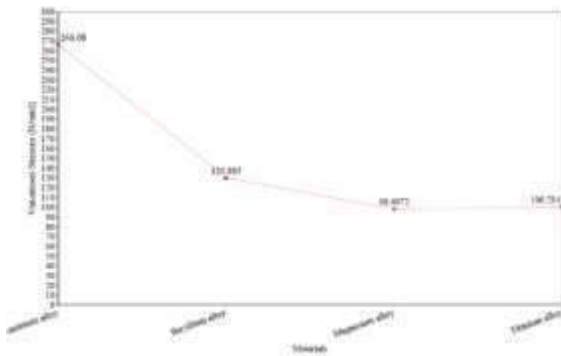
**TABLE II. COMPARISON OF FEA RESULTS**

Sl.NO.	Materials	Von-mises stress (N/mm <sup>2</sup> )	Elastic Strain Intensity (× 10 <sup>-2</sup> )	Deformation (mm) (× 10 <sup>-4</sup> )
1	Aluminium alloy-7075	266.08	0.5417	5.52
2	Beryllium alloy(25)	129.885	0.1473	0.753
3	Magnesium alloy	98.0072	0.3066	0.954
4	Titanium alloy (Ti-3Al-2.5V)	100.214	0.1431	0.272

Comparison of FEA results as shown in above table is plotted in graph.

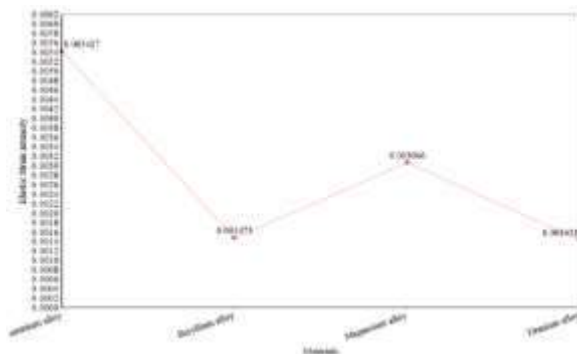
Comparison of different materials

1) Stress



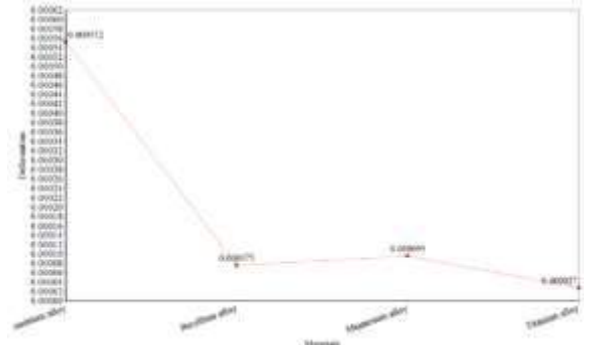
**Fig 20: Stress comparison chart**

2) Strain



**Fig 21: Strain comparison chart**

3) Deformation



**Fig 22: Deformation comparison**

**VI. CONCLUSION**

In this analysis the pressure on the piston head were applied and its effect on connecting rod was studied.

- In the proposed approach Aactiva 6G vehicle specification has been considered for designing of connecting rod.
- In CATIA V5 solid modeling of connecting rod was rendered in accordance with production drawing specification and pressure effect analysis was conducted in ANSYS 15.0 APDL for stress, strain and deformation.
- In static analysis the crank end was fixed and piston end was under pressure, it is found that maximum stress was developed at piston end.
- From above material property point of view the Magnesium alloy and Aluminium alloy-7075 are having less density compared to the Beryllium alloy(25) and Titanium alloy(Ti-3Al-2.5V).
- By observation of ANSYS analysis the maximum Von-mises stress, elastic strain intensity and deformation found minimum in Magnesium alloy.
- Hence, according to study Magnesium alloy can be used for production of connecting rod in two wheelers.

**VII. REFERENCES**

1. Singiresu Rao “ The Finite element in engineering 4<sup>th</sup> edition” ebook ISBN: 9780080470504, 6<sup>th</sup> December 2004.
2. N.P.Dhoshi et.al, “ Analysis of connecting rod using analytical and FEM”, International journal of modern engineering research (IJMER), vol.3, ISSUE-1, ISSN: 2249-6645, January-February 2013.
3. Ritesh Kumar Patel 2014 “ Finite element analysis pf connecting rod using CAE tools”, Master’s Thesis, National Institute of Technology, Kurukshetra.
4. A Muhammad et al, “ Finite Element Analysis of connecting rod in ANSYS”, IOP conf.series: Materials science and engineering 736(2020) 022119.
5. Ruchir Shrivastava “ Finite Element analysis of connecting rod for two wheeler and optimization of suitable material under static load condition”, International Research Journal of Engineering and Technology (IRJET), vol-04, e-ISSUE: 2395-0056, February 2017.
6. Gurnath V Shinde et al “ Stress analysis of connecting rod using FEA”, Researchgate publication, February 2005.
7. Ashwini Mane et al “ Finite Element Analysis and Design optimization of connecting rod”, International Journal of



*Engineering Research and Application (IJERA), vol-6, ISSUE-7, ISSN: 2248-9622, July 2016.*

8. *K Mahadevan and Balaveera Reddy- Design Data Hand Book- CBS Publication, 4th Edition, 2013.*
9. *Suraj Pal et al “ Design Evaluation and optimization of connecting rod parameters using FEM ” International Journal of Engineering and Management Research (IJEMR), vol-2, Issue-6, ISSN: 2250-0758, December-2012.*
10. *Pranav G Charkha et al “ Analysis and optimization of connecting rod” second international conference of emerging trends in engineering and technology, December-2009.*



## HISTORY OF CREATION SOVIET OF KARAKALPAK STATEHOOD

**Djumashev A.**

*Candidate of historical sciences (PhD), senior researcher, Head of the Department History  
Karakalpak research Institute of Humanities Karakalpak branch of the Academy of  
Sciences, Republic of Uzbekistan, Nukus, Uzbekistan*

Article DOI: <https://doi.org/10.36713/epra4776>

### ABSTRACT

*The purpose of the research is to reveal the features of the creation of the Soviet Karakalpak state. The article considers the processes of formation of the Karakalpak Autonomous region and its subsequent transformation from an independent region to an independent Republic. The conditions for administrative division in the Soviet state are shown. The article focuses on the fact that the entry of Karakalpakstan directly into Russia in the mid-1930s accelerated the process of transformation of Karakalpakstan from an independent region to an independent Republic. It is also noted that one of the reasons for joining Karakalpakstan to Russia and after its transformation into a political autonomy was the popular uprisings and rallies that took place in 1929-1930 in Karakalpakstan, directed against the Soviet government. The scientific novelty of the work is that based on the identified new archival documents, it is determined that the level of economic, political and cultural development of Karakalpakstan allowed it to obtain political autonomy. As a result of this research, the stages that the Karakalpak people went through during the existence of the Soviet-type state are analyzed in detail.*

**KEYWORDS:** *the Soviet government, the state, the administrative-territorial division, national division, Karakalpakstan, an Autonomous region, the transformation.*

### INTRODUCTION

Formation of the Karakalpak independent area (further - KIA) and the transformation involved it from independent area in independent republic attracted attention of both historians, and lawyers, public figures, publicists. However some aspects of this process are insufficiently covered by the researchers, engaging in the given problem. Till today the extensive scientific literature including the large monographies and generalizing works on given problem [2]. However is saved as show the new archival documents, revealed by us many aspects of this rather interesting problem remained outside of a field of sight of these authors, and they are rather valuable sources for disclosing the given question.

### DISCUSSION

In Soviet state there were "rules" of administrative - territorial division or so-called Soviet autonomies, which existed in two forms: administrative and political. Number first included independent areas, together with the national

districts, and in the second structure were only independent republics. Later the last could be transformed to allied republics. For successful passage of all these forms of administrative - territorial division it was necessary strictly to observe these "rules".

Between administrative and political autonomies there were distinctions consisting in the following: the administrative autonomy was distributed only to sphere of management, and the political autonomy was embodied in the independent national state, which was characterized in more significant volume of the rights, presence of the own constitution, supreme bodies of state authority, legislation, government etc.

Today it is generally accepted to consider, that created in 1922 at CC CPT(b) of the Khorezm republic the Kazakh-Karakalpak department, which literally in one year was transformed to independent area, was a first step on ways of restoration uniform Karakalpak national state of the Soviet type.



April 5, 1924 CC CPT(b) at preliminary session has considered and has discussed the offer of the Central Asian Bureau CC CPT(b) (further - CAB) about national delimitation of Central Asia and in the decisions from June 12, September 25 and October 11, 1924 has assigned on CAB a management of all party and Soviet work on delimitation and organization created republics [1].

In middle of June, 1924 in Tashkent the Responsible secretary CC CPT(b) I.M.Vareikis said on the radio, that expansion and the deepening of national state construction of Central Asia has revealed necessity of national delimitation. That is, formation in territory of Turkestan, Bukhara, Khorezm - Uzbek, Turkmen, Kirghiz (Kazakh) republics, two independent areas of the Kara-Kirghiz (Kirghiz) and Tadjiks.

For broadest populations of ideas of national delimitation, and also with the purposes of attraction of broad masses to discussion and development of the new state device, CAB CC CPT(b) offered to discuss at all party assemblies the general theses of national delimitation. Here it is necessary to pay attention that "broad masses" are there are those who participates on "party assemblies". Campaign of party discussion should begin immediately and finish by August 25 so that by September 1 were called plenums RC, on which the results of all these discussions should be moved.

After the message of Vareikis, A.Dosnszrov (outstanding state figure of Karakalpakstan), which at will of destiny was in Tashkent and was at the centre of all occurring events, not waiting reaction from a management Amudaria of area, he himself actively participated in process of formation KIA. And at the end of September this question was already discussed in Moscow at session of a national commission on delimitation Turkestan.

Thus, October 27, 1924 on II sessions CEC USSR organized the Karakalpak independent area in structure Kazakh ASSR. In its structure Karakalpakstan was up to middle of 1930.

The way from reunification of Karakalpakstan and formation KIA in 1924 in structure of the Kazakh independent republic before reception of a political autonomy should be long even that Kazakhstan, as was told above, at this time was a political autonomy in structure of Russia. However entry of Karakalpakstan from middle of 1930 is direct in structure of Russia has sped up process of transformation of Karakalpakstan of independent area in independent republic. By one of occasions, which has served in business of connection of Karakalpakstan to Russia and after transformation it in a political autonomy, in our opinion those political processes which serve occurred in 1929-1930 years in Karakalpakstan. That is national revolts and meetings directed against the Soviet authority. Thus, the

independent area was transformed into independent republic, that is has received a political autonomy.

These facts are only description of the external party of development of this complicated process. As it is known, the history always is "made" by the people, and the political transformations, which were in Karakalpakstan, were not exception - internal "engines" of all these processes there were concrete persons - unigrants from Karakalpakstan.

In March, 1932 at REC KIA the organizational commission "was formed on transformation of the Karakalpak independent area to independent republic" [3], which chairman was nominated by K.Nurmukhamedov. In the commission were: the assistant D.Loginov, secretary Doschanov, and also K.Avezov, D.Djanaliev, Chernikov and Sergeev.

At session of this commission, which held on that day, the agenda of forthcoming republican Constituent congress was considered. As we see, this commission developed organizational questions of transformation of Karakalpakstan, realization of congress, session etc. Also by decision of the given commission of March 5 that of year was called extraordinary IV plenum REC KIA, on which was decided to petition before Presidium CEC RSFSR for transformation of Karakalpakstan to independent republic (further KKASSR).

In turn Karakalpak RC CP(b) on a line of a party directs in CC CPT(b) the report with the request to support the decisions of the Karakalpak government.

The answer to the petition of the Karakalpak management was accepted by Presidium CEC RSFSR of the decision from March 29, 1932, where was spoken: "1. Karakalpaks independent area according to wish willy of its labor people to transform in existing borders in KKASSR.

2. By the supreme body of authority in territory KKASSR, down to convocation of its republican congress of councils to consider Karakalpak REC, which to charge with convocation of the first Karakalpak republican congress of councils for election CEC and organization of the device of authority" [4].

By the same decision it was entrusted to a department of Nationalities at Presidium CEC RSFSR to prepare "the Project of a rule about the state device KKASSR".

May 11, 1932 in Moscow behind the signatures of the chairman CEC RSFSR M.Kalinin and vice-president SPC RSFSR T.R.Rskulov was accepted The decision "About the statement of a rule about the state device KKACCP" [5].

In connection with transformation of Karakalpakstan to independent republic Karakalpak RS CP(b) and REC KIA have let out the reference to the worker of Karakalpakstan, in which the huge





historical meaning of formation KKASSR for the further development of economy and culture of republic, for blossoming national state of the Karakalpak people was emphasized. According to it REC KIA has accepted the decision from March 28, 1932, on the basis of which the preparation for Constituent congress of councils KKASSR was widely developed.

May 25, 1932 in Turtkul (in that time was capital of Karakalpakstan) in solemn conditions has opened I Constituent congresses of councils KKASSR. May 29 the congress has finished the work and finally has ratified transformation of Karakalpakstan to independent republic.

Thus, on the basis of the revealed new archival documents, it is possible to reach a conclusion that the level of economic, political and cultural development of our territory has enabled to receive a political autonomy. It is necessary also to remember those who stood at sources of reception of this autonomy, outstanding state figures of Karakalpakstan. The influence them on all these processes connected to transformations, is very great. But, unfortunately, the reprisals of the 30-th years have destroyed many from them.

## CONCLUSION

So, Karakalpak state of the Soviet type, which was created for the first time in 1922, in 1924 join uniform administrative independent in structure of Kazakhstan. With 1930 on 1936 гг. Karakalpakstan was in structure of Russia and in 1932 was transformed into a political autonomy. And from the end 1936 till the present time Karakalpakstan is in structure of Uzbekistan, and in December, 1990 it gets the sovereignty in structure of Uzbekistan. For all period of existence of the Soviet state type the set of historical events was Karakalpak which require separate research works. We here wanted to result only those materials, which show, what stages the Karakalpak people has passed during existence of the Soviet type state.

## REFERENCES

1. *Nazarov S. From the history of the Sredazburo of the Central Committee of the RCP(b). (1922-1924) Tashkent, 1965., Allaniyazov B. Revolution mobilized. Nukus, 1991.*
2. *Rosenstein L. K. On the issue of education of the KKASSR. Nukus, 1957., Tatybaev S. To the history of converting KCAL to ASSR. Nukus, 1959., Kamalov S., Kalniyazov U. The great October revolution and the creation of the Karakalpak state. Nukus, 1987., Kulumbetov T. Development of Soviet statehood of the Karakalpak people. Nukus, 1966., Ahundzhanov D. The Establishment and development of socialist statehood in the Soviet Karakalpakstan. Nukus, 1984., etc.*
3. *Central state archive of the Republic of Karakalpakstan - Fund 229, list 1, case 67, page 15.*
4. *Central state archive of the Republic of Karakalpakstan - Fund 229, list 1, case 67, page 27.*
5. *Central state archive of the Republic of Karakalpakstan - Fund 229, list 1, case 67, page 1-2.*





# CURRENT STATE OF STUDY AND USE OF MATERIALS OF THE ORENBURG EXPEDITION IN HISTORIOGRAPHY

**Saparniyazov A.**

*Junior researcher of the department History, Karakalpak research Institute of Humanities, Karakalpak branch of the Academy of Sciences Republic of Uzbekistan , Nukus, Uzbekistan.*

Article DOI: <https://doi.org/10.36713/epra4777>

## ABSTRACT

*The purpose of the research is to analyze the works of researchers on the problem of socio-economic and political history of the Karakalpaks, their relations with Russia in the XVIII century, written mainly on the basis of documents of the Orenburg expedition. The nature and main directions of studying the issue under consideration are defined. The available literature is shown, which is diverse in genre and level of theoretical generalization, as well as in the range of issues raised in them. Scientific novelty consists in a critical consideration of the issue with the involvement of the works of modern scientific historians. As a result, it is found that not all aspects of the history of the Orenburg expedition in the study of the Karakalpaks of the XVIII century are fully developed today. In this regard, the need to continue the in-depth study and development of issues related to the history of the Karakalpaks of the XVIII century is justified.*

**KEYWORDS:** *Russian Empire, Central Asia, karakalpaks of the XVIII century, materials of the Orenburg expedition, traveler's reports, Russian archives, historiographical research.*

## I. INTRODUCTION

The materials of the Orenburg expedition of 1734-1744 contain the earliest Russian-language information about the Karakalpaks, so any historical and ethnological research, one way or another, begins with this source. We think that on the basis of valuable information extracted from the documents of the Orenburg expedition, it is possible to recreate a more complete picture of the life of the Karakalpak people of the XVIII century.

The study of the history of the Karakalpaks of the XVIII century based on the documents of the Orenburg expedition contains considerable difficulties. Writing the socio-economic and political events of the period under study is allowed to be relatively easy work, since they are reflected in the documents of the Orenburg expedition. However, understanding them without specifying the main reasons for these events is not an easy task. And we believe that the reconstruction of the socio-economic

and political history of the Karakalpaks of the XVIII century is still far from being completed.

The degree of study of the materials of the Orenburg expedition is varied. Some of them were discovered long ago and studied well enough, they were widely used in scientific research, and others are still being introduced into scientific circulation.

Since the beginning of the 90s of the XX century, new, significantly expanded and revised publications have appeared in our country, which summarize the results of many historical studies, including on the problem that interests us. These works contain a lot of interesting material that contributes to the correct, that is, unbiased and objective coverage of our chosen topic.

## II. LITERATURE REVIEW

In 1993, Professor M. Tileumuratov wrote the work "Historical cultural relations of the Karakalpaks with Russia and Bashkiria in the XVIII-early XX centuries" [7]. The task assigned to the



author of this study was to summarize the results of specific research on the history of culture of Karakalpakstan, to study the Karakalpak culture in interaction with the Russian and Bashkir peoples in the XVIII-XIX centuries. When writing this book, he was particularly interested in the works of such participants of the Orenburg expedition as V. Tatishchev, I. Kirilov, P. Rychkov and other Russian researchers.

### III. DISCUSSION

Among the Karakalpak researchers of this period, we can note O. Yusupov, whose activity was associated with the study of the history of the Karakalpaks based on the materials of the Orenburg expedition. Among his works of great interest is "Janibek Batyr, Maman Batyr, Murad Sheikh, Aziz Baba, Korazbek Biy-atalyk, Khojamurat Biy and Toremurat Biy Sufis or sources from the past "Maily shengel" [10] (this book is written in the Karakalpak language). In this work, based on rich archival materials, many aspects of the history of the Karakalpaks and aralans who lived in the Aral sea, the Syr Darya and the lower reaches of the Amu Darya are analyzed. Events related to the trips of the first and last Karakalpak ambassadors Janibek Batyr and Maman Batyr to Moscow and St. Petersburg are covered. Data are available about the relationship of the ruler Aral possession of Karateka and Russian General I.Tevkelev.

In 1995, a dissertation was written by and.Piskunova on the topic "Syrdarya Karakalpaks and Russia in the XVIII century" [5]. This work is devoted to the study of problems, trends, and features of relations between the Syrdarya Karakalpaks and the peoples of the Russian Empire in the XVIII century. In the relevant parts of this dissertation, we used some information from the materials of the Orenburg expedition, which served as one of the source bases of the research.

The work of academician S. Kamalov "From the history of the formation of the Karakalpak people and its statehood" [4] (this book is written in the Karakalpak language) is still the most relevant today. In this small volume of work, S. Kamalov, using some data from the materials of the Orenburg expedition, was able to reveal in a popular form questions about the origins and stages of the formation of the Karakalpak state over many centuries.

Questions of the Aral-Kungrad domain are considered in the work of G. Khozhaniyazov [8]. In it, the author tried to carry out a fairly detailed analysis of the history of the Aral domain, highlighting the geographical, socio-political and demographic situation of this state Association.

In 2018, scientific historians of the Karakalpak research Institute of Humanities of the

Karakalpak branch of the Academy of Sciences of the Republic of Uzbekistan G. Khozhaniyazov and A. Dzhumashev published a scientific article entitled "the Ethnic composition of the Aral-Kungrad domain in the XVII-XIX centuries: a forgotten page of history" [9]. The reviewed article was directly devoted to the history of the Aral domain. The authors skilfully presented the content of the work on the basis of Eastern (Abulgazi, Munis, Agakhi) and Russian information (D. Gladyshev, I. Muravin, P. Rychkov). The structure of this article allows the reader to gain a systematic understanding of the history of the population, territories, as well as toponymic names, which explains in detail the etymological origin of the name of the Aral sea.

Among the Uzbek historians, the question we are studying was touched upon by H.Gulomov [1]. In his monographic work, he considered the patterns and directions of development of interstate relations between the Central Asian khanates and Russia in the XVIII - first half of the XIX century, paying special attention to the roles of diplomatic missions in Bukhara, Khiva, Tashkent and Kokand.

From the above brief review, it can be seen that Karakalpak and Uzbek historians during the period of independence, the history of the Karakalpaks of the XVIII century was covered in the context of the Orenburg expedition. However, this historiographical analysis of scientific works allows us to conclude that the history of the Karakalpaks has not yet been fully studied on the basis of the documents of the Orenburg expedition and the military advance of Russia into the territory of the Karakalpaks of the XVIII century, which makes it possible to speak about the incomplete development of this problem. In addition, many of the materials available in various archives and libraries have not yet been fully introduced into scientific circulation and subjected to analysis and scientific generalization.

Some of the issues of our topic may be covered as a result of research of works and collections on the history of other peoples of Central Asia and Kazakhstan, who, like the Karakalpaks, experienced colonial oppression from the Russian tsardom. This is mainly the research of Kazakh historians, which highlights the situation of the peoples before and after the conquest of Central Asia and Kazakhstan by Russia.

The Asian region has always attracted the attention of Europeans. In the XVIII century, Central Asia was visited by many Western travelers, diplomats, traders and missionaries, who captured what they saw in their memoirs, travel notes and diaries. As a variety of information about the region accumulated, the cognitive interest in it grew. All this is described in a fascinating way In K.



Esmagambetov's book "What was written about us in the West" [3].

I. Erofeeva's monograph "Khan Abulkhair: commander, ruler and politician" [2] is devoted to the political biography of the military and statesman of the Kazakh people of the XVIII century – Khan Abulkhair. It examines the history of the Orenburg expedition on the basis of its own documents, along with some historical information about the Karakalpaks, as well as their role in the socio-political life of the peoples of Central Asia in the XVIII century.

The collective work "the Past of Kazakhstan in sources and materials" [6] provides large auxiliary materials for our research. This source is selected and systematized by chronological and thematic features excerpts from documents of travelers and diplomats of the XVIII century. The materials contained in these collections, along with the history of the Kazakhs, reflect the life, relationships of the Karakalpaks with neighboring States and peoples, as well as the history of the first decades of Russian colonial expansion to the East. These works include excerpts from the works of participants of the Orenburg expedition, which expose the predatory policy of tsarist Russia.

#### IV. CONCLUSION

Thus, assessing the degree of study of the topic, we can state that a huge layer of historical material has been accumulated, which allows us to expand the range of scientific interests. However, the history of the Karakalpaks in the materials of the Orenburg expedition is not sufficiently studied. In addition, many documents of the Orenburg expedition have not yet been fully introduced into scientific circulation and analyzed.

#### V. REFERENCES

1. Gulomov H. *Diplomatic relations of the States of Central Asia with Russia in the XVIII-first half of the XIX century*. Tashkent: Fan, 2005.
2. Erofeeva I. *Khan Abulkhair: commander, ruler and politician*. Almaty: Sanat, 1999.
3. K. Esmagambetov. *What was written about us in the West*. Alma-Ata: Kazak Universiteti, 1992.
4. Kamalov S. *From the history of the formation of the Karakalpak people and its statehood*. Nukis: Ilim, 2001.
5. Piskunova I. *Syrdarya Karakalpaks and Russia in the XVIII century. ... candidate of historical Sciences*. Nukus: Institute of history, archeology and Ethnography of the Karakalpak branch of the Academy of Sciences of Uzbekistan, 1995.
6. *The past of Kazakhstan in sources and materials / Under the editorship of Prof. Asfendiyarova S. D. and prof. Kunte P. A. 2nd ed. Sat. 1: (V century BC – XVII century ad)*. Almaty: Kazakhstan, 1997; *the Past of Kazakhstan in sources and materials / Under the editorship of Prof. Asfendiyarova S. D. 2nd ed. Sat. 2*. Almaty: Kazakhstan, 1998.
7. Tileumuratov M. *Historical and cultural ties of the Karakalpaks with Russia and Bashkiria in the XVIII-early XX centuries*. Nukus: Bilim, 1993.
8. Khozhaniyazov *City of Aral-Kungrad possession // Bulletin of the CMT Academy of Sciences of Uzbekistan*. Nukus: 2004, no. 7. - SS. 52-55.
9. Khozhaniyazov G., Dzhumashev A. *Ethnic composition of the Aral-Kungrad domain in the XVII-XIX centuries: a forgotten page of history // Oases of the silk road: modern problems of Ethnography, history and source studies of the peoples of Central Asia: to The 100th anniversary of doctor of historical Sciences Balkis Khalilovna Karmysheva, 2018: collection of scientific articles / ed. Kotyukova T. V. Moscow: 2018. - SS. 131-141.*
10. Yusupov O. *Dzhanibek Batyr, Maman Batyr, Murad Sheikh, Aziz Baba, Korazbek Biy-atalyk, Khojamurat Biy and Toremurat Biy Sufis or sources from the past "Maila shengel"*. Nukis: Karakalpakstan, 1993.



# SEMANTICS AND STRUCTURE OF COMPLEX WORD COMBINATIONS IN THE CONTEMPORARY KARAKALPAK LANGUAGE

**Opaeva Raygul Aymanovna**

*A lecturer for the Department of Karakalpak linguistics at Nukus State Teachers' Training Institute after Ajiniyaz*

Article DOI: <https://doi.org/10.36713/epra4733>

## ABSTRACT

*The article deals with semantics and structure of complex and composite words appearing nowadays in the modern Karakalpak language.*

*Complex words are formed from two or more words and denote a broad concept. Combination of their components are combined by meaning as fixed combinations and they perform a function of one member of a sentence.*

**KEY WORDS:** *Composite terms, thematic classification, lexical-semantic classification, structure, paired words, abbreviated words, borrowed composite words, tracing.*

## DISCUSSION

Complex words, unlike phrases, act as whole-formed units and it is impossible to insert another word between its components.

In the modern Karakalpak language formation of complex words in the recent decade has become a very productive way of word formation. If we consider them from a semantic point of view, they encompass words that enter various spheres of the life. Especially actively complex words are used in journalistic and scientific styles.

Complex words of the Karakalpak language have hardly been studied so far. Phraseological, syntactically indecomposable combinations have also not been studied. Some studies related to this aspect are fragmented. In this connection, our chosen subject of investigation remains topical to this day.

The novelty of the work lies in the fact that for the first time an attempt is made to study complex words and phrases in structural, thematic and lexical-semantic aspects.

The practical significance of the work is determined by the fact that its results can be used in the development of lectures and seminars, as well as in the compilation of dictionaries.

Based on the empirical collected data modern complex words of the modern Karakalpak language were divided from a semantic point into the following types:

I. Composite terms related to the socio-economic sphere of life *бәнтликке көмеклесу орайы (center for employment), бес күнлик жумыс хәптеси (five-day working week), банк аудити (bank audit), банк филиалы (Bank branch), банк есапбети (account Bank), биржа товары (commodity exchange), киши бизнес (smaller business), экономикалық реформа (economic reform), турак жай фонды (housing fund), төлеу терминаллары (payment terminals), еркин базар (free market), киши кәрхана (smaller enterprise), қоспа кәрхана (joint venture), ири оңлау жумыслары (work on capital construction), пластик карточка (plastic card), исбилерменлик субъектлери (entrepreneurial entity), хожалық жүритиуши субъект (economic entity), аксил реклама (axial advertising), etc. For example, *Хәзирги уақытта исбилерменлик субъектлери тәрәпинен пластик карточкалар хәм төлеу терминалларынан пайдаланыу хәм де**





тутыныушыларға усы төлем түри арқалы хызмет көрсетуі кеңнен өзлестірилмекте - *At present entrepreneurial entities actively practice such new payment technologies in their work with customers as plastic cards and payment terminals (Erkin Qaraqalpaqstan, 10.09.2009).*

By the structure the complex words are divided into the following types:

1. **Noun + noun:** мийнет биржасы (*labor exchange*), банк филиалы (*bank branch*), банк аудити (*bank audit*), пластик карточка (*plastic card dot*), etc.

2. **Adjective + noun:** киши кәрхана (*smaller enterprise*), қоспа кәрхана (*joint venture*), киши бизнес (*smaller business*), еркин базар (*free market*), etc.

3. **Action noun + noun:** төлеу терминаллары (*payment terminals*), etc.

4. **Noun + action noun + noun:** бәнтликке көмеклесуі орайы (*employment assistance center*), хожалық жүритуіши субъект (*economic entity*), etc.

5. **Adjective + action noun + noun:** ири оңлау жұмыслары (*work on capital construction*), etc.

6. **Numeral+action noun + noun:** бес күнлик жұмыс хәптесуі (*five-day working week*), etc.

II. Composite terms formed in connection with changes in the field of medicine: репродуктив саламаттылық (*reproductive health*), Республикалық көп тармақлы медициналық орай (*Republican diversified medical center*), бас шыпакер (*head physician*), қыстаулы медициналық жәрдем (*emergency medicine*), орта буын медицина хызметкерлері (*mid-level medical personnel*) стационар емлеу (*inpatient treatment*), etc. For example: Оларда профилактикалық көріктен өтип раққа қарсы гүресуі жұмыслары күшли алып барылады, халқы өзлерине, ден-саулығына айрықша итибар менен қарайды. – *Their patients undergo prophylactic examination, they carry out intensive work to fight against cancer, their patients pay a big attention to themselves and their health (Qaraqalpaqstan. № 5-6).*

These complex words by their morphological structure are divided into the following types: **adjective+noun:** профилактикалық көрік (*preventive examination*), стационар емлеу (*inpatient treatment*), etc. **noun + noun:** бас шыпакер (*chief physician*), and so on; **adverb+noun:** тез жәрдем (*ambulance*), etc.

III. Composite terms formed due to changes in the judicial-legal sphere: адам саудасы (*human trafficking*), нәшебентлик затлар (*narcotic staff*), реакцион-диний топтарлар (*reactionary religious groups*), адвокатлар фирмасы (*advocacy office*), адвокат этикасы (*lawyer's ethics*), бажыхана транзити (*customs transit*), газли қураллар (*gas weapons*), хаяллар жынаятшылығы (*female crime*), криминалистлик техника (*forensic technology*), улыўма мүлк (*common property*), бир адамлық камера (*single cell*), etc. For example, Адам саудасы — инсан қәдир-қымбатына қәуип салатуғын трансмиллий, уйымласқан жынаятшылық көринислериниң бири есапланады - *Human trafficking is considered one of the types of transnational organized crime threatening honor and dignity of the whole mankind (Gárezsizlik hám nızam, 27.02.2010).*

Consideration of their structure reveals the following types:

1. **Noun+noun:** адам саудасы (*human trafficking*), адвокат этикасы (*lawyer's ethics*), адвокатлар фирмасы (*advocacy office*), etc.

2. **Adjective + noun:** газли қураллар (*gas weapons*), нәшебентлик затлар (*narcotic staff*), etc.

3. **Pronoun+noun:** улыўма мүлк (*common property*), etc.

4. **Numeral + noun:** бир адамлық камера (*single cell*), etc.

IV. Composite terms formed due to development of mass media: цифралы телевидение (*digital television*), медиа базар (*media market*), интернет материаллары (*Internet materials*), мәлимлеме - ресурс орайы (*information-resource center*), газета тиражы (*newspaper circulation*), журналистлик интуиция (*journalistic intuition*), ғалаба хабар қураллары (*mass media*), цифралы тюнер (*digital tuner*), etc.

If we consider these examples by the morphological structure, the complex will have the following types:

1. **Noun + noun:** газета тиражы (*newspaper circulation*), мәлимлеме- ресурс орайы (*information-resource center*), etc.

2. **Adjective + noun:** цифралы телевидение (*digital TV*), журналистлик интуиция (*journalistic intuition*), etc.

3. **Pronoun + noun:** ғалаба хабар қураллары (*mass media*), etc.

V. Composite terms formed due to changes in the field of communication: уялы телефон (*cell*



*phone*), *факсимиллик байланыс (facsimile communication)*, *байланыс операторы (telecom operator)*, *мобиль телефон (mobile phone)*, *почта жөнөлтпелери (postal transfers)*, *пул жөнөлтпелери (money transfers)*, *исеним телефоны (helpline)*, *кең полосалы сымсыз байланыс (broadband wireless)*, *сим карта (sim card)*, etc. For example, *Электр байланысының тийкарғы түрлери: телефон, телеграф, факсимиллик байланыс, мағлыұматларды жеткерип беріу, видеотелефон байланыслары болып табылады.* - The main types of electrical communications are telephone, telegraph, facsimile, information delivery and video telephony (*Erkin Qaraqalpaqstan, 23.03.1995*).

VI. Compound terms formed due to changes in the field of education: *мәмлекетлик грант (state grant)*, *тест сынақлары (testing forms)*, *мәмлекетлик тест орайы (state test center)*, *магистратура бөлүми (magistracy department)*, *магистр дәрежеси (master's degree)*, *титул қағазы (title page)*, *қосымша контракт (alternative contract)*, *жуўмақлаушы қадағалау (final assessment)*, *технологиялық карта (technological map)*, etc. For example: *Өзбекстан Республикасы Қаржы министрлиги, 2010 / 2011-оқу жылында мәмлекетлик грантлар тийкарында бакалаврият, магистратураға қабыл етиудің тастыйықланған квоталарына муўапық қәлиплесип атырған студентлер контингентин есапқа ала отырып, бюджеттен зәрүрли қаржылар ажыратылыуын тәмийинлесин.* - *The Ministry of Finance of the Republic of Uzbekistan in the academic year of 2010–2011 in accordance with the approved quota for admission to a master and bachelor level study on the basis of a state grant, taking into account the formed student contingent will ensure the allocation of necessary funds from the budget (Qaraqalpaqstan jasları, 3.06.2010).*

The structure of the composite terms formed due to changes in the field of education is as follows:

1. **Noun + noun:** *мәмлекетлик тест орайы (state testing center)*, *тест сынақлары (testing forms)*, *магистр дәрежеси (master's degree)*, *титул қағазы (title page)*, etc.

2. **Noun + action noun:** *халық билимлендириу бөлүми (Department of Public Education)*, etc.

3. **Adjective+action noun:** *жуўмақлаушы қадағалау (final assessment)*, etc...

One of the most popular types of composite words is paired words. They indicate a certain degree of transformation of ordinary words into a

composites being used in pairs. About paired words which are one of the types of composite words, E. I. Ubryatova [3, p. 301] in her work “Paired Words in the Yakut Language” indicates different types of paired words and determines their basic originality.

1. The author points out that in the Turkic languages there are two ways of pairing words: the way of pairing and the way of matching. In both cases, the grammatical indicators of change and formation of the word belong to the last (second) component of paired words. The first method is characteristic of all the Turkic languages, and the second method is characteristic of the Old Turkic languages. For example: In the Yakut language *уйе-ара (parents)*, *уйем-арам (my parents)*.

N. A. Baskakov [1, p. 2, 17] in his work “The Karakalpak language” considers complex nouns as paired words, i.e. words that consist of two elements forming pairs reinforce the meaning or indicate collectivity, generalization. For example,

1. **Words denoting collectivity:** *төбө-төбө—таулар (high-high mountains)*, *ойын-ойын—ойыншықлар (funny-funny toys)*.

2. **Words denoting generality:** *ер-дьюген (saddle-bridle)*, *юстки-басы (clothing)*, etc.

Paired word of the Karakalpak language are widely regarded in a special study and in some articles of A. Najimov [2, p. 32, 3-29; 63, 122-128].

In a recent time paired words due to changes in the society and development of science and technology have been widely used in press. For example, *жанылғы энергетика (fuel energy)*, *төлем-контракт (pay-contract)*, *сауда-экономикасы (trade economy)*, *илимий-әмелий (scientific and practical)*, *илимий-изертлеу (scientific research)*, *семинар-кеңес (training seminar)*, *арақ-шарап (vodka and wine goods)*, *суд-хуқық (court and law)*, *сауда-санаат (trade and industry)*, *мәлимлеме-таллау (analytical and identifying)*, *ауыллық-шыпакерлик пункт (rural medical center)*, *нефть-газ (oil and gas)*, *санитария-эпидемиология (sanitation-epidemiology)*, etc. For example, *На научно-практической конференции участвовал Председатель Верховного Совета Республики Каракалпакстан Б. Нурабуллаев.* - *The scientific and practical conference went off in association of the Chairman of the Supreme Council of the Republic of Karakalpakstan B. Nurabullaev (Erkin Qaraqalpaqstan, 4.12.2010).*

The most productive complex words are abbreviated words. Expansion of public services has a certain impact on language development.

Abbreviated complex words are formed from two or more abbreviated words. The process of





abbreviation is characteristic of nouns only. Therefore, complex words are the main source in their formation. For example, *ЎзР* (*the Republic of Uzbekistan*), *ЎзА* (*Agency of Uzbekistan*), *ЎзХДП* (*People's Democratic Party of Uzbekistan*), etc.

In the Karakalpak language abbreviated words were adopted primarily in the Russian version: *RSFSR*, *sovnarkom*, *revkom*, *GPU*, etc. Afterwards some words were adopted in the form of tracing. In the Karakalpak language tracing of abbreviated complex words has become a productive phenomenon since 1960.

Abbreviated complex words that are in current use are different by structure and way of formation. Basically they are divided into three groups:

1. Abbreviated complex words borrowed from other languages without changing the structure. Such the words in the Karakalpak language cannot be divided into component parts since they will not correspond to the initial accepted form. For example : *UNESCO*, *FIDE*, etc.

2. Abbreviated complex words formed by way of tracing some borrowed words. Such print tracing is somewhat productive formation. For example: *ООН* (*UN*), *SShA* (*USA*). etc.

3. Abbreviated complex words formed from original Karakalpak words. There are very few words of such sort in the language and they are extremely unproductive. For example, *ХББ* (public education department), *БКО* (employment assistance center), *ЖШЖ* (*limited liability company*), etc.

Thus, in conclusion we need to point out hereby that in general complex words of the Karakalpak language have recently begun to develop productively in connection with development of the society, science and technology.

## REFERENCES

1. Baskakov N.A. *The Karakalpak Language. II volume. Phonetics and morphology (Parts and word formation)*. Moscow, 1952.
2. Najimov A.N. *Methods of forming paired and paired-repeated words in the Karakalpak language. Abstract of Cand. Diss. Nukus, 1971.*
3. Ubryatova E. *And Paired words in the Yakut language. M.-L., 1948.*



## **HISTORY OF FOREIGN LANGUAGE EDUCATION IN KARAKALPAK SCHOOL**

**Bekjanova Ainura Markhabaevna**

*Senior teacher at the department of social and humanitarian disciplines of the Nukus branch of the Institute of arts and culture of Uzbekistan*

Article DOI: <https://doi.org/10.36713/epra4765>

### **ABSTRACT**

*This article considers the history of teaching foreign languages in the conditions of Karakalpakstan, chronologically covering the period from the end of the XIX to the end of the XX centuries. Teaching arabic, then opening Russian-native schools and introducing the Russian language into the program, forming a new education system and teaching German, English and French in schools in Karakalpakstan - here is a list of issues that are addressed in this material. The author tries to carry out a comparative analysis of methods of teaching foreign languages of the pre-Soviet and Soviet periods. This issue is actualized by the fact that during the period when Uzbekistan achieved national independence, this issue has become an urgent task of the educational process.*

**KEY WORDS:** *education system, mektebs, general education schools, Russian language, foreign languages, methods of teaching.*

### **INTRODUCTION**

In the age of globalization, when geographical boundaries are erased, horizontal relations are increasingly strengthened, cooperation among states, communities and ordinary people is developing, and the world is becoming the most important factor for progress. At the same time, progress is a joint activity, an opportunity to agree and come to a consensus and thus achieve mutual enrichment of cultures and prosperity for all. This can be achieved only by a person who has not only high educational potential, but also has skills in practical communication with representatives of other linguistic cultures.

### **ANALYSIS**

This is achieved directly through the system of education and training in foreign languages. In accordance with the decision of state bodies

throughout Uzbekistan, including Karakalpakstan, a new system of teaching foreign language has been phased in. The main emphasis were placed on the in-depth and ubiquitous study of English [1]. Nowadays, English is widely spoken in the world, wider than French, German, Spanish, Russian and Arabic, used as means of international communication. In many states, it was used as a native, second and foreign language, for example,

Arabic, used as means of international communication. In many states, it was used as a native, second and foreign language, for example, English occupied a special place in seventy countries of the world, in nineteen countries it was a state language. In most countries, he is taught at school as the main foreign language, crowding out other foreign languages. In Karakalpakstan, the subject of English was not the first foreign language in the education system. The English language began to be



taught in our country from the second half of the twentieth century, although the Soviet state paid great attention to the issue of teaching foreign languages and the pre-war period. The existing education system of the pre-revolutionary period included teaching arabic graphics, on the basis of which the Karakalpak literary language was formed. In fact, it was a foreign language, learning went on the basis of simply learning the suras of the Kuran and explaining their meaning. With the accession of part of the territory of modern Karakalpakstan to Russia, they began to open Russian-native schools, which became the basis for the dissemination of Russian language education [2, p. 23-24]. The Russian language began to be taught in jadid schools. During the active struggle for the eradication of illiteracy in the 1930s, the Russian language began to be considered as a language of international communication, there was an active process of training personnel and textbooks for national outskirts. The pre-war period, English, German and French were not paid attention to, since they were not included in the curriculum of the Karakalpak school. Only the post-war period began the process of training foreign language teachers and teaching foreign languages. This issue still remains unexplored, especially since the question of techniques for teaching foreign languages, its methodology, remains out of the field of view of researchers. In our opinion, it was not in demand during the Soviet rule, and the increase in scientific interest in the topic during the period of independence is actualized, first of all, by the urgent need for social development.

## METHODS

The history of teaching foreign languages in the territory of Karakalpakstan dates back more than a century, which were associated with political and economic processes. The first mektebs on the territory of Karakalpakstan were foreign-speaking. Researcher M. Karlibaev writes that "the emergence of mektebs as a muslim school of primary education dates back to the VIII century, when the arab conquerors began to spread their religion - Islam, and with it writing" [3, p. 5].

The famous scientist J. Urumbaev also pointed out that "the training in mektebs was purely religious and scholastic in nature and was reduced to mechanically memorizing the texts of the Qur'an and prayers in Arabic" [4, p. 39]. Such mektebs did not exist either curricula or curricula, there was a simple memorization of arabic words [2, p. 14]. Similar muslim schools existed in Karakalpakstan until the 1930s. Foreign language education in schools in Karakalpakstan continued due to the opening in 1874

a Russian elementary school in the Amudarya department, or rather in Petro-Alexandrovsk. Then, on its basis, the Petro-Alexander City School was opened, in which instruction was conducted in Russian [4, p. 54]. A completely different stage in the history of the practice of teaching foreign languages falls during the years of Soviet power. However, the Russian language for the party-Soviet apparatus was not considered foreign, although it was for the local population. In this perspective, this question has not been studied in historiography. At the same time, a new education system is being formed, German, then English and French, were gradually introduced into the school curriculum as an educational subject. However, in schools in Karakalpakstan, unlike other regions, in addition to Russian, other foreign languages are not studied. From the historiography of the question, it can be noted that the problem of the Soviet system of teaching foreign languages were the lack of practical communication skills, with the exception of the Russian language. At the same time, the teaching methods were the same: translation, grammar-translation, mixed and natural (direct). The general disadvantage in the teaching process in the conditions of schools in Karakalpakstan is the emphasis in teaching on speech, teaching general cultural knowledge without taking into account local characteristics and the national language. It is worth noting that in the schools of the republic, a mono-cultural approach in teaching foreign languages still prevails.

## RESULTS AND DISCUSSION

As you know, the basis for the formation of the written language of local nationalities were arabic graphics, it was also taught in local schools (mektebs). The training was mainly limited to learning the texts of religious books, which was carried out by adding arabic letters. This approach is more reminiscent of the natural method, which was fixed in the works of M. Berlitz and F. Guen, as well as representatives of the direct method of learning - straightforward (G. Suit, G. Palmer, etc.).

In this case, they pointed out that in the process of applying this method, a practical goal is set - to teach students to speak a foreign language, when the student follows the heard, imitating the oral speech pattern, that is, imitation and learning [5]. Teaching foreign languages, in particular, the Russian language, especially began to develop rapidly from the end of the 19th century, when there was a need for a large number of people who speak Russian [6]. At the initiative of the tsarist administration, the first 4 schools were opened in the Amu Darya department - the city school in Petro-Aleksandrovsk [7], women's parish school, and then



at the beginning of the twentieth century two Russian-native schools were opened in Chimbai and Shorakhan [2, p. 23]. Judging by some literary materials, in the process of teaching the Russian language in the Russian-native schools of Karakalpakstan, a translation method was used (grammar-translation and vocabulary-translation), when the training is based on the study of grammar and vocabulary. At the beginning of the twentieth century, new-fashioned jadid schools began to open on the territory of Karakalpakstan, where they also taught Russian as foreign. For example, in the Shorakhan school, two hours were allocated daily to the Russian language. The foundations of the Kuran were also studied, elementary knowledge was given in arithmetic, history and geography. In the 1920s, teaching the Russian language as the main issue in the educational process was not, but its teaching took place from the first years of the establishment of Soviet power in Karakalpakstan. In the programs of the first Soviet schools and preparatory courses for teachers, the Russian language was one of the mandatory educational disciplines and was considered as the second after the native language.

In general, in the pre-war period, Russian was not considered as a foreign language in national schools, most likely, it was presented as a second native language. At the same time, teaching the Russian language wore another - political and ideological burden. "Russian language classes should help to educate an active fighter for communism," the document said. "Teaching the second language (in this case, Russian) contributes to international education" [8]. Meanwhile, the central part of the former USSR from the mid-1920s began to implement a new political and cultural campaign "Foreign languages - to the masses!".

The People's Commissariat of Education of the USSR made the teaching of foreign languages mandatory, streamlined the curriculum for foreign languages. A unified system of teaching foreign languages from school to university was developed. In the 1930s, the leadership of the USSR continued to work to strengthen the study of foreign languages. A unified system of teaching foreign languages from school to university was developed. In the 1930s, the leadership of the USSR continued to work to strengthen the study of foreign languages [9, p. 71-79]. On August 25, 1932, a decree of the Central Committee of the All-Union Communist Party of Bolsheviks "On curriculum and regime of primary and secondary schools" [10, p. 161-162] was issued, according to which the secondary school was supposed to provide at least one foreign language. Foreign languages recommended for teaching in high school, English, German and French were named.

Two years later, decisions were issued to strengthen the study of foreign languages in technical schools and universities [10, p. 416]. Mainly in the pre-war years, German was taught in about 70% of educational institutions, in the rest there were subjects of English and French. However, the widespread teaching of foreign languages in the periphery was difficult and in the pre-war period was never implemented. For example, in the conditions of Karakalpakstan, as we indicated above, foreign languages were not at all included in the training program. On September 16, 1940, the Council of People's Commissars of the USSR adopted a resolution "On the teaching of German, English and French", where it recognized the situation with the teaching of foreign languages in schools in the country as unsatisfactory. In this regard, the government proposed to take special measures, in particular, "oblige the People's Commissariat of the Union Republics to introduce the teaching of one foreign language (German, English, French) from grade 5 by 1943 in all secondary schools" [11]. In the post-war period, resolutions of the Council of Ministers of the USSR No. 3488 of October 4, 1947 were adopted, which noted that the study of foreign languages in schools were unsatisfactory. Classes with the study of foreign languages in schools, technical schools and universities gradually began to open, but the lack of personnel did not allow for full work in this direction. In secondary schools of Karakalpakstan until 1954, foreign languages were studied from the third grade, and then from the 5th grade, and there were no specialized schools with in-depth foreign languages. On May 27, 1961, the Council of Ministers of the USSR adopted a resolution "On improving the study of foreign languages", which noted that "the teaching of foreign languages in general education schools, in secondary special and higher educational institutions had improved somewhat. However, there are still serious shortcomings in this important matter. The vast majority of graduates of general secondary schools, special secondary schools and higher education institutions have knowledge of foreign language; a small margin of words and formal knowledge of grammar do not allow them to translate foreign text without a dictionary. Speaking skills are particularly inadequate. There are serious shortcomings in the training of foreign language teachers" [12]. Universities were instructed to expand training, textbooks, dictionaries, books, records, educational films were needed for schools [12]. According to the results of the 1961/1962 academic year, several dozen schools with the study of foreign languages were opened in Karakalpakstan [13]. In the 1970-1980s, the Russian language was taught



from the first grade, and foreign languages from the 5 grade. At the state level, measures were taken to expand quotas for the republic for the training of foreign language teachers, but the need for them remained high.

Meanwhile, in the 1980s, the methodological base for teaching foreign languages expanded. Methods based on the active work of thinking appear, on the development of a semantic guess, which was based on an audio-lingual skill technique. In the conditions of Karakalpakstan, this method did not have a wide opportunity, since schools lacked not only educational films and records, the technical devices themselves were rare. In teaching foreign languages (English, French, German) was based on a combination of comparative grammar-translation and natural approaches, which suggested explanations in the native language. In the 1970-1980s, single textbooks were compiled for all schools in the country without taking into account national language differences. They have a large number of translation exercises, the presence in the educational material of texts on the realities and facts of the central part of the country.

The general disadvantage in the teaching process in the conditions of schools in Karakalpakstan is the emphasis in teaching on speech, teaching general cultural knowledge without taking into account local characteristics and the national language. It is worth noting that in the schools of the republic, a monolingual and monocultural approach in teaching foreign languages still prevails.

## CONCLUSION

Today, it is already clear that with the transition to the information stage of the development of a society based on information technology and knowledge, education is becoming the most important resource for socio-economic and political development. The introduction of new didactic and methodological concepts, educational and methodological kits and other means of training, increase the level of instruction, including in foreign languages. To date, the range of methodological innovations had expanded significantly. The expansion of the horizons of communication links allow today to deepen intercultural relations and defined new prospects of educational and methodological tools for teaching foreign languages in the entire structure of educational institutions of Karakalpakstan. In general, this issue is very important in modern conditions, since the educational system is aimed not only at assimilating a certain amount of knowledge, but also at developing the student's personality, cognitive and creative abilities.

It is important for a modern school to form a holistic system of universal knowledge, skills as well as independent activity and personal responsibility, that key competencies determined the modern quality of education. We'll come to the conclusion that foreign languages are an unconditional element of the education of a cultural person, while foreign language has become a means of intercultural communication due to global changes in the political and economic life of our society.

## REFERENCES

1. Decree "On measures to further improve the system of teaching foreign languages" // Newspaper "People's Word". 2012.12.11. №. 240 (5630). The text see: <http://www.lex.uz>
2. Urumbaev J. About the work of education and briefly about the history of the school in the territory of Karakalpakia before the revolution. Nukus, 1964.
3. Karlibaev M. Madrasah in Karakalpakia of the XIX - early XX centuries. Nukus, 2002.
4. Urumbaev J. Essays on the history of schools in Karakalpakstan. Nukus, 1974.
5. Development of foreign language teaching methods abroad // <https://studwood.ru/548378/>
6. Essays on the history of public education and school in Karakalpakia: Nukus, 1958.
7. Petro-Aleksandrovsk was the administrative center of the Amudarya department of Turkestan Governor General. Then it was renamed the city of Turtkul and became the first capital of the Karakalpak Autonomous Region, now the administrative center of the Turtkul region of the Republic of Karakalpakstan. For more information, see: Nurzhanov S.U. Karakalpak Autonomous Region: history in sources. Nukus, 2014.
8. CSA RK, f.118, i.1, d.30, 9 p.
9. Shelestyuk E.V. Westernization in the USSR and Russia: analysis of some causes // Foreign language in the system of secondary and higher education: materials of the III rd International Scientific and Practical Conference on October 1-2, 2013. Prague, 2013. 216 p.
10. Public education in the USSR. Collection of documents. 1917-1973. M., 1974.
11. About teaching German, English and French. Resolution of the Council of People's Commissars of the USSR on September 16, 1940.// <http://istmat.info/node/18832>
12. On improving the study of foreign languages. Decree of the Council of Ministers of the USSR on May 27, 1961.// [http://libussr.ru/doc\\_ussr/usr\\_5690.htm](http://libussr.ru/doc_ussr/usr_5690.htm)
13. CSA RK, f. -188, i.4, d.450, 3-7 pp.





# A SURVEY OF THYROID DETECTION USING DATAMINING TECHNIQUES

**A.Vinitha**

Assistant Professor, Department of Computer Science,  
A.V.P College of Arts and Science,  
Tirupur, Tamilnadu, India.

## ABSTRACT

*The health is the major issue in today's world. Most of them are suffering from improper secretion of hormones. The improper hormone secretion arises due to lack of proper healthy food. Among the one is the thyroid deficiency. The thyroid problem occurs due to improper secretion of hormones in our body. The women are the most which are suffering from the thyroid problem. In this paper we will we will review some classification techniques which helps detect the thyroid problem.*

**KEYWORDS:** T3, T4 hormone, classification techniques

## 1. INTRODUCTION

The classification is the one of the data mining technique which helps to classify the data items according to the predefined class labels. For example if the bank is offering loan means the bank manager has to classify the customers according to the predefined class labels like low risk medium risk and high risk. The bank manager should know the risk of providing loan to the customers. There are different types of classification techniques are there. The thyroid gland is located at the neck. It exactly looks like butterfly. It helps to maintain the development and growth of the human body. It helps in metabolism process. The metabolism process is nothing but whatever we eat and drink is converted into energy by the hormones secreted by the thyroid gland. This is the main work of hormones of thyroid gland. If the hormones are not secreted properly the thyroid deficiency occurs and our intake food is not properly converted into energy.

## 2. LITERATURE SURVEY

The author states that (Umar Sidiq, 2019) thyroid deficiency occurs due to the deficiency of iodine. The author uses the Anaconda 3 5.2 which helps to find the accuracy in the classification algorithms. The author compared the k- nearest neighbour, support vector machine, naïve bayes, decision tree. The author compares the accuracy in above stated algorithms and tells the decision tree offers the high accuracy in detecting the thyroid problem. The accuracy is about 98.89 percentage. The

author concluded that the decision tree can be combined with any other algorithm to get higher accuracy. The author has downloaded the data set from one recognized lab from Kashmir.

The author (Bibi Amina Begum, 2019) compares different data mining techniques and compares the accuracy of the algorithm. Each algorithm gives different levels of accuracy. Hence any one classification algorithm can be used to detect the thyroid problem.

The author (Aswathi A K, 2018) states the earlier identification of thyroid disease will help to avoid the replacement of thyroid gland and severe health issues. The author uses the classification technique in that he used the support vector machine for classification. The naïve bayes is used to find the missing values in the data. After detecting the thyroid disease the author focused on giving some medical advice. The swarm optimization technique is also used to find the thyroid deficiency.

The author states (Ankita Tyagi, 2018) different types of classification algorithms like support vector machine, k nearest neighbour, decision trees are used to predict the thyroid deficiency. The author also uses machine learning algorithm called as artificial neural network which helps to find the thyroid problem. The author compared all the algorithms in finding the accuracy of detecting thyroid problem. The author finally suggested that the parameters used for detecting the thyroid problem should be minimized





because the patient should undergo more test and it also incurs more expenses and time consuming. The conclusion of the paper is to detect the thyroid problem with minimum parameters.

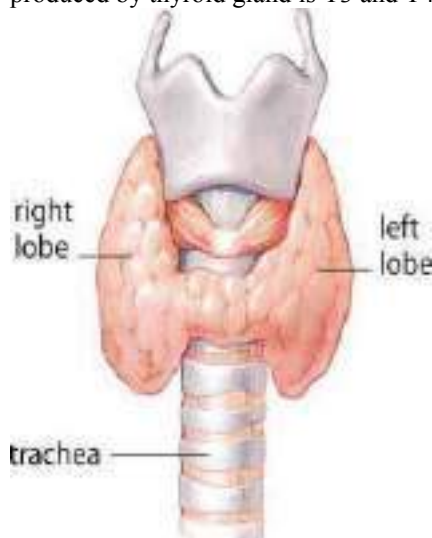
The author (Muhammad Anjum Qureshi, 2017) says that the thyroid disease can be predicted by using the online mode. The decision tree is used to predict the thyroid deficiency. Feature rejection, online ensemble, offline ensemble are the techniques used in detecting the thyroid problem. The accuracy of using decision tree is about 97.43 percentage. The feature ensemble helps to reduce the computational complexity.

The author (Qiao pan, 2016) tells that the thyroid deficiency is the major health issue in today's environment. The author uses the random forest to detect the thyroid problem. The accuracy of using random forest method is 95.63%.

The author (K.Sindhya, 2020) has stated that the predictive classification algorithm should take less time to predict the disease. The author compares with random forest, naïve bayes and J48 algorithm. Among these techniques the J48 produced the low time and highest accuracy at 99%.

### 3. RELATED WORK

There are different types of classification techniques which help to predict the thyroid problem. There are two types of disease in thyroid gland. They are hypothyroid and hyper thyroid. The hypothalamus and pituitary gland which creates the thyroid stimulating hormone which tells the thyroid gland to produce the more hormone if it is low. If the thyroid secretion is high then it will make the thyroid gland to produce fewer hormones. Thus thyroid gland should maintain the metabolism of the body. The hormone produced by thyroid gland is T3 and T4.



**Fig 1: Thyroid gland**

### 4. CLASSIFICATION TECHNIQUES

There are different techniques in classification. We shall discuss few techniques which helps to detect the thyroid problem.

#### Naïve Bayes

It is based on bayes theorem. The features of naïve bayes it should be independent of another. It is one of the classification algorithms. No pair of features is dependent on other (P Deepika, 2016).

#### Decision tree

It is one of the supervised learning techniques. It can solve both classification and regression problems. It uses tree representation to solve the problem of classification. The leaf node represents the class labels and internal nodes represent the attributes. The attributes are selected by using two measures called as information gain and Gini index. (K.Thenmozhi. P. M., 2014)

#### Artificial Neural networks

It is an information processing model. It exactly looks like human brain. It has many layers which help to give maximum accuracy. The neural network is the supervised learning technique. In supervised learning there will be one input and one output. The algorithm should learn by example. It mainly focuses on maximum accuracy. It helps to solve the classification and regression problems. The output of one node is connected with input of another node. Each node has weights which help to increase the accuracy.

#### Support Vector Machines

It is also a supervised learning technique. It represents the attributes as points in the hyper plane (Vinita, 2015). It helps to separate the data items by developing the hyper plane in to two items. The support vector machine can perform well both in linear and non-linear. In support vector machine we plot each point in the hyper plane and finally the plane that separates the two groups is identified. (P.Deepika S. D., 2019)

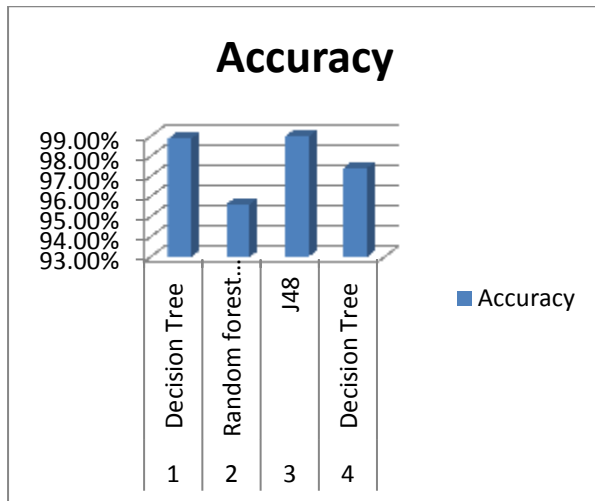
### 5. DISCUSSIONS

The different types of classification algorithms are used to predict the thyroid problem. Hence each algorithm generated different levels of accuracy.

S.No	Methodology	Accuracy
1	Decision Tree	98.89%
2	Random forest method	95.63%
3	J48	99%
4	Decision Tree	97.43%



These are the different levels of accuracy generated by different types of classification algorithm (P.Deepika D. S., 2018). Among this the J48 is the algorithm which gives maximum accuracy and less time to detect the thyroid deficiency. The above stated accuracy is shown as pie chart. (K.Thenmozhi. P. , 2014)



## 6. CONCLUSION

The thyroid problem is nowadays found in many people. Early identification of thyroid problem will help to recover from the thyroid. The reviewed survey will help to detect the thyroid problem early. Many classification algorithms are discussed. Among that the J48 is the algorithm which provides the maximum accuracy and it is also less time consuming algorithm. So in future the J48 can be combined with any other advanced methodology to give maximum accuracy and less time consuming.

## 7. REFERENCES

### Bibliography

1. A Kiruthika, P. D. (2018). Predicting Ailment of thyroid using Classification and Recital Indicators. *International Journal of Scientific Research in Computer Science, Engineering and Information Technology*, 4.
2. A vinitha, V. J. (2013). Classification Algorithms in Intrusion Detection System: A Survey. *International Journal of Computer Technology and Applications*, 4.

3. Ankita Tyagi, R. M. (2018). Interactive Thyroid Disease Prediction System Using Machine Learning Technique. *5th International Conference on Parallel, Distributed and Grid Computing*, 5.
4. Aswathi A K, A. A. (2018). An Intelligent System for Thyroid Disease Classification and Diagnosis. *2nd International Conference on Inventive Communication and Computational Technologies*, 4.
5. Bibi Amina Begum, D. P. (2019). Prediction of thyroid Disease Using Data Mining Techniques. *5th International Conference on Advanced Computing and Communication Systems*, 4.
6. K.Sindhya, M. (2020). Effective Prediction of Hypothyroid Using Various Data Mining Techniques. *EPRA International Journal of Research and Development*, 7.
7. K.Thenmozhi., P. (2014). Heart Disease Prediction Using Classification with different Decison Tree Techniques. *International Journal of Engineering Researh and General Science, Vol-2, Issue-6*.
8. K.Thenmozhi., P. M. (2014). Different Data Mining Techniques involved in Heart Disease Prediction. *International Journal of Scientific Research, Vol-3*.
9. Muhammad Anjum Qureshi, K. E. (2017). Expert Advice Ensemble for Thyroid Disease Diagnosis. *IEEE*, 4.
10. P Deepika, S. S. (2016). Anticipating Heart Disease using C4. 5 Classification Augmented with Feature Selection. *International Journal for Research & Development in Technology*, Vol-6.
11. P.Deepika, D. S. (2018). A Noval Classification and Prediction Algorithm for Heart disease Identification. *International Journal of Engineering Science Invention, Vol-7, Issue-2*.
12. P.Deepika, S. D. (2019). An Effective Archetype Design of Heart Disease Anticipation using Optimization Techniques. *EPRA International Journal of Research and Development (IJRD)*, vol-4, Issue-11.
13. Qiao pan, Y. Z. (2016). Improved Ensemble Classification Method of Thyroid Disease Based on Random Forest. *8th Internatioanl Conference on Information Technology in Medicine and Education*, 5.
14. Umar Sidiq, D. M. (2019). Diagnosis of various Thyroid Ailments using Data Mining Classification Techniques. *International Journal of Scientific Research in Computer Science, Engineering and Information Technology*, 6.
15. Vinitha, V. J. (2015). Intrusion Detection System Using Multiclass Batch Algorithm. *International Journal of Advanced Research in Computer and Communication Engineering, Vol-4, Issue-2*.



# INVESTIGATION OF PEA POD CHEMICAL CONSTITUENTS RESPONSIBLE FOR WATER TREATMENT

**Muhammad Muhammad Makki**  
*University of Bahri, Khartoum Sudan*

**Dr. Osama Mohamed Ahmed Adam**  
*Sudan University of Science and Technology, Khartoum Sudan*

**Prof. Salih Elhadi Mohamed Ahmed**  
*Sudan University of Science and Technology, Khartoum Sudan and Bahri University, Khartoum Sudan*

## ABSTRACT

Natural coagulants are considered affordable and efficient substitutes to chemical coagulants for use in developing countries where raw materials such as *Cicer arietinum* (green pea) are readily available. This study investigates a suitable method of processing Pea pod for application in water treatment and investigates the Pea pod chemical constituents responsible for water treatment. Phytochemical analysis was firstly conducted on the Pea pod of the plant to confirm the presence of Chemical and bioactive constituents of Pea pod that was responsible for the water treatment. The result analysis confirmed the presence of Aspartic/Glutamine Protein (amino acid) as the active agent having phytodisinfectant/antioxidant, phytochemical softening property in water purification and constituted the photochemical. It was recommended research should be conducted on the type and extent of these antioxidant and antibacterial substances, on the modes of attack of the Pea pod extracts on microorganisms and other parts of Pea should be investigated to find its chemical constituents.

**KEYWORDS:** Pea Pod, Chemical constituents, Water treatment

## 1.0 INTRODUCTION

Turbidity in water occurs due to the presence of colloidal particles which can mainly be treated by the use of coagulants. This happens due to the presence of polyelectrolyte, proteins, lipids, carbohydrates and alkaloids containing  $-COOH$  and free  $-OH$  surface groups in the seeds (National Research Council, 2006). For instance, comparative study on the coagulation property of *M. oleifera* seed and pod extract by Modibbo (2016) reported promising results

Coagulation with extracts from natural and renewable vegetation have been widely practiced (International Crops Research Institute for the Semi-Arid Tropics, 2014).

Coagulation takes place when coagulants contain significant quantities of water-soluble proteins which carry an overall positive charge when in solution. The proteins bind to the predominantly negatively charged colloidal particles. Coagulation happens when the positively and negatively charged particles are chemically attracted together. They can then accumulate to form larger and heavier particles that settle easily, reducing turbidity level of the given water sample (MRWA, 2003). Coagulation may also improve the microbiological quality of water (MRWA, 2003)

*Cicer arietinum* (green pea) is a legume of the subfamily Faboideae of the flowering plant family (Saha *et al.*, 2014). It is known as gram or Bengal gram



or Egyptian pea. Ancient people associated pea with medical uses. It is widely grown in India, Turkey, and Nigeria. It is an annual plant with a life cycle of one year. The immature peas are used for vegetable. Fresh, canned or frozen matured peas are used as dry peas or slit peas. It is starchy, high in fiber, vitamins, minerals, proteins and lutein. The dry weight obtained is approximately 1/4 protein, and 1/4 sugar (Saha *et al.*, 2014). Various researches on the nutritional value of pea were conducted by a number of researchers including Meenakshi (2015), and on its coagulating characteristics by Marina *et al.* (2005). In addition, Saha *et al.*, (2014) reported that the presence of bioactive compounds in pea pod is equal to that present in pea cotyledon or seed. As such, this research focuses on investigate the Pea pod chemical constituents responsible for water treatment.

The aim of this research is to investigate a suitable method of processing Pea pod for the application in water treatment and investigate the Pea pod chemical constituents responsible for water treatment

## 2.0 METHODOLOGY

### SAMPLE COLLECTION AND PEA POD SEED EXTRACT PRAPARATION

Some amounts of peas were procured locally from Yankaba market Kano, and the pods were separated from the seeds, dried under the sun for about 7days. The pea seed and pea pods were separately ground to fine powder using the mill of a domestic blender. All ground materials were sieved through 0.4-0.6mm BS membrane sieve, and then fractioned with particle size less than 0.4mm was used in the experiments. Mature pea seed and pea pods showing no signs of discoloration, softening or desiccation were used (Musa, 2016)

### PHYTOCHEMICAL ANALYSES OF PEA POD

Complete proximate standard procedure analyses of the pea seed and pod were done in

department of animal science and also in biochemistry department Bayero University Kano.

Also chemical composition analysis was conducted at NGS Kaduna as follows:

### ANALYSIS

Energy Dispersion X-Ray Fluorescence (EDXRF) spectrometer of model "Minipal 4" was used for the analysis.

About 20g of the powdered sample carefully placed in a sample cup. The cup and the sample were placed in measuring positions on a sample changer of the machine. The following condition sets were made as the machine was switched on.

- Elemental composition determination
- Nature of the samples to analyzed as press powder (pellet)
- The current used as 14kv for major oxides, 20kv for the trace elements/rare earth metals (oxides).
- Selected filters were "Kapton" for major elements, Ag/Al-thin for the trace elements/rare earth metals.

The selection of filters was guided by a given periodic table used for elemental analysis. Time of measurement for each sample was 100 seconds and the medium used was air throughout.

The machine was then calibrated by the machines gain control, after which the respective samples were measured by clicking the respective positions of the sample changer.

LOI was determined gravimetrically by heating 1g of the powdered sample in a cleaned weighed crucible at 1000°C. After which the crucible and the content was weighed to get the difference in weight before and after heating.

$$LOI = ((a-b)/1) \times 100\% = H_2O^+$$

Where a = weight of crucible + 1g of the sample before heating

b = weight of crucible + 1g of the sample after heating

## 3.0 RESULT AND DISCUSSION

A. Table 4.1.1: PROXIMATE ANALYSES OF PEA POD SAMPLES

Constituents	Pea pod sample A (%)	Pea pod sample B (%)
ASH	7.62	7.43
MOISTURE	3.98	4.33
CP	8.49	9.06
CF	20.15	19.77
Ee	1.10	0.97
CHY	33.38	32.90
NFE	62.64	62.77

%ASH: % Ashing

%MOIST: % moisture content

% CP: % Crude protein content



% CF: % Crude fibre content

% Ee: % Fat content

% CHY: % Carbohydrate content

% NFE: % Nitrogen Free Extra content

Pea pod chemical oxides analysis was done at National Geoscience Research laboratory Kaduna, Nigeria with reference number (LABORATORY REPORT: NGRL/OP/5334/3222). The following chemical oxides of pea pod were confirmed.

**B. Table 4.1.2: PEA POD CHEMICAL OXIDES**

OXIDE COMPOSITION	% CONTENT
SiO <sub>2</sub>	4.00
Al <sub>2</sub> O <sub>3</sub>	43.20
P <sub>2</sub> O <sub>5</sub>	5.90
K <sub>2</sub> O	32.30
Na <sub>2</sub> O	1.08
CaO	ND
TiO <sub>2</sub>	ND
Cr <sub>2</sub> O <sub>3</sub>	ND
V <sub>2</sub> O <sub>5</sub>	ND
MnO	0.24
Fe <sub>2</sub> O <sub>3</sub>	1.90
CuO	0.80
ZnO	0.53
Br	ND
SrO	ND
ZrO <sub>2</sub>	ND
Ag <sub>2</sub> O	ND
As <sub>2</sub> O <sub>3</sub>	0.08
BaO	ND
effLOI	9.46
PbO	0.51

ND = Not Detected

The result of physiochemical analysis of the pea pod shows the presence of Protein (amino acid) as the active agent having phytodisinfectant/antioxidant, phytocoagulant and softening property in water purification and constituted the photochemical. Photochemical are chemical compounds formed during the plants normal metabolic processes (Musa 2016).

Protein is reported to be the main component responsible for coagulation-flocculation process. Research by Udaya *et al.*, (2013) finds that the extraction of Pea showed the presence of active agents close to masses of Aspartic/Glutamine. Research by Meenakshi (2015) on the chemical analysis of pea pod powder shows almost the same presence of chemical constituents found in the pea pod powder which are responsible for coagulation.

The presence of polyelectrolyte such as proteins and carbohydrates containing -COOH and free -OH surface groups in the pods was confirmed, since most of the particles in water are negatively charged, any positive ion like sodium compound contributes a monovalent ion Na<sup>+</sup>, a Calcium compound contributes a divalent Ca<sup>2+</sup>, Aluminum and Iron compounds contributes trivalent ions Al<sup>3+</sup> and Fe<sup>3+</sup> which will neutralize the negative ion in H<sub>2</sub>O compounds, bind them together and form heavier turbid particles reducing turbidity level. The mechanism for hardness removal is adsorption and conversion of soluble

hardness-causing substances to insoluble products by precipitation while the mechanism of disinfection is ant oxidation.

Bichi (2013) reviews that the active ingredient responsible for coagulation in *M. Oleifera* was polyelectrolyte, and this also applies to other natural coagulants (including pea pod extract).

Similar properties was reported by Yongabi *et al.*, 2010 that *M. oleifera* seeds, *J. curcas* seeds and calyx of Hibiscus sabdariff process both phytodisinfectant and phytocoagulant property in water purification.

#### **4.0 CONCLUSION AND RECOMMENDATION**

A suitable method was employed for the Pea pod processing and phytochemical analysis confirmed the presence of Aspartic/Glutamine Protein (amino acid) as the active agent having phytodisinfectant/antioxidant, phytocoagulant softening property in water purification and constituted the photochemical.

It was recommended research should be conducted on the type and extent of these antioxidant and antibacterial substances, on the modes of attack of the Pea pod extracts on microorganisms and other parts of Pea should be investigated to find its chemical constituents.



**REFERENCE**

1. Bichi, M.H. (2013). *A Review of the Applications of Moringa oleifera Seeds Extract in Water Treatment. Civil and Environmental Research (Online). Vol.3 (8): 1-10.*
2. *International Crops Research Institute for the Semi-Arid Tropics, (2016). Vol. 1. 4 (4): 22*
3. Marina B. Sciban, Mile T., Klasnja and Jelena LJ.Stojimirovic "Investigation of the coagulation activity of natural coagulants from seeds of different leguminous species" *APTEFF, 36, 1-266 (2005).*
4. Meenakshi Garg, (2015). *Nutritional Evaluation and Utilization of Pea Pod Powder for Preparation of Jaggery Biscuits. Research Article Food and Processing Technology, Vol.6 (12): 1-4.*
5. Meenakshi Garg. "Nutritional evaluation and utilization of pea pod powder for preparation of jaggery biscuits" *Research article Food and Processing Technology, 2015.*
6. Modibbo, A. (2016). *A Comparative Study on the Effectiveness of Moringa oleifera Seed and Pod Extracts for Turbidity Removal from Surface Water; Unpublished M.Eng. Dissertation, Department of Civil Engineering, Bayero University Kano.*
7. MRWA, (2003): *Coagulation and Flocculation Process Fundamentals. MRWA: Minnesota Rural Water Association. Pp. 30*
8. Musa H. (2016). *Water Treatment using Piliostigma thonningii schum and Tamarindus indica l. leaves Extracts. Unpublished M.Eng. Dissertation. Department of Civil Engineering, Bayero University Kano.*
9. *National Research Council (2006), Okra, lost crops of Africa: volume ii: vegetables lost crops of Africa 2. National Academic Press.*
10. Udaya Simha L, roopa. S and C. T. Puttaswamy (2013). *Investigations of natural coagulants on water quality parameters. International journal of earth science and engineering. ISSN 0974-5904, Volume 06, No. 06(01).*
11. Yongabi K A, Lewis D. M and Harris P. L (2011). *Application of phytodisinfectants in water purification in rural Cameroon. African Journal of Microbiology Research Vol. 5(6) pp. 628-635, 18 March, 2011.*



# THE ECONOMIC GROWTH FORECAST AND A REVIEW OF THE IMPACTS OF COVID-19 ON THE GHANAIAN ECONOMY: APPLICATION OF TIME SERIES ANALYSIS AND MONTE-CARLO SIMULATION

**Professor Li Fang Lin<sup>1</sup>**

*Professor, School of Finance and Economics, Jiangsu University No.301 Xuefu Road, Zhenjiang, 212013, Jiangsu Province, P. R. China<sup>1</sup>.*

**Blessed Kwasi Adjei<sup>2\*</sup>**

*Masters Student, School of Finance and Economics, Jiangsu University No.301 Xuefu Road, Zhenjiang, 212013, Jiangsu Province, P. R. China<sup>2</sup>.*

**Felix Kwame Nyarko<sup>3</sup>**

*PHD Candidate, School of Finance and Economics, Jiangsu University No.301 Xuefu Road, Zhenjiang, 212013, Jiangsu Province, P. R. China<sup>3</sup>.*

Article DOI: <https://doi.org/10.36713/epra4427>

## ABSTRACT

*This manuscript explores the effects of Covid-19 pandemic on the economic activities of Ghana by first modelling the Economic growth figures of Ghana; discuss the current covid-19 situation and its economic impact on the nation and to wrap things up by suggesting remedial measures necessary to salvage the situation at hand. To model and forecast the Economic growth trend, the times series analysis and the Monte Carlo simulation (Laplace distribution) techniques were employed. The success of the ARIMA model was monitored through Akaike information Criterion (AIC) where irrefutably the absolute number shows the success of the model - the lower the number, the better the model.*

*The research results showed that in spite of promising economic forecasts, with the force of the pandemic soaring universally, there is no doubt that the economic prosperity of Ghana will be disrupted and major revenue margins shrunk this year. However, due to some solid and harsh measures set out by the government we are optimistic that situations will be well contained and managed. The scientific contribution of the research lies in the fact that it will offer a new way of perceiving risks and uncertainties when policy makers are drafting budgets and economic policies going forward. In that capacity, they will not only adapt to practical and analytical methods to forecast but additionally consider some unforeseen circumstances beyond the control of humanity that may have tormenting impact on economic outputs.*

**KEYWORDS:** *Time series analysis, Covid-19, Monte-Carlo simulation, GDP per Capita, Modelling, Economic Growth.*



## 1. INTRODUCTION

A fundamental method to gauge a nation's Economic development and prosperity is by following its GDP per capita performances year on year. These figures by and large show how much the economic production value can be credited to every individual resident. Governments then again broadly use GDP per capita to understand how the economy is developing with its populace hence it is important for us to focus on this variable's contribution to understand how an economy is growing or contracting in terms of its people.

Theoretically, if a country's GDP per capita is growing with a stable population level it can conceivably be the consequence of innovative strategies that are producing more with the same population size. Some countries may have high GDP per capita but a small population and this may mean that they have built up a self-sufficient economy based on an abundance of special resources. Notwithstanding, a country may have predictable economic growth but if its population is growing faster than its GDP, then GDP per capita will be on a descending pattern. This is normally the situation of numerous African countries. There are many speculations concerning why African countries are so poor. One of the most credible reasons is essentially a

direct result of the populace and economic size. Small economies in Africa mostly find it difficult building economies of scale as compared to other advance nations. Also, numerous African nations are landlocked, which means they don't have direct access to the global exchanging partners. They depend on neighbouring nations to get their products to the global market. This move increases their operative cost and results in less competitive prices. Indeed, even African nations with ports face enormous transportation costs in getting their products to other foreign markets.

More importantly, global forecast of per capita GDP helps provide comparable insight on economic prosperity and economic developments across the globe. Both GDP and population are factors in the per capita equation. The IMF therefore provides a regular outlook on global growth with insights on both GDP and GDP per capita. As per the estimates it expects little change in the rankings of the best ten (10) nations as drowsy growth data is trending across the globe. The IMF expects GDP growth worldwide of 3.2% in 2019 to marginally pickup in 2020 to 3.5%. The IMF's 2019 and 2020 per capita GDP expected rankings include the following:

Country	GDP Per Capita (USD, 2019)	GDP Per Capita (USD, 2020)
Luxembourg	\$113,200	\$116,730
Switzerland	\$83,720	\$86,670
Macao SAR	\$81,150	\$80,070
Norway	\$77,980	\$78,330
Ireland	\$77,770	\$80,260
Qatar	\$69,690	\$70,740
Iceland	\$67,040	\$66,600
United States	\$65,110	\$67,430
Singapore	\$63,990	\$64,830
Denmark	\$59,800	\$61,730

**TABLE 1. GDP per Capita forecast by IMF for top 10 GDP per capita countries**

These forecasts are profoundly significant as they can assume a significant job in advancing the economic success or failure of a country. Likewise it diminishes vulnerability such as economic downturn, recession and other risks beyond human control and sufficiently helps policy makers to envision change in the economic conditions. Some other benefits are the abundance of information made accessible to people of these nations. Moreover, a promising forecast is compelling to investors who may be keen on putting money into a country.

### 1.1 Significance of the Research

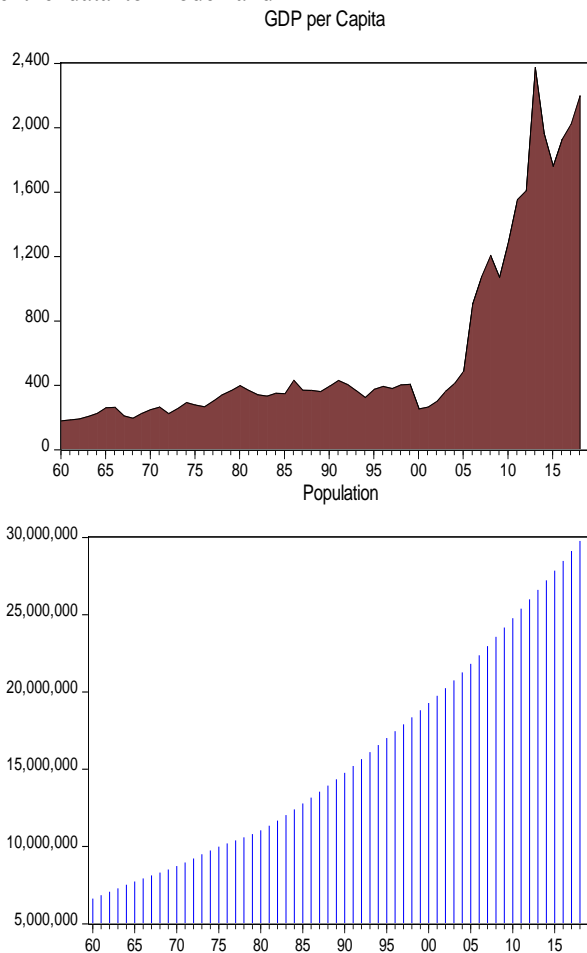
This research mainly seeks to employ time series models and the Monte Carlo simulation

techniques to first predict the economic growth trend of Ghana, discuss the current economic situation of Ghana and how the Covid-19 pandemic will take its toll on the economy and lastly put across some mitigating strategies planned out by the Government to tone down the effects of the pandemic and also add some few policy suggestions. The outcome of the study will have a long term effect on the economy even after the pandemic is long gone since policy makers will be more guided henceforth to put into consideration certain uncontrolled risks factors when making economic policies and drafting budgets for the years ahead.



To perform this analysis, we obtained the yearly GDP per capita and population datasets from the World Bank indicators site and it spanned from 1960 to 2019. Also we collected the datasets on Ghana’s covid-19 cases from Statista. The first being the GDP per capita will be the data to model and

predict the economic trends of Ghana. Then again the population data and that on the covid-19 cases will be used to legitimize the need to concentrate on unexpected conditions that tend to affect economic trends in Ghana going forward.



**Figure 1 Raw data of GDP per Capita and Population of Ghana**

**2. PROBLEM STATEMENT**

As the adage goes "anyone who has seen a convertible trapped in a rainstorm comprehends the significance of weather forecasts", a similar relationship can be ascribed to economic forecasts. Economies as compared to the weather can be particularly questionable now and again and thus the requirement for computations and predications. These figures build confidence and assurance in an economy and causes people to feel progressively hopeful about what's to come. Nonetheless, in spite of how precise or careful these forecasts might be there are always some sorts of environmental uncertainties that are beyond the control of mankind and for which individuals ordinarily think little of. Instead of believing the entirety of any

predictions about the future, we ought to consistently as a country attempt to create plans that will be delicate to shocks.

Taking a gander at the great economic recession of 2008 that devastated world financial markets just as the banking and real estate industries made a huge number of individuals lose their life savings, their jobs and their homes, the Great depression that endured from 1929 to 1939 and made a huge number of financial specialists loose immense total of cash because of the crash in the stock market, it is very much certain that this pandemic would have a drastic impact on economies after the circumstance is at long last managed. To the developing economies like Ghana some of the problems attributable to the covid-19



will be the difficulties going to be encountered in handling the effects of the crisis, since the amount of aid needed to fight the virus will be much greater than the resources available to cushion the threats of the lockdown. In addition, the health care available to most people in Africa is much poorer. Another problem that will be witnessed massively is the increment in capital flights from developing economies by multinationals.

### 3. TIME SERIES MODELLING AND FORECASTING

Time series datasets are series of time dependent recordings of processes or phenomena. Typically these recordings can either be continuous in nature or discrete observations. A time series containing records of a single variable is termed as univariate. In any case, if records of more than one variable are thought of, it is named as multivariate. In this paper we will concentrate on the scenario where observations are made at discrete equally spaced times. The consecutive observations of the discrete datasets are recorded at equal time intervals and mathematically defined as a set of vectors  $x(t)$ ,  $t = 0, 1, 2, \dots$  Where  $t$  represents the time elapsed.

Generally speaking one vital concept worth noting with time series analysis is stationarity. Simplistically, stationary time series process exhibit invariant properties over time with respect to the mean and variance of the series. Meaning its behaviour does not change over time or that their values always tend to vary about the same level and that their variability is constant over time. On the other hand for non-stationary time series, the mean, variance or both will change over the trajectory of the time series. The importance of stationary time series to a research is its ability to succinctly give a more valid representation when used to develop analytical models against which forecasts can be produced. Through a process of differencing, non-stationary time series datasets can be reduced to stationary time series. Although there are a number of things which are of interest in time series analysis, our research will focus on two vital purpose; Modelling and Forecasting.

Time series modelling is a powerful research area which involves carefully collecting and rigorously studying the past observations of a time series to develop an appropriate model which describes the inherent structure of the series. This model may depend on unknown parameters and these will need to be estimated. This model is then used to generate future values for the series, i.e. to make forecasts. Time series forecasting thus can be termed as predicting what the value of  $Y_{t+M}$ , ( $M \geq 1$ ) will be and possibly give an indication of what the uncertainty is in the prediction. It is obvious

that a successful time series forecasting depends on an appropriate model fitting. One of the most popular and frequently used stochastic time series models is the Autoregressive Integrated Moving Average (ARIMA) model which will also be used in this study. The basic assumption made to implement this model is to consider the time series as linear and also that it follows a particular known statistical distribution, such as the normal distribution. ARIMA model has subclasses of other models, such as the Autoregressive (AR), Moving Average (MA) and Autoregressive Moving Average (ARMA) models. The popularity of the ARIMA model is mainly due to its association with the Box-Jenkins methodology (**George Box and Gwilym Jenkins, 1970**) for optimal model building process which postulates the following intuitive steps;

- Identifying whether the time series is stationary or not, how many differences are required to make it stationary, plotting the Autoregressive plots and partial autoregressive plots. Both plots are drawn as bar charts showing the 95% and 99% confidence intervals as horizontal lines. Bars that cross these confidence intervals are therefore more significant and worth noting.
- Estimating the data to train the parameters of the model (i.e. the coefficients).
- Doing a diagnostic Check of the fitted model in the context of the available data and check for areas where the model may be improved.

#### 3.1 Establishing the stationary assumption

The basic prerequisite of time series modelling is that the stationary of our GDP per capita time series data needs to be established. Here two measures are presented to verify the stationary of the data (the subjective and the objective). Each of these processes has its merits and demerits. The subjective method is based on the idea of illustrative assessment of the correlogram of autocorrelations and partial-autocorrelations at different lag levels. The objective method is more mathematically inclined and uses the Unit Root Tests and the Augmented Dickey Fuller (ADF). Within this study both the objective and subjective measures are used for checking the stationarity of the data set. If it is not stationary, that is  $I(0)$ , then we will have issues with auto-correlation in our residuals, which violates an essential assumption made by many statistical models and theories. The disadvantage of a model based on non-stationary datasets would be its bad predictive ability, hence implying we apply first or second level





differencing. It is therefore appropriate to accept that stationary will imply that the mean and variance of the series do not vary over time.

### 3.1.1 Unit root test

Considering the approach to unit root testing we implicitly assume that the time series to be tested can be written in the form  $Y_t = D_t + Z_t + \varepsilon_t$ . Where,

- $D_t$  is the deterministic component (trend, seasonal component, etc.)
- $Z_t$  is the stochastic component.
- $\varepsilon_t$  is the stationary error process

The task of the test is to determine whether the stochastic component contains a unit root or is stationary. Autoregressive unit root tests are based on testing the null hypothesis that  $\phi = 1$  (difference stationary) against the alternative hypothesis that  $\phi < 1$  (trend stationary). They are called unit root tests because under the null hypothesis the autoregressive polynomial of  $z_t$ ,  $\phi(z) = (1 - \phi z) = 0$ , has a root equal to unity.

### 3.1.2 The Augmented Dickey Fuller test

The time series data are subjected to the Augmented Dickey fuller test to verify if the null hypothesis has a unit root present in a time series sample. The augmented version of the Dickey–Fuller test is used instead of just the Dickey fuller test due to the large and more

complicated nature of the time series models. The testing procedure for the ADF test is the same as for the Dickey–Fuller test but it is applied to the model where  $c$  is a constant,  $\beta$  the coefficient on a time trend and  $\theta$  the lag order of the autoregressive process as represented in the mathematical equation below:

$$Y_t = c + \beta t + \theta y_{t-1} + \theta \varepsilon_{t-1} + \varepsilon_t$$

Imposing the constraints  $c=0$  and  $\beta=0$  corresponds to modelling a random walk and using the constraint  $\beta=0$  corresponds to modelling a random walk with a drift. By including lags of the order  $\theta$  the ADF formulation allows for higher-order autoregressive processes. This means that the lag length  $\theta$  has to be determined when applying the test. One possible approach is to test down from high orders and examine the t-values on coefficients. An alternative approach is to examine information criteria such as the Akaike information criterion, Bayesian information criterion or the Hannan–Quinn information criterion. The unit root test is then carried out under the null hypothesis  $\phi=0$  against the alternative hypothesis of  $\phi<0$ . If the p-value is less than the confidence level (alpha value), then the null hypothesis of  $\phi=0$  is rejected and no unit root is present else we accept the null hypothesis and apply differencing.

**TABLE 2** Null Hypothesis: D(GDP\_PER\_CAPITA) has a unit root  
Exogenous: Constant

AT LEVEL		t-Statistic	Prob.*
Augmented Dickey-Fuller test statistic		0.964196	0.9957
Test critical values:	1% level	-3.548208	
	5% level	-2.912631	
	10% level	-2.594027	
AT FIRST DIFFERENCE		t-Statistic	Prob.**
Augmented Dickey-Fuller test statistic		-7.994268	0.0000***
Test critical values:	1% level	-3.550396	
	5% level	-2.913549	
	10% level	-2.594521	

**Note: \*\*\* indicates 1% significance, \*\* indicates 5% significance and \* indicates 10% significance**

After the ADF tests (both at level and at first difference) are applied. The null hypothesis of having unit root is not rejected at level since the p-value of the test statistic exceeds the observed level of significance =0.05. From **Table 2** the results of ADF test on GDP per Capita at level indicates that the hypothesis: GDP has a unit root, is acknowledged meaning the series is non stationary at level. However at first difference the ADF test evidently indicates that the series is stationary with a p-value being less than 0.05. (i.e p-value=0.0000)

### 3.2 The Auto-Correlation Function Plot

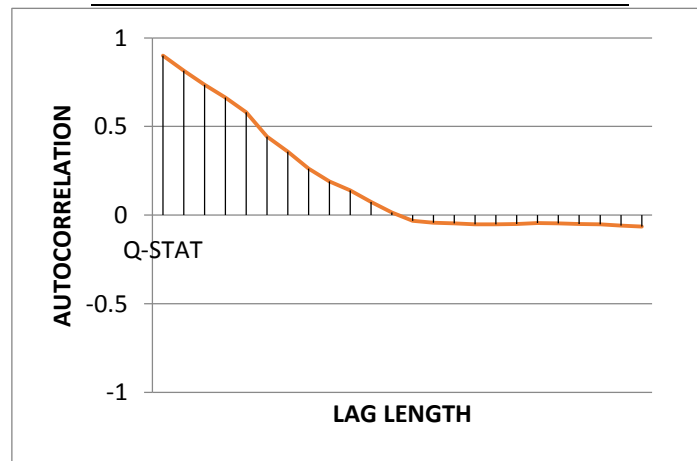
The line of the Auto-Correlation Function (ACF) shows strong positive auto-correlation for the first 12 lags. Then there is a long period of negative auto-correlation for the last 12 lags. This is a good indication that the GDP per capita is non-stationary at level and hence differencing is to be applied to convert it to stationary series. The ACF plot for the differenced GDP per capita, however, becomes stationary. This suggests the GDP per capita is I(1).



Figure 2. The Auto-correlation function (ACF) at level

Sample: 1960 2019  
Included observations: 59

Autocorrelation	Partial Correlation	AC	PAC	Q-Stat	Prob
0.899	0.899	50.181	0.000		
0.815	0.031	92.074	0.000		
0.736	-0.008	126.90	0.000		
0.664	-0.007	155.77	0.000		
0.580	-0.099	178.22	0.000		
0.443	-0.342	191.55	0.000		
0.358	0.153	200.43	0.000		
0.262	-0.120	205.29	0.000		
0.191	0.069	207.93	0.000		
0.140	0.123	209.37	0.000		
0.074	-0.079	209.79	0.000		
0.016	-0.136	209.81	0.000		
-0.032	0.078	209.89	0.000		
-0.042	0.055	210.03	0.000		
-0.046	0.011	210.20	0.000		
-0.052	0.088	210.43	0.000		
-0.052	-0.016	210.67	0.000		
-0.049	-0.060	210.88	0.000		
-0.044	-0.054	211.05	0.000		
-0.046	-0.052	211.25	0.000		
-0.049	-0.043	211.47	0.000		
-0.051	0.053	211.73	0.000		
-0.059	-0.006	212.07	0.000		
-0.064	-0.003	212.49	0.000		



The ACF is presented as graphical plots. The ACF of the non-stationary process shows a gentler decline to zero. **Figure 2** replicates the ACF for a non-stationary GDP per Capita. Conversely, **Figure 3** below provides a scenario of a stationary time series with the associated ACF diagram. From

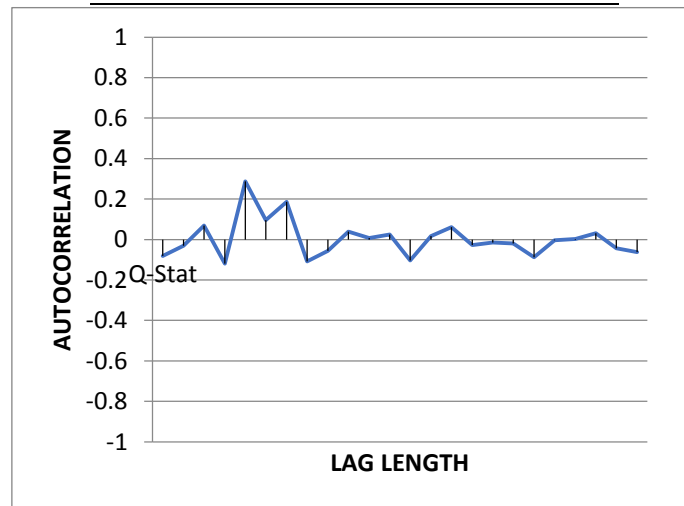
the observations of the stationary time series it shows little or no correlation and is reflected in the ACF plot showing a rapid decline to zero. This means the GDP per capita is integrated to the order 1 and will need to be differenced one time for modelling.



Figure 3. The Auto-correlation function (ACF) at first difference

Sample: 1960 2019  
Included observations: 58

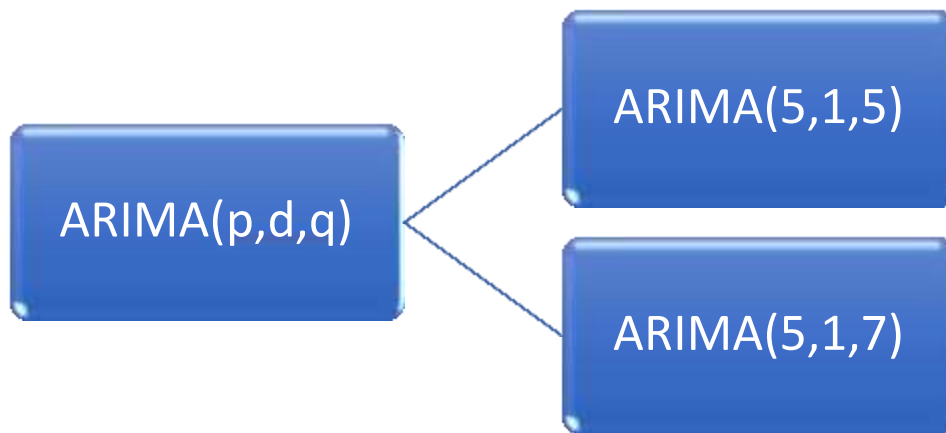
Autocorrelation	Partial Correlation	AC	PAC	Q-Stat	Prob	
		1	-0.082	-0.082	0.4072	0.523
		2	-0.030	-0.037	0.4623	0.794
		3	0.069	0.064	0.7663	0.858
		4	-0.119	-0.110	1.6754	0.795
		5	0.287	0.280	7.1021	0.213
		6	0.096	0.132	7.7191	0.259
		7	0.186	0.268	10.077	0.184
		8	-0.108	-0.126	10.883	0.208
		9	-0.056	-0.003	11.103	0.269
		10	0.039	-0.099	11.214	0.341
		11	0.007	-0.000	11.217	0.425
		12	0.024	-0.178	11.261	0.507
		13	-0.103	-0.119	12.088	0.520
		14	0.016	-0.033	12.110	0.597
		15	0.061	0.174	12.407	0.648
		16	-0.028	0.013	12.473	0.711
		17	-0.015	0.037	12.491	0.770
		18	-0.020	0.038	12.526	0.819
		19	-0.087	-0.007	13.198	0.828
		20	-0.004	-0.066	13.199	0.869
		21	0.003	-0.102	13.200	0.901
		22	0.031	-0.024	13.293	0.925
		23	-0.044	-0.045	13.487	0.941
		24	-0.062	-0.016	13.875	0.949



### 3.3 Estimating possible ARIMA Models and selection

From the initial intuition of Box-Jenkins methodology, which is more prevalent on recognition, to come across the appropriate values of p (Auto-regressive term), d (no of difference taken) and q (moving average term) for time series modelling, it is of best interest we focus on the presentations of correlogram of the auto-correlations and partial auto-correlations. The significance of p is obtained from correlogram of partial auto-correlations and the significance of q is attained from

the correlogram of auto-correlation. From the correlogram of auto-correlations and partial auto-correlations of the first differenced GDP per Capita in **Figure 3** above, it can be seen that significance is achieved at the 5th and 7th points. Therefore two tentative ARIMA Models can be deduced and the best model that fit the series be estimated. Other diagnostic test would be carried out to determine if all the variables have been covered by the applicable model. The two tentative models are ARIMA (5, 1, 5) and ARIMA (5, 1, 7).



**Figure 4 possible ARIMA Model**

**TABLE 3 ARIMA Model Outputs**

ARIMA (5, 1, 5)				ARIMA (5, 1, 7)			
Dependent Variable: D(GDP per Capita)				Dependent Variable: D(GDP per Capita)			
Method: ARMA Maximum Likelihood (OPG - BHHH)				Method: ARMA Maximum Likelihood (OPG - BHHH)			
Variable	Coefficient	t-Statistic	Prob.	Variable	Coefficient	t-Statistic	Prob.
C	30.9529	0.9106	0.3665	C	28.3759	0.5636	0.5753
AR(5)	-0.18504	-0.3368	0.7375	AR(5)	0.33430	2.4510	0.0175**
MA(5)	0.57247	1.0063	0.3188	MA(7)	0.35708	3.4341	0.0011***
SIGMASQ	18527.83	8.7208	0.0000***	SIGMASQ	17445.99	9.5253	0.0000***
F-statistic	2.5305	AIC	12.8207	F-statistic	3.803719	AIC	12.7693
Prob(F-statistic)	0.0667*	Durbin-Watson stat	2.1983	Prob(F-statistic)	0.015133**	Durbin-Watson stat	2.1204

**Note: \*\*\* indicates 1% significance, \*\* indicates 5% significance and \* indicates 10% significance**

From Table 3 it can be observed that between the two models, ARIMA (5, 1, 7) is the best model to be employed for forecasting. The criteria used in selection were based the highest number of significant values (3 significant coefficients), the least volatility (SIGMASQ), the lowest Akaike info criterion (AIC) and lastly the significance of the F-statistics.

**3.4 Time series analysis forecast of the GDP per capita**

The graph below as observed in Figure 5 indicates the plot of the forecasted GDP per Capita and actual GDP per capita figures. Despite some little variations between the forecasted GDP per capita and the actual from 2011 to 2015 it can be seen that both lines have been on an upward trend over the years. An extrapolation therefore of both lines will indicate the GDP figures of Ghana will continue on its upward trend.

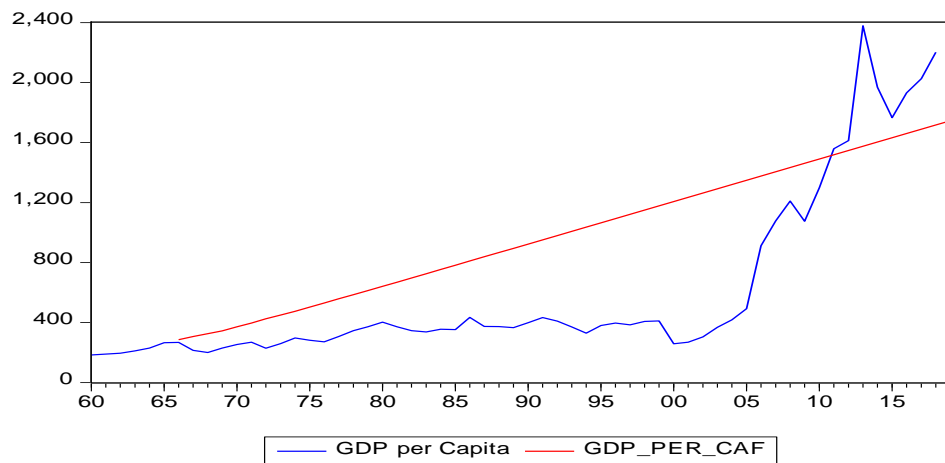


Figure 5. Graph of the forecasted GDP per capita vs. Actual GDP per capita figures

#### 4. PREDICTING GDP PER CAPITA BY MONTE CARLO SIMULATION

Every now and again, in real world situations because of the unpredictability of economic uncertainties it may not be conceivable to assess precisely the economic behaviour by applying analytical methods. Under such conditions an alternative approach to model such system is through creating a simulation. Concisely, simulation methods provide an alternative approach to studying economic and financial behaviour through creating an artificial replication of real economic data series.

The strategy mimics sets of random figures from the underlying probability distribution of the process under investigation. A particular utilization of the Monte Carlo method is dependent on the

nature of the underlying probability distribution of the process under investigation.

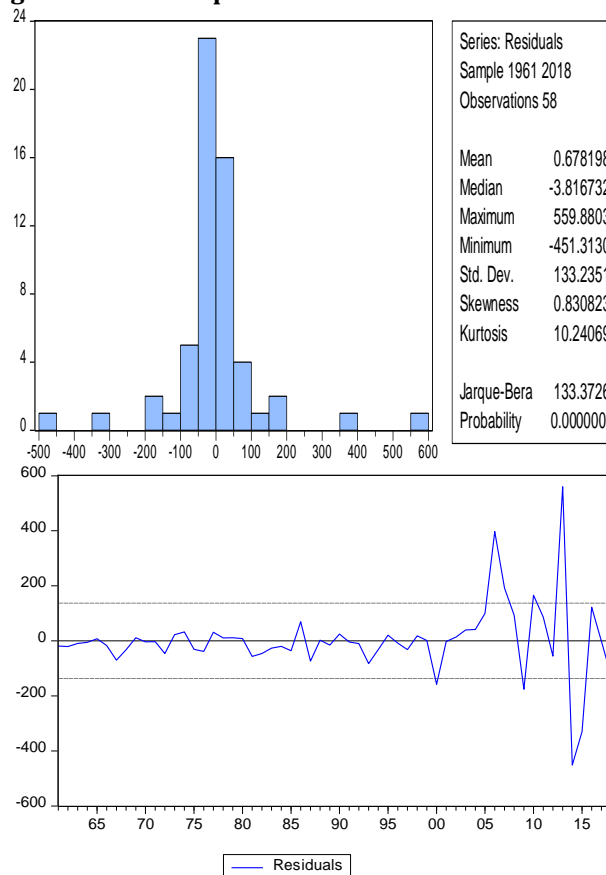
##### 4.1 Picking a Distribution for the Prediction (Laplace Distribution)

After choosing the simple ARIMA model of order (5, 1, 7), its residuals are carefully examined. From Figure 6 the plots of the residuals appear stationary with the mean of the distributions being roughly zero, hence indicating that the residuals are distributed normally. If a line is drawn through the histogram, it will be roughly bell-shaped and centered at 0. The fitting function indicates the Laplace distribution is a reasonable distribution to use for our Monte Carlo simulations, because it has tails heavier than the Normal distribution and more suitable for the modelling of financial returns and economic trends.





**Figure 6. Residual plot the selected ARIMA model**



**4.2 Monte Carlo Simulation (Predicting using Laplace distribution)**

Now we can generate empirically derived prediction intervals using our chosen distribution (Laplace). By definition the Laplace distribution will be modelled mathematically as:

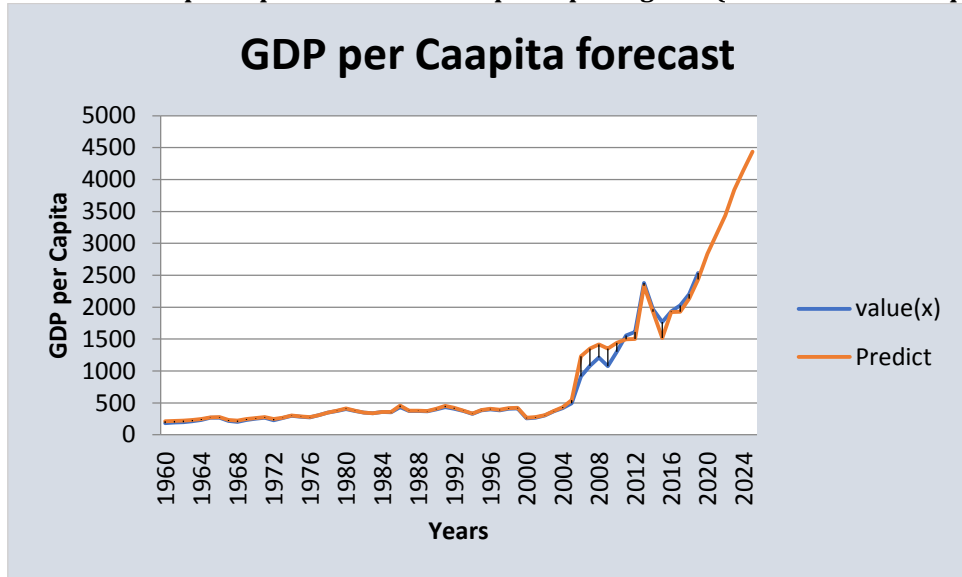
$$p(x) = \frac{1}{2b} e^{-|x-u|/b} \text{ and } b = \frac{1}{N} \sum_1^N |x - u|$$

The mean is the predicted GDP per capita, because the residuals were centered at zero. The beta

is calculated from the residuals as the mean absolute distance from the mean. It is a way of measuring the length of the tails. The percentage of actual GDP per capita values within our prediction interval is 100% (other runs had it around 99.6% prediction intervals hence does not seem too wide). We plotted the prediction intervals along with the actual GDP per capita values and the actual GDP per capita values do appear exactly as we want.



Figure 7. Forecasted GDP per capita vs. Actual GDP per capita figures (Simulation technique)



### 4.3 Comparison of the two Forecasting Methods

Plots from Figures 5 and 7 both show the forecasted lines against the actual over the period under study and beyond. One common thing is the similarity in both of the forecasted signals and plots. Though the simulated forecast (Laplace distribution) shows a more clear and logical output than that produced by the time series methods, both forecast tells the same story and that is an uptick of Economic prosperity for Ghana in 2020 and beyond. The consistency of the forecast plots imply that each of the modelling process employed is robust hence indicating the reliability of the trend lines and direction.

### 5. ECONOMIC FORECAST OF GHANA AND THE COVID-19 PANDEMIC

With forecasts giving positive indications of a promising Economic upswing in 2020 and beyond for Ghana it is also appropriate we indicate that this future is unrealistic particularly with increasing trends of Covid- 19 cases in Ghana and the world at large.

Covid-19 has progressively become a global canker and was first reported in Ghana on 12 March 2020, it has since heightened to 2169 cases; with 229 recoveries and 18 deaths as at the close of 3rd May 2020. This translates to a recovery rate of about 11.0% and mortality rate less than 1%. Anyway with respect to the whole populace just about 0.00723% of the roughly 30 million people are infected as of now.

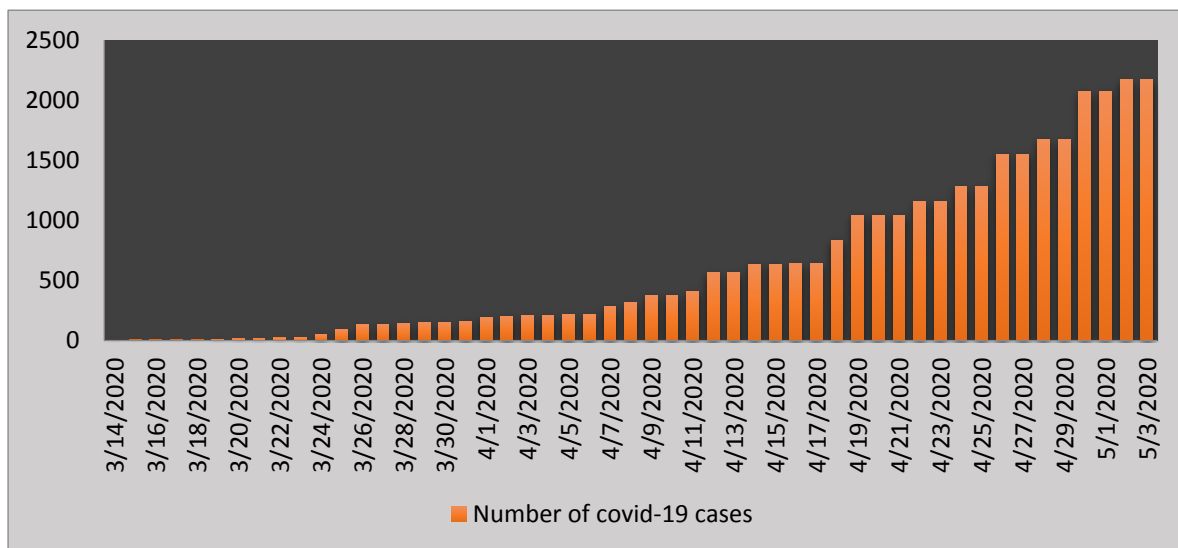


Figure 8. Covid-19 cases in Ghana as at 3<sup>rd</sup> May 2020.



It is therefore important for the Government to restrict and stop the importation of the virus and furthermore contain its spread to a larger part of the people in light of the fact that a vast number of these individuals constitute the working force of the nation and their outputs contribute to the economic growth a great deal. Most of the response strategies put forward by the Government were largely motivated by countries earlier hit by the virus, especially Asia and Europe. These actions are: the closure of all borders, mandatory quarantine and testing of incoming travellers and partial lockdown of selected areas identified as high risk regions. With these harsh measures one can dare to dream that the number of infected persons will slow and perhaps flatten the curve but the pandemic's invincible economic impact cannot be overlooked. Some sectors through which the economy of Ghana would be exceptionally affected are in the direction of international trade, hospitality sector, investment avenues, FDI flows and oil revenues.

### **5.1 Covid- 19's impact on the Ghanaian Economy**

With Ghana being a part of the international trade market and having international trade alone representing about 68.3% of its GDP, this at that point implies the pandemic is probably going to have a huge adverse impact on the country's international trade and reserves should it persists longer than foreseen. Globally, as many countries tend to look inwards and produce necessities for their own consumption, it implies that export trade would decline and revenues shrunk. Job losses will likewise be on the upsurge and this could thus disintegrate the economic gains achieved in recent years and fundamentally hinder Ghana's economic development. The top 5 import origins of Ghana being China (US\$3.3 billion), United States (US\$1.0 billion), Belgium (US\$0.7 billion), India (US\$0.7 billion), and the United Kingdom (US\$0.6 billion) have also been hit hard with this virus. In this light, the Government envisions a drop in anticipated GDP growth for 2020 at 2.6%, which is essentially lower than the budgeted GDP growth of 6.8% computed earlier for the year.

As far as foreign direct inflows, the outbreak and associated lockdowns across the globe would prompt decreases in worldwide settlements and portfolio investments to developing economies including Ghana. Additionally FDI streams from the hospitality industry will be adversely impacted due to closure of borders and travel bans as a result of the pandemic. The fear of FDI slump will be further amplified by the fact that already some major multinational companies (MNCs) have on average revised their earnings downwards by 9%. Developing countries MNCs would be the worst

affected, with profit now projected to fall by 16%. As long as this episode lingers, portfolio investments to emerging economies would decline and there are likely to be capital reversals as investors in advanced economies seek liquidity to enable them cope with economic downturns in their countries. Therefore, the Ghanaian economy is likely to suffer some reductions in portfolio inflows. Also, additional borrowing and related expenses that will be incurred is likely to increase the country's debt risk. The spontaneous increment in Government expenditures, particularly in the health sector, could adversely impact the fiscal deficit. Government estimates that events unfolding as a result of Covid-19, even with some mitigating measures, will result in a deficit of 6.6% of revised GDP, which is higher than the de facto fiscal rule of 5% established by the Fiscal Responsibility Law.

With Ghana presently being a net exporter of oil, income misfortunes are envisaged. An average crude oil price per barrel of US\$58 was conceived in the 2020 financial plan, however with unrefined petroleum costs presently hitting record lows, the income deficits could be colossal, and could prompt Ghana missing oil income targets. This would require an update of oil income targets and finding creative approaches to plug the financing escape clause. Ghana is among the main 10 fuel trading nations in Africa with fuel exports averaging US\$3.1 billion from 2016 to 2018. UNCTAD estimates that Africa would lose around US\$65 billion in fuel exports to the Corona virus outbreak. This would impact heavily on countries that are heavily dependent on fuel exports. At the moment, fuel exports comprise 23.3% of Ghana's total exports. This means, should the outbreak prolong, the impact on export revenues and possibly economic indicators of Ghana would be immense.

### **6. CONCLUSION**

With time series modelling and forecasting and Monte Carlo simulation proving beneficial to the scientific literature in predicting trends, this year, Covid -19 has added an alternate curve to these expectations. Taking everything into account the GDP and economic growth of Ghana was expected to be on an upward trend quite similar to trends witnessed in 2019 if not better. However with current developments especially with the increase in number of Covid-19 cases worldwide, a lot of pragmatic measures have to be in place if the adverse effects of the pandemic are to be contained and mitigated. A few arrangements being set up by the Ghanaian Government worth complimenting are the establishment of a Corona virus Alleviation Programme (CAP) to facilitate economic recovery.



This will lower the cap on Ghana Stabilisation Fund (GSF) from the current US\$300 million to US\$100 million to allow for transfer of excess funds to the CAP. Likewise there will be a revision of the Petroleum Revenue Management Act (PRMA) to allow for withdrawal from the Ghana Heritage Fund to help in battling Covid-19. Bank of Ghana (BoG) has been mandated to reduce the policy rate by 150 basis points to 14% and drop the regulatory reserve requirement from 10% to 8% to increase supply of credit to private sector. The Government is additionally looking to advance due dates for filling tax returns by corporations from the standard 4 months to 6 months after end of the basis year. Also grant tax waiver penalties owed by taxpayers who redeem their outstanding liabilities by 30th June 2020, waiver of VAT on donations needed for fighting the pandemic, and instituting an email filing and direct transfer payment system to allow taxpayers file and pay taxes with the various Ghana Revenue Authority (GRA) offices remotely.

## REFERENCES

1. Johanna Garnitz, Robert Lehmann & Klaus Wohlrabe (2019) *Forecasting GDP all over the world using leading indicators based on comprehensive survey data*, *Applied Economics*, 51:54, 5802-5816, DOI: 10.1080/00036846.2019.1624915.
2. Tao Wang (2016) *Forecast of Economic Growth by Time Series and Scenario Planning Method —A Case Study of Shenzhen* <http://dx.doi.org/10.4236/me.2016.72023>
3. Andrew Atkeson (2020) *What Will Be the Economic Impact of COVID-19 in the US? Rough Estimates of Disease Scenarios NBER Working Paper No. 26867*
4. Marco J. Lombardi, Philipp Maier (2011) *Forecasting Economic Growth In The Euro Area During The Great Moderation And The Great Recession ECB Working Paper Series No 1379*
5. Nicola M, Alsafi Z, Sohrabi C, et al. *The Socio-Economic Implications of the Coronavirus and COVID-19 Pandemic: A Review [published online ahead of print, 2020 Apr 16]. Int J Surg. 2020; S1743-9191(20)30316-2 doi:10.1016/j.ijssu.2020.04.018*
6. Warwick McKibbin† and Roshen Fernando‡(2020) *The Global Macroeconomic Impacts of COVID-19: Seven Scenarios\**
7. Victor Platon ,Andreea Constantinescu (2014) *Monte Carlo Method in Risk Analysis for Investment Projects* [https://doi.org/10.1016/S2212-5671\(14\)00463-8](https://doi.org/10.1016/S2212-5671(14)00463-8)
8. C. E. Onwukwe, G. O. Nwafor(2014) *A Multivariate Time Series Modeling of Major Economic Indicators in Nigeria American Journal of Applied Mathematics and Statistics DOI:10.12691/ajams-2-6-4*
9. Okoroafor, David O. K.; Adeniji, Sesan O.; Olasehinde, Timilehin (2018) *Estimating and forecasting the impact of inflation on economic growth in Nigeria using threshold analysis Journal of Applied Statistics*
10. Dr. Annie Uwimana, Dr. BI Xiuchun, Professor ZHANG Shuguang (2018); *Modeling and Forecasting Africas GDP with Time Series Models; International Journal of Scientific and Research Publication(IJSRP) 8(4) (ISSN: 2250-3153),DOI: http://dx.doi.org/10.29322/IJSRP.8.4.2018.p7608*
11. Bukvic, Ivana Bestvina (2019) *Significance of Monte Carlo simulation in prediction of Economic projections: A Critical review. International Scientific Conference on Economic and Social Development – Rabat, 21-22 March 2019*
12. Osés-Arranz, Ainhua and Quilis, Enrique M., *Probabilistic Population Projections Using Monte Carlo Methods: Spain, 2016-2066 (September 25, 2017). Available at SSRN: https://ssrn.com/abstract=3042472 or http://dx.doi.org/10.2139/ssrn.3042472*
13. Darko, Christian Kwasi (2015) : *Determinants of Economic Growth in Ghana, ZBW - Deutsche Zentralbibliothek für Wirtschaftswissenschaften, LeibnizInformationszentrum Wirtschaft, Kiel und Hamburg*
14. Lily, Jaratin, Kogid Mori, Mulok Dullah, Sang Liem Thien, and Rozilee Asid. 2014. *Exchange Rate Movement and Foreign Direct Investment in Asean. Economics Economics Research International 2014.*
15. Dimple Goyal and Ritu Jain (2014). *The Impact of FDI on Indian economy International Monthly Refereed Journal of Research in Management & Technology 88 ISSN – 2320-0073.*
16. Phillips, P. C. B., & Perron, P. (1988). *Testing for a unit root in time series regression. Biometrika, 75(2), 335-346. https://doi.org/10.1093/biomet/75.2.33*
17. Im, K. S ., Pesaran, M., & Shin, Y. (2003). *Testing for unit roots in heterogeneous panels. Journal of Econometrics, 115(1), 53-74. https://doi.org/10.1016/S0304-4076(03)00092-7*
18. Dickey, D. A., & Fuller, W. A. (1979). *Distribution of the Estimators for Autoregressive Time Series with a Unit Root. Journal of the American Statistical Association, 74 (366), 427-431. Https: //doi.org/ 10.2307/2286348*



## **JOURNALISTIC SKILLS IN MODERN JAPANESE RECREATIONAL TV SHOWS**

**Khalilova Aziza Shamuhutovna**

*Teacher, University of world economy and diplomacy  
Tashkent, Uzbekistan*

### **ABSTRACT**

*The globalization of society affects the national characteristics of the development of the media sphere, offering new models and the models for the existence of mass media. Especially the forms and functions of the media are changing. One of which is recreation. In all developed countries, recreation plays an even more important role, as the need for it increases in the increasingly stressful circumstances of life.*

*Enlightenment and recreation in Japanese journalism are reflected primarily in folklore, literature and the press, which embody the national spirit, universal and Japanese values. In particular, increasing spirituality, instilling national and universal ideas in the minds of the younger generation, reducing psychological stress, and exchanging positive mood - this is the essence of cultural, educational and entertainment functions in Japanese journalism.*

*This article discusses the essence and forms of the concept of "recreation" and its application, in particular in the media. It also deals with the various content programs, their classification and the skill of the presenters in the famous TV programs of the Japanese television.*

**KEYWORDS-** *Recreation, variety, Japan, TV shows, idol, journalistic skills, NHK.*

### **INTRODUCTION**

Informational and entertaining programs vary by content, theme, and presentation, making it difficult to compare with news-structured shows. Indeed, those programs include science, history, travel, music, documentaries, and the trend is becoming more widespread in the coming years. It is both difficult to create such kind of programs, and first of all to determine whether it is an informational, entertainment program. Due to this, the tendency to show informative, entertaining animations is that while there are a lot of images, there are not many scientific studies that are analyzed as exact numbers.

In prime time, which encourages a fierce struggle for ratings, it is important to keep the ratings of programs that have not been able to maintain a high position, as it is difficult to survive, especially for private and state-owned TV channels. In determining the specificity of recreational programs, NHK and private TV entertainment programs were selected as the object of study. As a result, prime time, which is the main "battlefield", was determined and an analysis of entertainment shows was conducted. Attempts were made to cover more demonstrations during the analysis.

In creating the hypothesis, first by watching the entertainment programs in private prime time, the specifics of the show elements were analyzed, such as studio, presenters, and based on this, the following hypothesis about the trends in Japanese television broadcasting was identified:

1. Variety of comprehensive animations;
2. The greater the number of shows easy to understand;
3. The number of programs aimed at attracting the attention of the audience using various recreational methods, resulting in an increase in the number of shows focusing on the process rather than quality;
4. The presenter's skills confirming these hypotheses, an attempt was made to analyze them on the basis of the following analysis subjects.

### **THE PRESENTER'S SKILLS**

The TV presenter has a number of professional skills and personal qualities. As th professional skills, we highlight the following:





1. Professionalism: The professional effectiveness of TV presenters depends in many ways on their level of qualification. The concept of professional qualification usually refers to the knowledge and skills that a specialist applies in practice.
2. Communicative: communication skills, the effectiveness of the telecommunication process depends on how well the presenters know and imagine the audience they are targeting.
3. Creativity: the ability to take a creative approach to any task;
4. Ability to work in a team: the process of transforming a show from an idea into a ready-made material for broadcasting is a common task of many qualified personnel. For this reason, the ability to exchange ideas and work collaboratively is an important skill.
5. Initiative: setting new tasks and carrying out professional tasks [2];
6. Broadness of the outlook;
7. Internal feeling: feeling the audience and the interlocutor;
8. Efforts: serious approach of the beginner to his work should be seen on the air;
9. Responsibility: the ability to be responsible for the reaction that their work, the product of their professional activities, evokes in the viewer. Knowledge and information serve as a strategic resource for the presenter, and every journalist must develop a sense of responsibility to use it wisely and conscientiously.
10. resistance to stress – the ability of a person to cope with stress, to ensure that it does not affect the quality of his professional activity, the ability to cope with various unexpected situations.

Effective use of the all genres requires the following knowledge and skills of the journalist:

- The psychology of the listener, his usual reaction, desire, system of values, the social and political environment that surrounds him;
- The country where the program is broadcasted, its history, literature, art, science, etc;
- topical issues and mood of the listener, the problems that concern him today;
- Internal and external issues covered by national journalists, method of statement, argumentation;
- The language (Materials intended for foreign audiences must be provided in the program-oriented state language) [4, 48].

Rules relating to the linguistic aspect of a beginner in a live broadcast:

- The style is important. If the listener does not understand a word, then he may not understand the whole sentence.
- Logical sequence in the text. The facts must be presented in a logical sequence.
- The language must be clear. The formation of two types of interpretation.
- The speech must be simple and fluent.
- A situation when a sentence can be full of some facts. The presenter's speech is his face.
- The name of the event in the important facts, the repetition of names [5, 67-68].

Giving the main genres of television, TV presenters can be conditionally divided into the following types:

The reporter-presenter: Sekai made itteQ (世界の果てまでイッテ Q!), the presenter of the show Mitsuyoshi Uchimura, Sekai fushigi hakken (世界ふしぎ発見) the presenter of the show Shinokhara Kaori (篠原), Khirata Kaoru (平田薫) the journalists leading the shows of these genres. In their work we can observe such skills as speed, mobility, flexibility, resistance to stress, reaction speed, ability to quickly move from one task to another, ingenuity, the ability to find interesting information unexpectedly, to have extensive information.

— Idol presenter: A representative of Japanese pop culture media with a young, beautiful, childhood innocent face. Usually most of them are singers, actors or actresses and their fan club has millions of fans. In order to take advantage of their achievements, various TV channels sign contracts with them and create special entertainment programs. As such programs, we can cite the program of Nippon Terebi TV channel with Arashi 「嵐にしやがれ」. The hosts of the talk show are members of the pop group "Arashi", each of which has its own role in the talk show.

— Showman-presenter: People who are famous in the world of show business, who have the ability to speak.

— Moderator-initiator: in our work we have the artistic ability of a beginner moderator, pleasant, high reaction rate, resourceful, unique appearance, bright individuality, easy to communicate with people who came to the studio to participate in the show, sincere, free, fluent speech, emotional, humorous, we can see TV presenters who can engage in lively games and conversations with viewers and show participants.

— Analyst-presenter: Ikegami Akira (Special Broadcast Leader Ikegami Akira has good knowledge and experience, a deep understanding of reality, the



ability to consider individual events in conjunction with other events, to understand their complexity and integrity, objectivity, different views and approaches. a beginner who can cover correctly, has a political culture and debate skills.

— Publicist presenter: it is impossible to imagine without a bright individuality, originality in the work, the ability to attract the attention of the audience and convince him of something.

— Interviewer (a person who leads an interview): must be communicative, attentive to the person, be able to speak, ask the right questions, direct the conversation in the right direction, be an interesting interlocutor.

— Robot presenter: on April 1, 2018, the android "AOI ERICA" joined Nippon TV as an announcer. According to Hiroyuki Fukuda, executive director of Nippon TV Broadcasting Network, the goal of the AOI ERICA project is not to create an "alternative" for humans, but to "expand" a creative product created in collaboration with humans and androids. [11]

In most Japanese shows, the program is lead in two tandems by female and male presenters, who reveal and comment on the essence of the events. Internet analysis is used to open the conversations in the studio and to clarify the environment. Although Internet analysis is used in the social, natural sciences, it has also recently been used by media researchers to study communicative communication between people on social media.

### **THE ANALYSIS OF RECREATIONAL PRESENTATION "SEKAI NO HATE MADE ITTE Q!"**

According to a 2017 survey by the Ministry of the Internal Affairs and the University of Tokyo, people under the age of 50 spend most of their time in front of the TV, with the highest viewing time after 8 pm on Sunday.

Nihon terebi private TV channel «Sekai no hate made itte Q!» (世界の果てまでイッテQ!) [9] the thematic idea of the program is related to travel. The show, which is broadcasted every Sunday at 7:58 p.m., is one of Japan's most popular recreational shows today. While the starter on the show travels to another country, it engages in challenging and dangerous activities in search of extraordinary things happening here.

But the reason most of these processes are based on laughter and humor which are of great interest to the audience.

The show was analyzed and the following conclusion was made:

1) the subject of the show is broad enough, and although the program is based on travel, in which

different activities are practiced, introduced to a different culture;

2) the image of the starter of the recreation, in which the starter's dress, facial make-up, style - all belong to the genre of light comedy;

3) the reflection of recreation in the skills of the leader, the ability of the leader to cover the process, in which the process is not limited to the activities of other participants, but to evoke excitement in the audience by experimenting in their own experience;

4) the presence of humor, sarcasm in the context of the show;

5) unrestricted movement of participants;

6) the presence of a clear motivation and voluntariness in the audience to see this show;

7) the desire of the audience to wait for the airtime, according to statistics, among the programs that will be broadcast on Sunday evening at 20:00 «**Sekai no hate made itte Q!**» The show ranks first in terms of audience share.

### **ANALYSIS OF IKEGAMI AKIRA'S (SPECIAL) BROADCAST**

**Name of the show:** Ikegami Akira's (special) broadcast [10].

**The type of the show and its aim:** Today, there are more than 110 recreational shows in Japan, including the Ikegami Akira's (Special) Broadcast, a recreational news program. Japanese recreational shows are mainly aimed at demonstrating various knowledge and innovations in the form of conversation, laughter, singing, games, quizzes, parodies, entertainment. It is known that most political programs are incomprehensible and uninteresting to the general public, which is why the audience of these programs is somehow limited. The purpose of Ikegami Akira's (special) broadcast is to rectify the situation, to raise public awareness, to warn, to focus on interesting political and social processes, to explain difficult issues in simple language and in an interesting way.

**General information about the show:** on October 20<sup>th</sup>, 2009, the first of show the program was transmitted. Initially, the programs were pre-recorded, but today the number of live broadcasts is growing. During the live broadcast, the word "special" will be added to the name of the show. The program was broadcasted on Fuji-Terebi channel from 2009 to 2016 from 21:00 to 23:00, and now from 20:00 to 22:00. According to the rating, it ranks 2<sup>nd</sup> among the best shows of the Fuji-terebe channel. The topics are mainly related to Japan (earthquake, economy, border issues), world religions and extremism, constitution, China, Korea, war, gender issues, military, nuclear threat, etc.



**The content of the show:** a total of seven people will take part in the show. Two presenters (Ikegami Akira, Sasaki Kyoko), three permanent participants, two invited guests and spectators from outside. There are two presenters on either side of the screen in the center of the stage. While the main facilitator covers the topic, her assistant begins the show, conveying the audience's opinion to the main facilitator by saying a question on the topic or occasionally making small conclusions. Regular attendees and guests sit behind a table set diagonally to the left of the stage. They are mostly people like actors and writers, sports commentators, famous statesmen. Their role in the show as a representative of the people is to ensure the liveliness of the show through their knowledge of the topic, assumptions, suspicions, and occasionally mixed with funny jokes. The main presenter, Ikegami Akira, communicates with them and explains in simple language the places they don't know and don't understand. In front of the stage, the audience take their seats.

**The meaning of the show:** The assistant presenter introduces the topic and asks the audience a clear question about current events in the world, with regular participants and guests answering the question through the media or as a representative of the people at their level of knowledge. He then hands over the correct, clear, and concise answer, the opening word, to Ikegami Akira to explain the content of the question. Ikegami Akira explains a particular event in an easy and simple way. Newspapers, magazines and programs on the subject will be published, and the information will be presented through the media, based on which the issue is covered step by step in an interactive way with the audience and guests about the origin of the issue, the current situation and possible changes in the future.

**The presenter's skills in the show, use of linguistic and paralinguistic methods, genre diversity:** The text of the information has an unconditional effect on the human mind, and is imprinted on the mind depending on its written, audio or visual form. The linguistic impacts performed skillfully by the presenter in this show:

- 1) the transfer of information from the general to the specific or from the specific to the general;
- 2) to avoid science and terminology in the speech of the presenter, to express the opinion in simple words;
- 3) consistent delivery of the basis and explanation of the thesis.

In addition to the linguistic effect of information, the paralinguistic effect is equally important. The fact that the show's presenters are female and male in a sense promotes the regulation

of reasoning. The female leader addresses the male leader with a question that is of interest to the audience, which in turn serves as the main argument for the male leader.

While the female presenter always directs the show using a series of questions, the male facilitator bases the ideas in response to it. The female presenter's voice is mild, evoking a sense of calm. Akira Ikegami, the presenter, on the other hand, causes a sense of confidence in the audience through the way she presents the information, the timbre of her voice, the fact that she confidently states the details, the ideas are well-founded, and also being an adult presenter.

The five invited guests, meanwhile, participate as a lyrical retreat, analyzing the place and role of the analyzed information based on their life experiences so that the audience is not bored with the topic.

Throughout the show, we can observe a variety of genres specific to talk shows. Genres of commentary, reportage, interview are widely used.

**Importance of the show:** in the existing political and social talk shows today, we can observe the imbalance of the elements of recreation. The shows are classified as serious, spiritual-enlightenment, or super-entertaining programs. The audience for serious political programs is not wide, and mostly entertainment programs dominate.

In short, along with technical capabilities, beginner skills play an important role in the creation and popularity of a show. Each of the above skills requires a combination of certain qualities, the beginner must work tirelessly on himself, develop professional skills, as well as strive for spiritual maturity.

## THE CONCLUSION

— It is important to note that the programs broadcasted and analyzed on Japanese TV screen from 19:00 to 22:00 consist of analytical recreational, political, recreational commentary and recreational cultural-educational programs. Analysis of political shows reveal that recreation is widely used not only in entertainment shows, but also in political and social shows. It is used for the purpose of relieving political pressure, easing the situation, if it is a conversation with famous politicians, supporting the interlocutor through a humorous assessment of the situation, helping him to enter the conversation.

— There are 5 criteria governing recreational broadcasting and the broadcasting set by the standards set by the Japanese national radio and television. According to research, it is one of the Japanese TV channels 「バラエティ」 – «varity» entertainment programs were found to have 11 different classifications.



— extensive, large number of light performances in modern Japanese “baraits” through the analysis of Japanese entertainment shows; As a result of the large number of attention-grabbing programs, there is a tendency to focus on the process rather than quality, and to capture the audience by creating a friendly environment.

—Taking into account the main genres of television, the activities of TV presenters in Japanese television were analyzed and the following types of presenters were identified: reporter-presenter, idol-presenter, showman-presenter, analyst-presenter, publicist-presenter, interviewer, robotic presenter. Idol presenter and robot presenter are relatively new trends observed in Japanese television activities, and their specific aspects have been analyzed and studied.

## REFERENCES

1. *Broadcasting Act Law (放送法) number: Act No.132 of May 2, 1950.*
2. *Boretzkiy R., Kuznetsov G. TV journalist in the picture and behind the picture – Moscow, 1990*
3. *Domestic program standards (国内番組基準), 21.06.1959, 26.09.1995-26.05.1998. revised edition*
4. *Ismailova K. International broadcasting, - T.: UWED, 2006.*
5. *Ismailova K. In live mode, - T.: International Center for the Retraining of Journalists, 2007.*
6. *Personal Information Protection Law (個人情報保護法). – Japan, 2003.*
7. *Positioning of variety programs in TV program// テレビ番組におけるバラエティ番組の位置づけ・鹿島我 /Kyoto Koka women's University/NII Electronic library service.*
8. *Youth Protection Law (青少年の保護に関する法律). – Japan, July 16, 2003.*
9. <https://sirabee.com/2018/05/14/20161617207/>
10. [https://www.fujitv.co.jp/ikegamiakira\\_sp/](https://www.fujitv.co.jp/ikegamiakira_sp/)
11. <https://www.eric-android.jp/>





# IMPORTANCE OF ATTENTION IN PRESCHOOLERS' COGNITIVE DEVELOPMENT TO PROGRESS ACADEMIC PERFORMANCE

**Iminova Xumora Mukhammadisa kizi**

*Student of Russian language and literature, Fergana state university*

## ABSTRACT

*It is important to note that the importance of article recognition is crucial for child development, and important aspects of the child's academic learning. Additionally, attention is given to the three-dimensional features and further recommendations are given.*

**KEY WORDS:** *attention, child development, optional attention, careful attention, academic performance*

## INTRODUCTION

Attention is an active focus of the mind, and the basis of the cognitive processes, without which knowledge cannot be effected efficiently. This will only be noticeable if we focus on the processes that take place in every process of learning. The well-developed development of the child has led to the successful outcome of each study process. The period of active organization and development is 5-6 years of age. This age is in the early childhood and the development of focus affects the academic development of the child. These age-old attributes of the children are shaped, but they are evident by circumstances. During this period, the child can move one object from one object to another. Attention is not studied in a foreign policy as a whole. Actually? Attention is a psychic process? Attention is the underlying psychic process that serves as a basis for the realization of these psychic processes. Attention can also be seen as a psychological process because it has its own function. Even though this process may remain in others, it is clearly visible. Attention must be paid to the realization of each psychic process. For example, a young man is singing loudly before you go to the street. If you did not pay attention to her, the sense of hearing would not work. You could not even hear the sound. In this example, you can see a single click.

## THREE LEVEL OF ATTENTION

Attention - determines the activity of a person and his / her choice of objects and phenomena in the object. The focus is on the psyche of the psyche. If you are not careful, there will be no real-

life activity. Careful attention is given to specific situations and situations. Taking into account such a situation ensures that the activities carried out by the human beings are conscious and that they are productive. The solution of any matter and every vital task requires that the person concentrate on the content of this issue and the methods of action to be taken. Therefore, carefulness varies considerably from all other psychic processes. Its peculiarity is that it is not an independent form of psychic activity, like the form of expression, but rather the organized activity of other psychic processes.

Attention is one of the most important conditions for successful implementation of all types of human activities and their effectiveness. Human intelligence, sophistication, quick clarity, curiosity, and cordiality serve as an important factor in his or her lifestyle and interpersonal relationship. Attention is involved in all forms of mental activity, and the actions of a person occur in his presence. It should be noted that attention is not a separate psychic process, such as perception, perception, memory, thinking, fantasy, speech. *Attention is involved in all the psychic processes that have an impact on increasing their productivity.* Therefore, attention-focused objects are clearly and clearly reflected in the point at which accumulated consciousness is accumulated. Hence, attention is a person's inner activity that provides the quality, productivity and effectiveness of mental processes. It is also a necessary condition for any human activity.

Psychology can be divided into the following types by focus:





- external attention;
- internal attention.

At the same time, depending on the type of activity:

- individual
- team types

#### Outdoor attention.

It is said that our minds are focused on things and phenomena in the objective vocabulary, some of their features and attributes, and that they are actively assembled. External attention is not only apparent in the perception process, but also to the things that are being considered. It is an example of how the inventor can imagine what he has created, the process of discovering the artist's images, and bringing the engineer's dam construction to the forefront.

### INTERNAL ATTENTION

Is to focus our mind on our subjective impressions, feelings, and aspirations. In contrast with external attention to the observation of the emotions, thoughts, desires, desires and the like that occur in the human mind, both the emphasis is on making a worthy contribution to the successful completion of the activity, has the potential for tumors. A person can be directed to a particular object and accumulated it *individual*; the consciousness of a group of people or a group of people depends on the direction and objection of the mental activity to one object *group* or *team attention* is referred to as.

Depending on the nature and way of making:

- If you wish (slow) - the purpose of the person does not participate in its appearance;
- Voluntary (active) - it is because of the intention of a person to use his will power.
- voluntary ending.

If you want to focus attention is the low form of attention, usually due to the influence of the stimulus on any of the analyzer. It appears according to the targeted reflex laws and is general for humans and animals. It may be because of the stimulating stimulus and these adversaries as they are due to their previous experience or mental condition. Only voluntary personal attention that is shaped in the teaching and learning process is more complicated. Its characteristic feature is that it passes through the intention and purpose of the object. It can also draw attention to the needs, needs, changes in the body, such as thirst, pain, and headache. The nervous-physiological basis of the emphasis is the orientation or targeted reflex. For instance, a slight change in the environment around us causes immediate targeted

reflexes. In other words, we begin to look around in the meaning of what is meant. Interesting novels, movies, and interesting conversations attract our attention. That's why we also called this emotional emphasis. There are three types of emphasis that are voluntary, optional, and optionally divided into types of care. First of all, there is a type of care that will help the child to know the outside world and will not waste any effort. More precisely, this kind of attention begins from the very first days after birth. This kind of emphasis on the emotional aspect of a human being does not require excessive energy and does not cause any unplanned targeting. It is also possible to say that human emotions are lying. For example, when you open the door suddenly when a child is playing in a quiet room, he looks for you. The sound of the door sounds to the point of focus. If the child's attention was poor, the child would not hear the doorbell. Always our sensory receptors come to the analyzer to deliver the information, but without the careful process, the brain does not accept this information. Even though there are many people on the street, you will only remember someone who looks or appreciates you. Keeping that person in memory is inevitable, because if you do, the focus will be activated. In fact, you do not plan to remember that person, but his crimson shirt has attracted your attention.

Voluntary attention is a focused focus. This kind of emphasis implies compulsion to concentrate on consciousness. The psychological trait of voluntary attention is that it is accompanied by a lot of effort and persistence, with long-term survival of the volunteer attention, which is often caused by fatigue rather than physical exertion. Therefore, volunteer attention should not be excessive during training.

In psychology the optional type of attention is often called irony. This is definitely not in vain, because the emphasis on focusing on a certain object is maintained by willpower. Even if you are interested in attending attention, it is also concentrated on the object of willpower. However, voluntary attention can arise if you focus.

The last focus on volunteerism is the focus of attention on a specific subject, and then its significance is understood as the concept of self-censorship (automated), which is embodied in psychology by psychologist N.F. Dobrinin.

Voluntary attention is drawn to an object with a long-term focus and no significant effort can be made. The high, effective, and productive performance of all types of work depends on this type of focus. The concentration and concentration of attention in the object depends on the person's interest. Even if you want, attention and interest are of great importance when engaging in attention. Typically, interest in



activity is expressed directly and indirectly. Direct interest is of interest to the business process, to the behavior itself, to the methods of work. Indirect interest is the activity focused on the purpose and the outcome.

## DEVELOPING OF CHILDREN ATTENTION

In the last years of pre-school age, the child is educated as a preschool. Now, a new activity type reading activity comes into play. If the child has been actively involved in the game activity, now it is necessary to form voluntary and voluntary types of care for the educational activities. But the child is tired of being voluntarily disturbed by the need for voluntary effort. All the child's activities and mental activity are directly related to this type of attention. It is difficult for the child to focus on the child's attention due to the fact that the child is attractive. When new information is being learned by the educator, attention children cannot retain information as other partners. Because, unless emphasized the data is not stored in memory. As a result, the child's appetite will remain behind. Formulation of a post-voluntary focus for the child to prepare for academic study has a positive impact on the development of the child. At first, children volunteer their attention so that they can master some knowledge, and then they gradually focus on the voluntary attention as the importance of the information becomes clearer. That's why we can call it automated attention. This emphasis should be on the active consciousness of the mind, and automatically comes to an unexpected point by automatically understanding the true nature of the information. The focus narrows down and any data that you receive is stored in memory. For example, it is difficult for the child to miss new words, since the child's attention to the English language is fluent in English teach educators to sit tightly and patiently to hear the lesson and master the information with optional attention, we can keep the child's attention up to 6-8 minutes. However, this voluntary type of care can be further enhanced by the post-volunteer attraction. In the learning process, children will be encouraged to improve their academic skills by focusing their attention on volunteers and this type of attention does not require irritation.

Post-volunteering methods:

- Making the received information as interesting as possible
- The use of child-focused objects also helps to get the information
- Provide the information provided to the child's emotions
- Practice the information provided

- Helping the child to understand the information that is being taught.
- Promoting the child's knowledge
- Providing adequate motivation for the child
- It is important to take a brief break in the child's concentration time when dealing with the child
- Focus on ways to achieve goals

## CONCLUSION

In summary, it is based on every psychic process. The focus of the learning process is to work more effectively when it is active. Developing an attractive type of attention can help us to increase our child's academic abilities. One of the most challenging issues is to draw a child's attention. Because of the severe deficiency syndrome in children. If the child's attention is not met, his academic abilities will remain behind. To prevent it, teachers and educators need to use creativity. Because, it requires conscious work from a person to concentrate focus on an object or event. We cannot demand targeted care for a child who is not yet fully aware of his / her conscious work. He is not well developed to understand this situation. Therefore, every person involved in child rearing should be creative in his work. The information should, as much as possible, affect the child's emotions and attracts attention.

## REFERENCES

1. E.G'oziyev. *Umumiy psixologiya. – Toshkent, O'zbekiston faylasuflar ilmiy jamiyati nashriyoti, 2010.*
2. B. Lefa. *The Piaget theory of cognitive development: an educational implications.– USA, Iowa: Wadsworth, 2009, 456p.*
3. J. Sternberg. *Cognitive psychology, sixth edition. – USA, Belmont: Wadsworth, 2012, 643p.*
4. M.T. Isaqova. *Etnopsixologiya.–Toshkent: Iqbol-Turon, 2007, 105p.*
5. Okely T., Howard S., Cliff D., Reilly J., Jones R., Janssen X. *Relationships between standing and stepping time and executive functions in children aged 3–5 years. J. Sci. Med. Sport. 2014;18:e39. doi: 10.1016/j.jsams.2014.11.231. [CrossRef][Google Scholar]*
6. R. Shaffer and K. Kipp. *Development psychology Childhood and Adolescence, eight editions. – USA, Belmont: Wadsworth, 2010, P. 57-59.*



# THE BEGINNING OF THE EUROPEAN RENAISSANCE

**Mahmudov Otabek**

*Doctor of philosophy (PhD), Head of Department of World History of Fergana State University, Republic of Uzbekistan*

Article DOI: <https://doi.org/10.36713/epra4787>

## ABSTRACT

*In article on the basis of careful analysis of the scientific literature devoted to history of the translations in Spain in XII–XIII centuries, the place of the Toledo school in the formation of the Renaissance process in Europe is revealed. In addition, the historical significance of this school in the translation and study of the works of scholars of the medieval Muslim East is assessed. As a result of the analysis of political, social and cultural processes that took place in the VIII–XII centuries on the Iberian Peninsula, the historical factors that influenced the formation of the Toledo school are established, and it is also proved that the period of mutual synthesis of East and West cultures was the main historical factor in the formation of the school. The scientific and methodological foundations of views on the stages of the Toledo school's activity, the staff, tasks, as well as translators and scientists who worked at the school are revealed. based on this, it is proved that the Toledo school is the logical beginning of the Renaissance of the West.*

**KEYWORDS:** Toledo school, Renaissance, Spain, Europe, Muslim East, Middle Ages, Arab, Castilian, Latin, translations, translators.

## 1. INTRODUCTION

In a number of countries around the world, special attention is paid to translation activities carried out in cities of Spain, such as Toledo, Saragossa, Segovia, Navarre, Seville and Barcelona in the XII–XIII centuries. Among these centers, the role of the Toledo school in the history of science is considered very important, as a result, research is conducted in priority areas of this subject. Despite this, questions about the creation of the school, its composition, translation works, scientific activities in the school, the life and work of translators and scientists have not yet been fully studied in its entirety.

**1.1. Literatures review.** The scientific research of foreign scientists M-T. de Alverny [1], J.Gil [8], S.Hayyek [10], C.Burnett [2], R.Henelde Abecasis [11], K.Foz [5], M.Gargagliati [6], M.Robinson [19] and A.Fidora [4] are the most important works on the study of problems related to

the Toledo school. They scientifically analyze the issues of formation and activity of the school.

To date, the history of science that developed in Europe in the XII–XIII centuries. Studied by scientists in the region. In this regard, the translation activity of that time was not left out of the attention of researchers. The works of F.Carmody [3], C.Haskins [9], L.Thorndike [20] and E.Grant [7] are considered major studies in this field.

Despite this, the lack of fundamental work in this direction requires a deep scientific research, covering in a comprehensive way the problems related to the creation of the Toledo school, the composition, tasks, life and work of translators, translation and scientific activities, as well as research works of scholars of the Muslim East in the school.

I have also been conducting scientific research in this area for several years [12, 13, 14, 15, 16, 17, 18]. As a result of this research, in 2018 defended my doctoral dissertation on the topic “The



place of the Toledo School in the study of the scientific heritage of Central Asian scientists in Europe (XII – XIII centuries)”. Today, continuing its scientific research expanded the geography of its research. Now, my dissertation for the degree of doctor of science (DSc) is called “Studying the scientific heritage of Eastern scientists in the translation centers of medieval Europe”. This article is another result of my research on the topic.

**1.2. Objective.** The objective of the study is to reveal the place of the Toledo school in the formation of the Renaissance process in Europe. In addition, assess the historical significance of this school in the translation and study of the works of scholars of the medieval Muslim East.

## 2. MATERIAL AND METHODS

**2.1. “The historical roots of the Toledo school: factors that contributed to its formation”.** This section analyzes the political, social and cultural processes that occurred in the city of Toledo from ancient times to the XII century, that is, during the Roman Empire (193 BC – 411), the Alans (411–469), the Kingdom of the Visigoths (469–712), the Arab Caliphate (712–756), the Emirate of Cordoba and the Caliphate (756–929–1031), as well as the Emirate of Toledo (1031–1085), and describes individual factors that became the basis of the to form a school. The result of the analysis is that Toledo, located in the very center of the Iberian Peninsula, has been the basis of numerous civilizations since ancient times. The main factor is that due to its convenient geographical location, the city has always been considered the most important strategic center.

As one of the historical factors that directly influenced the formation of the Toledo school, we can point to the development of scientific processes that occurred during the reign of the Emir of Toledo, Yahya al-Ma'mun (1043-1075). Al-Ma'mun, paying special attention to attracting major scientists to his Palace, tried to create the necessary conditions for them. In particular, scientists who came from different parts of the Iberian Peninsula worked in his Palace, such as doctors: al-Wafid, Ibn Walif, al-Lukuh; astronomers az-Zarkali, Ibn Assafor, as-Sahli; mathematics – al-Waccadi, at-Tujibi, Ibn al-Attar, Ibn Khamis, Ibn al-Binus, geographer and engineer Ibn Bassal and historian Sayid at-Tolitoli. The paper pays special attention to the life and work of the above-mentioned scientists. An important aspect is that the scientific legacy left by them later contributed to the formation of the Toledo school and as a “local source” assisted the research of scientists who worked there [12. p. 24].

The work that served as the most important factor for the formation of the Toledo school was

carried out by the king of Leon and Castile, Alphonse VI (1069-1109), who in 1085, having restored Christian power in Toledo, made it the capital of his state. It is known that a large library was established in Cordoba by Caliph Abdurahman III (912-962). The real library during the reign of his son al-Hakam II (961-976) became even richer, and the number of books reached more than 400 thousand. During the offensive of Alphonse VI in Cordova, he took possession of the remaining part of the books, took them to Toledo as a trophy. The king, in order to preserve these manuscripts, gave instructions to place them in the Cathedral Church. The above works were translated into Latin by translators of the Toledo school from the beginning of the twelfth century. At the same time, it should be noted that at one time, by order of Abdurakhman III, the first European paper production workshops were established in Toledo. As a result, the city becomes a major paper producer in the region. The rich experience of the Toledo masters accumulated in this industry subsequently ensured that paper needs were met in a timely manner during the period of extensive development of manuscript copying and translation work.

Another aspect that became the basis for the formation of the school in Toledo was the mutual mixing of the cultures of the East and West in the VIII-XII centuries, that is, the period of synthesis that occurred. This process has become not only a period of mutual enrichment of cultures of different peoples, but also a period of formation of a society with a new mindset. The transformation of Toledo into a scientific center where representatives of three religions worked together side by side: Muslims, Christians, and Jews, prompted scientists from all countries and cities in the region to create in this place. As a result, in the XII-XIII centuries, the ground was prepared for the formation of the Toledo school – a “transit point” that transmitted the achievements of science from the East to the West.

**2.2. “Stages of activity, composition and tasks of the Toledo school”.** Exact information about the year of establishment of the Toledo school is still unknown. And the term “Toledo school” was first used by historians of the last century in order to generalize the activities of a team of translators who were engaged in creative work in the city of Toledo in the XII-XIII centuries.

Based on the results of analysis of the data obtained in the course of the study, we came to the conclusion that the formation and activities of the school should be divided into 3 stages.

Stage I – covers the years 1125-1152, that is, the period when a man named Raimondo de Salveta worked as Archbishop of the city of Toledo. It was on his initiative that a special group of translators was formed to translate works in Arabic that were





located in the Cathedral Church. This leads to the conclusion that Raimondo played a major role in the formation of the school. During the above period, works related to astrology, astronomy, and mathematics were mostly translated. During this period, by order of Raimondo, in order to create favorable conditions for members of the school, the Cathedral Church of Toledo was restored again and additional special rooms were built for translating and writing works [17. p. 5-8].

In the second stage – the joint activity of translators in pairs deserves attention. During this period, translations of philosophical and medical works were created. Also, translations of individual works related to natural and exact Sciences are processed. At this stage, which covers the period from 1152 to the second half of the XIII century, translation work turns into a well-organized permanent activity. Based on the created conditions for translation activities and the centralized mode of work, this period can be called as a fully formed period of the Toledo school. During this period, the organizational services of the archbishops of Toledo, John Castellmorona (1152-1166) and Rodrigo Jimenez de Rada (1202-1247) were great [18. p. 14-20].

Stage III – coincides with the period of the reign of King Alphonse X of Castile, i.e. 1252-1284 years. According to reports, Alphonse X, along with overseeing the school's activities, personally edited the newly created individual translations. During this period, certain works translated into Latin in previous periods began to be translated into Spanish of the Castilian dialect, in connection with the Declaration of it as the state language. Along with exact and natural Sciences, translation of works related to literature, editing of translations by a special proofreader is considered a special peculiarity of this period. Despite this, during this period, the circle of activity of the Toledo school is narrowing, in a certain sense, its former glory is decreasing. The reason for this was that the king paid great attention and time to the newly created scientific and cultural center – in Seville [16. p. 3-7].

The school's location took over the library and the special offices of the Cathedral Church adjacent to it. Special-service rooms were built on the initiative of Raymond, John and Rodrigo in different years, based on the need. The above premises consisted of parts intended for translators, copyists, bookbinders, they were equipped based on their needs. Apparently, there were additional rooms that are adapted for other processes related to the conduct of scientific discussions and writing of books. They are an integral part of the school.

The school operated under the personal guidance and patronage of archbishops Raimondo,

John, Rodrigo, and King Alphonse X. This is confirmed by their personal management of the work related to the selection of a work for translation, the appointment of a translator responsible for the translation, as well as financial support. It is this aspect that means that the above-mentioned persons were at one time the highest leaders of the Toledo school. In the school, after the top Manager, there was a position responsible for the day-to-day activities of the institution. The famous translator Domingo Gundisalvo is the first person appointed to this position of “head of records management” [13. p. 3-7].

Another position of the school was called “eméndador” (“spotter”) it was introduced at the initiative of Alphonse X in the second half of the XIII century. The person holding this position performed editorial editing of the created translations. The next responsible person in the school was the “magister” (“master”), the persons with this status at the same time consisted of three or four people and they led the activities in a certain direction. At the Toledo school, in addition to the heads of responsible managers, scientists and translators, a group of employees performed practical work such as copying, providing services to readers, master bookbinders and delivering translated works to their customers.

One of the original tasks of the Toledo school was to collect various works in Arabic, store and provide services to readers. As a result of the need to find out the content of books, his main task was formed – translation. Many members of the school were not only simple translators, but also major scientists in their field [15. p. 534-536]. They, in addition to translation work, undertake the research directly studying the works of the Arabic language. This means that over time, the school's tasks have expanded to include responsibility for research. In some studies, it is noted that the school held classes in Arabic and astrology, this information might contribute to the basis to claim that the tasks of the Toledo school included teaching.

### **2.3. “Translators of the Toledo school and their activities”.**

The main group of translators who carried out their activities at the school consisted of people from different countries of Europe. Of these, the Spaniards – John of Seville, Domingo Gundisalvo, John of Spain, Mark of Toledo, Alvaro de Oviedo; the English – Adelard of Bath, Alfred of Sareshel and Michael Scot; the Italians – Gerard of Cremona, Herman of Germany; the Jews – Ibn Daud, Ya'ud Ibn Moshe Cohen, Ishaq Ibn Sid, Abraham de Toledo, Samuel de Toledo; the Flemish – Rudolf of Bruges. In addition to them, commissioners and members of the school supported the collaborative relationships with translators living in other cities.





Also, financial support and encouragement of the creativity of these translators in many cases was provided by the school's management. Avraham bar-Hia, who lived in Barcelona, and Plato of Tivoli; Pedro Alfonso, who lived in Saragossa, Herman of Dalmatia, and Hugo of Santali; Robert of Chester, who lived in Segovia; and Robert of Ketton, who lived in Navarre, were among the school's collaborators.

Many of them were not only simple translators, but also outstanding experts in their profession. The above-mentioned scientists together with the implementation of translation activities, having studied directly the works in Arabic, wrote their books on the basis of them. Proof of this can be given in the example of written works, called *lat. "Regulae abaci"* ("Work in the abacus") by Adelard of Bath, related to the science of calculus, "*Liber de Judiciis Astrologiae*" ("Book of astrology reflection") by John of Seville, referring to astronomy, "*al-Aqidah ar-raffiyah*" ("the Great faith") by Ibn Daud, referring to philosophy, "*Liber introductorius*" ("Book of introduction") by M. Scot, which has an encyclopedic character.

Brief conclusion in this direction is the fact that as a result of their work numerous valuable books, belonging to Peru stars of science the ancient period and the great thinkers of the East, were translated into Latin and Castilian Spanish, as well as scientific theories in them have become a spiritual treasure of all the peoples of the European region.

**2.4. "Translations made at the Toledo school and their significance"**. The process of translation school of Toledo was carried out in a more complex system, over time this system changed, evolved. Initially, works in Arabic were translated first into the local Castilian or Hebrew languages, only later translated into Latin. More precisely, a person who knows Arabic, the translation of the work was transmitted orally in the local Castilian or Hebrew language to his partner, who knows Latin, the second person, in turn, translated everything he heard in writing into Latin. The reason for this process was the ignorance of some translators of the Arabic language, and others of the Latin language. Based on this, if you look at the activities of the school from this point of view, you can see that in many cases their members carried out their activities together. In some cases, this method has caused the creation of works with various errors, which were translated from works with different levels of complexity. Therefore, some translations of the works were later corrected.

If you pay attention, among the representatives of the school were translators who have the ability to translate directly into Latin. For example, Adelard of Bath, John of Seville, Gerard of

Cremona, Michel Scott, Mark of Toledo and Herman of German are among them. Of these, the translations of Gerard, Michael, Mark, and Herman are distinguished by their scientific excellence. In addition, John of Seville, in certain works that he translated into Latin, deliberately did not translate geographical information and information related to the Islamic religion. He translated only the main idea of individual works. Of course, this "method" has had a significant negative impact on the scientific level of the work. This "method" is also inherent in the work of Adelard of Bath.

### 3. RESULTS

If you look at the list of works that were translated into Latin at the school of Toledo in the XII-XIII centuries, you can see that in the first time a lot of attention was paid to the translation of works related to such fields of science as astrology, astronomy, mathematics and medicine. Subsequently, in particular from the second half of the XII century, translations into Latin of works related to philosophy became widespread. Since the second half of the 13th century, examples of fiction have been included in the list of these works.

The total number of works that have been translated is 98 works, they belong to the pen of 43 authors, including 11 of the ancient period, 32 scholars of the East of the middle ages. 49 works are related to exact Sciences, 25-natural Sciences, 24-Humanities. It should be noted that this information is another result of our research on the topic. Based on this, the further increase in the number of works that were translated at the Toledo school and the expansion of the list of their authors in the course of our subsequent research is natural [14. p. 5-20].

### 4. CONCLUSIONS

The Foundation of the Toledo school was created during the Raimondo period. In particular, on his initiative and patronage, numerous translators from different parts of the region gathered here and launched the center's activities. And through the efforts of John and Rodrigo, various forms of assistance were provided, as a result, the activities of the center expanded much and rose to a new stage. This is what ensured the transformation of this place into a scientific school of its time. In the era of Alphonse X, although the scope of the school's activities narrowed, its former glory in a certain sense decreased, but at the same time, a number of reforms were implemented in the field of translation, which, in turn, played an important role in the formation of translation theory in Europe.

The Toledo school, which first appeared as a place of storage and collection of various rare works in Arabic, then turned into a place of their translation



and launch into circulation, in a short time became a scientific center for exchanging the experience of scientists of different nationalities, conducting discussions, writing research on the Sciences of that time.

As a result of the effective work of a whole group of translators who were engaged in creative work at the school, more than 120 books in Arabic belonging to different peoples, nationalities, faith and culture, concerning astronomy, mathematics, philosophy, medicine, geography, chemistry, biology, history, literature were translated into Latin. At the same time, the above-mentioned works became the intellectual property of the entire Western world and occupied an important place in the development of various branches of science in the region.

### REFERENCES

1. Alverny, M-T d'. (1982). "Translations and translators". *Renaissance and Renewal in the Twelfth Century*. p.p: 421-462.
2. Burnett, Ch. (2001). "The Coherence of the Arabic-Latin Translation Program in Toledo in the Twelfth Century". *Science in Context*. (14). p.p: 249-288.
3. Carmody, F.J. (1956). "Arabic Astronomical and Astrological Sciences in Latin Translation: A Critical Bibliography". Berkeley. California University Press. p.p: 193.
4. Fidora, A. (2010). "La Escuela de Traductores". *La Catedral Primada de Toledo, dieciocho siglos de Historia*. p.p: 480-483.
5. Foz, C. (1999). "Bibliografía sobre la escuela de traductores de Toledo". *Quaderns: revista de traducción*.(4). p.p: 85-91.
6. Gargagliati, M. (1999). "La historia de la escuela de traductores de Toledo". *Quaderns*. 1999. (4). p.p: 9-13.
7. Grant, E.A. (1974). "Source Book in Medieval Science". Cambridge. Harvard University Press. p.p: 587.
8. Gil, J. (1990). "The Translators of the Period of Don Raimundo: Their Personalities and Translations (1125-1187)". *Rencontres de cultures dans la philosophie medievale. Traductions et traducteurs de Antiquite tardive au XIVe siecle*. p.p: 109-119.
9. Haskins, C.H. (1957). "The Renaissance of the Twelfth Century". Cambridge. Harvard University Press. p.p: 437.
10. Hayyek, S. (1990). "Escuela de Traductores. Toledo despensa cultural de Occidente". *Islam Español*. p.p: 219-220.
11. Henelde Abecasis, R. (1998). "Escuela de Traductores de Toledo Pasado y presente". *Raíces, Revista judía de cultura*. (35). p.p: 28-41.
12. Makhmudov, O.V. (2017). "The Toledo School – early center of investigation of the works Central Asian scholars in the Europe". Saarbrucken (Germany): Lambert Academic Publishing. p. 193. ISBN: 978-3-330-33405-2.
13. Makhmudov, O.V. (2017). "Some reasons about employees of the translator Domingo Gundisalvo in Toledo School". *Austrian Journal of Humanities and Social Sciences*. (1-2). p.p: 3-7.
14. Makhmudov, O.V. (2017). "Translations carried out in the Spanish translation centers (On basis of the works of scientists of antiquity and Muslim East)". *Asian Journal of Multidimensional Research (AJMR)*. (6-2). p.p: 5-20.
15. Makhmudov, O. (2017). "Latin translations of the works Abū Bakr ar-Rāzī and their values in development of the modern sciences". *History, Problems and Prospects of Development of Modern Civilization*. (18). p.p: 534-538.
16. Makhmudov, O.V. (2017). "Toledo School in the period of King Alfonso X". *Proceedings of the 1st International Conference on History, Sociology and Philosophy*. (1). p.p: 3-7.
17. Махмудов, О.В. (2017). "Феномен Толедской школы и три этапа переводов". *Евразийский Союз Ученых*. (12-1 (45)). 5-9 [Makhmudov, O.V. (2017). "The phenomenon of the Toledo school and the three stages of translation". *Eurasian Union of Scientists*. (12-1 (45)). p.p: 5-9 (in Russ)].
18. Махмудов, О.В. (2017). "Феномен Толедской школы и четыре этапа переводов". *Всеобщая история*. (3). 14-21 [Makhmudov, O.V. (2017). "The phenomenon of the Toledo school and the four stages of translation". *General History*. (3). p.p: 14-21. (in Russ)].
19. Robinson, M. (2007). "The Heritage of Medieval errors in the Latin Manuscripts of Johannes Hispalensis (John of Seville)". *Al-Qantara*. (28 (1)). p.p: 41-71.
20. Thorndike, L.A. (1964). "History of magic and experimental Science". New York. Columbia University Press. p.p: 835.



## **SUBJECT OF INNOVATION ACTIVITY – DEFINING ELEMENT OF MODERNIZATION OF THE SOCIETY**

**Khakimov Erkin Tuychiyevich**

*Candidate of philosophical sciences, Dotsent Ferghana State University.*

*Fergana, Uzbekistan.*

### **ANNOTATION**

*The article analyses issues related to the role of innovators in the dynamic development of society, factors contributing to the modernization of the economy, taking into account international experience. The issues of the interdependence of the level and quality of education of the countries population and economic growth are concerned. The article also talks about the characteristics of innovators and the problems that may arise in the transition to an innovative economy.*

**KEY WORDS:** *innovator, “knowledge economy”, modernization of an economy, factors of modernization, education and economy, features and abilities of creators.*

### **DISCUSSION**

Gaining of independence put many different on scale and charter problems, which Uzbekistan should solve. Main of them – creation worthy condition for citizens' life activity and integration to the world economic and humanitarian area. It is necessary to solve many tasks for gaining these purposes. The most important of them are realization principles of “knowledge economy”, as necessary condition of integration to world economics, in order to get worthy place there. The efforts of political leadership, intellectual and business elite of the country in cooperation with international organizations led to desirable practical results - in the public mind positive attitude towards reforms has formed, recognized their moral legitimacy, the population ceases to nostalgia a guaranteed minimum in condition of former system, directing efforts to achieve success in the new socio-economic realities. In XXI Century, a special role among strategically important problems in different countries belongs to innovations and an innovative economy. This is the main direction of modernization of society. [1.5].

Sustainable development of European Union, Japan, South Korea, Malaysia, China and others was reached due to expansion of innovative processes in real sector of the economy. Over the past 30 years the number of people employed in

innovative sphere in Western Europe has increased by 2 times, and in Southeast Asia – by 4 times. Share of innovatively active EU countries is more than 56 percent. In developed countries 75 percent of GDP growth is provided by innovative technologies. It should be noted the characteristic key feathers of an innovation-based economy. According to the most experts, three the driving forces of the modern economy are:

1. Knowledge as intellectual capital and in this sense as a strategic factor
2. Changes, both constant and fast and complex, generating uncertainty and reducing predictability.
3. Irreversible globalization in technology, production, trade, finance, communication and information, which result in open economies, global hypercompetition and interdependence in the business sector.

Another major condition for the development of the innovative economy as the basis for modernization of society is integration of vocational education, science and production. In turn, in all these areas, the most important role belongs to the subject of innovation, that is, to a person who has the appropriate knowledge, skills, abilities, etc. Therefore, the statement is true that in the conditions



of an innovative economy, a person acts as goal and means of innovative activity, and investment in human capital, in the development of his creative potential is a necessary condition for reforming and updating society. The fact is that at the present stage, material factors of production more and more often cease to be the main ones since they become outdated every five to ten years. Under these conditions, the main factor in production and its effectiveness becomes a person – a professional with his creative potential and investing in the training of such a specialist is one the most profitable areas of investment policy.

The course of the global economy shows that of the 150 countries that have embarked on the path of market transformation and the development of innovation, only no more than 15 can claim to be developed. Only 7-8 countries can be classified as highly developed, they hold the leadership in 50 macro-technologies, they account for 92% of the world volume of high-tech products (US share - 39%, Japan - 30%, Germany - 16%, China - 6%). In 2010 according to experts, the global market for high-tech products should have amounted to 3.5 trillion US dollars, of which 1.2 trillion US dollars should be accounted for by information, technology. [See [ 4.].

The volume of world trade in licenses for intellectual property is increasing annually by 12%, at a global industrial production growth rate of 2,5-3% per year.[See:[ 3.]. Therefore, the formation of an innovative economy should become a strategic direction for the development of the economy of Uzbekistan in practice. The creation of new knowledge and technologies and their use in the interests of socio-economic development of the state will determine the role and place of the population and ensuring national security. From the point of view of material factors, the main features of an innovative economy are:

- the availability of modern information technologies and computerized systems;
- the presence of developed infrastructure for the creation of national information resources;
- -accelerated automation and computerization of all spheres and industries of production and management;
- creation and implementation of innovation for various functional purposes.

A necessary condition for the functioning of the above factors is a flexible system of advanced training and retraining of qualified specialists. An important condition for the formation of subjects of modernization of society is a high quality education. The presence of an innovative system – a developed network of universities, laboratories, scientific centers is one of the prerequisites for modernizing society. Researchers have identified a connection

between the spread of education in different countries of the world and the beginning of economic growth and found that, as a rule, after the educational reform it took 25-30 years for the economy to begin to grow significantly in one country to another.

A.Maddison, the author of the research “Dynamic Forces in Capitalist Development: A Long-run Comparative View” found that the higher proportion of educated people in the country’s population, the higher the rate of economic growth. He also deduced the dependence, according to which an increase in education allocation by 1% leads to an increase in the country’s gross domestic product by 0.35% [see: [5.]. Another important aspect of education that contributes to the formation of an innovative culture and innovative development is that modernization of society, the economy of innovation should be based on a new educational paradigm: the ability to learn and relearn throughout life in order to flexibly respond to production needs and changes in the job market. This the most important condition for the formation of the main subject of society modernization in mass scale.

In this regard, it seems important to consider the main features inherent in the main subjects of innovation, which are the creators- innovators:

- 1) independence: when personal standards are more important than group standards, when there is a non-conformism of assessments and judgments;
- 2) open mind: a willingness to believe your own and others fantasies.
- 3) high tolerance to uncertain and insoluble situations and constructive activity in these situations;
- 4) developed aesthetic feeling, the desire for beauty as a completely unmotivated pleasure;
- 5) often in this series psychologists also mention confidence in their abilities and strength of character;
- 6) also mixed features of masculinity and femininity in behavior, which is noted not only by psychologists, but also by genetics.[2.191.]

It should also be noted, that, as a rule, each innovator has a peculiar style, a unique palette of knowledge and techniques, a unique creative intuition, a unique get of competencies and expert knowledge. Thus, an innovator is a creative person, with a creative energy of creation, aimed at positive and constructive transformations. A key figure in innovative activity is a creative intellectual, for whom the purely semantic component of his activity and the internal motivation are of the greatest importance.

A specialist working in a modernized society should be able to: a) see and pose a problem; b) propose solutions and choose the best in specific conditions; c) design the implementation of the





decision; d) be able to manage the process of changes, they are inevitable in principle.

In modern production, and organization, as a rule, teams and not single specialists work on the problem. Therefore, it seems important to note the principles of the innovation group. They are subject to special requirements due to the need for clear coordination of actions. Personnel management in innovation team significantly differ from traditional forms of management. In innovation group, the status of its members is determined not by seniority in the hierarchy, lack of education, the presence of degrees and titles, but by the value of the ideas put forward, the level of creative abilities and the ability to work in a team.

In the conditions of modernization of society, as already noted, information turns into knowledge, and knowledge into money, that is, knowledge becomes a source of value. Therefore, the modern economy as a whole and enterprises in particular, require that they be led by specialists who are able to identify and implement knowledge in new products and services, ahead of competitors.

In the conditions of Uzbekistan, the realization of the benefits of modernizing society is complicated by the lack of mutually beneficial partnerships between leaders of Government, enterprises with creative intellectual who, by creating innovative groups, could launch the mechanism of an innovative economy. Conservative forms of organization of production, outdated forms of management, the lack of quick and effective assistance from the authorities, often the lack of knowledge, competence of owners of private and leaders of the public sectors of the economy, as well as the continued monopolism, caused fear of innovation, calculated risk and ultimately, inefficiency and lack of competitiveness of enterprises. According to the opinion of Uzbek researcher "It is necessary to improve the existing and search for new methodological approaches to the organization of innovation activities at the enterprise, taking into account the state of the external and internal environment, the current position and the tasks of the strategic development of the economy in market conditions, to implement an innovation strategy at industrial enterprises".[6.5]

It must be borne in mind that in the conditions of Uzbekistan it will not be possible to immediately form all the elements of modernization of society on a massive scale, firstly, due to the fact that emergence of elements, to a large extent is interdependent with other elements. Secondly, it depends on borrowing foreign experience, that needs to be well mastered. Thirdly, requires a certain minimum in the real economy of the country in order for this mechanism to start working.

Various elements of the modernization of society will ripen unevenly (which, however, is happening). At present, the upper echelon of power is the most active, that is logically for the post-Soviet space, when initiatives come from above, due to paternalistic oriented consciousness of the population. When introducing innovations, we cannot calculate everything in advance. But this does not mean that we need to wait for call conditions to arise. We need to act all levels and learn along the way, adjusting our actions based on actual conditions.

One of the important areas is using various means and methods to prepare various parts of population of the society for the adoption of innovations. At the same time, the conservative part of society due to misunderstanding, unfamiliarity or the need to make additional efforts may not accept innovations and even hinder their spread. To a certain extent, this is natural, since in a historically short period of time there is a distorted perception of change, and come times the desire to suppress a new, alternative as unacceptable. A striking example from the history of science is the persecution of proponents of the development of genetics and cybernetics in the former Soviet Union in middle of the last century.

One of the options for further development, in our option, could be the following: government structures, regional authorities, international organizations, as a result of careful analysis, select production spheres, enterprises and, on the basis of competition, give them to innovation teams that determine forms of management, organizational structures and other components of the production process. As a result of this approaches, it would be possible to determine the models for the specific conditions of Uzbekistan. A prerequisite is observation, monitoring by representatives of science and international experts, the objectivity of competitions, the competence of experts, and absence of an ideological dictate.

For experienced innovation professionals working in transition economies, it is known that for some time you can go forward without any problems, then you have to step back, avoid obstacles, move along parallel routes, then combine paths and move forward again.

Uzbekistan certainly has great potential, since the country has managed to preserve its scientific potential: the level and volume of scientific research conducted by scientific organizations with the support of the state is quite high, which is one of our most valuable goals. However, it should be noted that in the scientific, and especially in the scientific and technical sphere, the market approach implies such an organization of the process in which scientific results are transformed into high-tech competitive products or technology.[6] That's why, we believe that with a high degree of probability,





such a model will work in the process of reforming the economy of Uzbekistan.

## REFERENCES

1. *Экономическое обозрение, 2005, № 5, с.5. (Economic review 2005, № 5, с.5)*
2. *Богоявленская Д.Б. Исследование проблем психологии творчества. М. 1983, с.191.*
3. *См. Фомичев Ф. Интеллектуальная собственность: правовая защита, управление, коммерциализация. // Человек и труд № 3 2004.*
4. *См. Лукьянов Ф. Путин-2: Невропейская Россия // Россия в глобальной политике. 2004.*
5. *Maddison A. Dynamic Forces in Capitalist Development : a Long-Run Comparative View. – amazon.com*
6. *Bekmuhamedova B.U., Implementation of innovation strategy at Uzbekistan industrial enterprises // Вопросы экономики и управления Международный научный журнал № 3 (19) / 2019*
7. *Decree of W.AND. O. Of the President of the Republic of Uzbekistan Shavkat Mirziyoyev «On additional measures to ensure accelerated development of entrepreneurial activity, the full protection of private property and the qualitative improvement of the business climate» of October 5, 2016*



## **POLITICAL ACTIVITY OF USMON HOJA POLATHOJAEV IN THE YEARS OF BPSR (1920-1924)**

**Akmal Mahmudov Mannonjonovich**

*Basic Doctoral Student of Ferghana State university, department of History.  
Ferghana, Uzbekistan*

### **ANNOTATION**

*In this article some opinions (ideas), gained through the empirical historical sources, on the social-political activity of a progressive fighter for independence from Bukhara Usmon Hoja Polathojaev in the years of BPSR are expressed.*

**KEY WORDS:** *progressive, government, minister, financial minister, nationalist(ic), chairman of the republic (jumhurrais), treasure of the emirate, emigrant, Western Bukhara*

### **DISCUSSION**

Due to the Independence gained in Uzbekistan the historical truth about hundreds of our countrymen who came of our nation and were unjustly insulted and humiliated during the years of the Soviet power has been restored. And such good tendencies in this direction are still going on. One of such historical people is Usmon Hoja Polathojaev (1878-1968) and his life embraces the events full of complicated and contradictory things.

Usmon Hoja Polathojaev was the frontman of the Jadid movement. After the Bukhara emirate order had been abolished (overturned), he worked (1920-1922) at the responsible posts in the government of the Bukhara People's Republic formed under the leadership of Fayzulla Hojaev (1896-1938).

This article throws light on the activity of Usmon Hoja Polathojaev in Bukhara during the mentioned years.

Usmon Hoja Polathojaev's social-political activity may be divided into two periods and several phases. In the first period Usmon Hoja Polathojaev lived and worked in Bukhara – his ancestors' country. He took part in the first Movement for progress. In the second period he became one of the activists of the movement "the Bukhara Youth". In the years of BPSR government (1920-1924) till he emigrated he had occupied the high responsible posts. He had to live (1918-1920) in Tashkent and Samarkand of Turkestan because of the abrupt political situation in the Emirate. It is known that on October 6-8 in Mohi-Hossa (the summer headquarters of the Bukhara emirs – A.M.) there was held the first Qurultoy of the Bukhara toilers and the

Bukhara People's Republic, the new government and the shuro (cabinet) of the People's Ministers were formed. Usmon Hoja Polathojaev who had a political authoritativeness in the government of F. Hojaev held the post of the minister of finance.

In 1920-1921 he launched a number of decrees (orders) to put the financial problems in order, to withdraw the money without the seal and the faked money in cash from circulation. On October 19 of 1920 as to order №3 of the financial minister of the Bukhara government it was obligatory that the money in cash without the seal should be categorically withdrawn from the circulation [1].

In those years the BPSR government had already faced many financial problems, and in the emirate period during which the agriculture and the industry had been derailed and the inflation had reached its peak because of the military clashes within the Republican territory, the circulation of the new government currency was introduced and the Turkestan ASSR bank was founded [2].

In order to create the treasury of the BPSR government he worked actively in the commission organized to dig out the former Emir's gold and the silver buried into the earth in the huts as to various reasons during the occupation by the Red Army. He was for the treasure to be spent on the prosperity of the Bukhara people. As to the reminiscences of Fayzulla Hoja Muhammadiev who was the treasure man of the period under the reign of Emir Abdulahat, Usmon Hoja as the minister of finance invited him to his office 2-3 times and gave him the following opinion: "If there are the gold remains still left, it is not useful for us to show the Russians



those places, you have to mislead them. We need the Bukhara gold ourselves[3]”.

As to the information of the scholar-historian Sotimjon Holboev from the two treasuries hidden from the Red Army invaders the 200 food of gold(3 tons and 200 kg), the 9600 food of silver(153 tons and 600 kg) treasure was dug out. During 15 days these treasures had been counted up by the commission including 5-6 members of the government(Muhiddin Mansurov,Abduqodir Muhiddinov, Usmon Hoja, Nosir Hakimov, etc. – A.M). In reserving this treasure the main role was played by the following instruction of Usmon Hoja to the treasure man Fayzullohoja: “You should not show them( the Red Army members- A.M.) those places( of treasure), you should mislead them, you must show them the old places from where the treasure had been confiscated and tell them that the gold used to be kept only in one place[4]”.

Due to the initiative of Usmon Hoja Polathojaev and Fayzulla Hojaev owing to the treasure preserved in Bukhara the people of the Bukhara People’s Soviet Republic were remitted of their tax and the Bukhara pupils and students were sent to Germany, Turkey and other Eastern countries to get educated there, and the basis for their provisions were created.

Usmon Hoja Polathojaev was well aware of the world financial changes because besides his mother tongue he knew the Persian and Turkish languages and he was constantly reading the newspapers and magazines[5].

Usmon Hoja Polathojaev worked at the Fayzulla Hojaev’s government as the minister of state inspection(1921), as the chairman of the Central executive committee of the BPSR (1921, August , the beginning of 1922)[6]. In the periodicals of that time it became known that at the same time Usmon Hoja was working as the 1-st vice minister of the military affairs. The message given in the “ Bukhara ahbor”, issued on November 14, “ After many discussions by unanimous decision Yusuf Ibrohimov’s candidacy was nominated for the post of the minister of the military affairs and the candidacy of Usmon Hoja Polathojaev was recommended for the post of the vice minister of the military affairs. These candidacies had been approved at the revcom”[7] confirms our opinion.

The BPSR government established the diplomatic relations with such Eastern countries as Turkey, Iran and Afghanistan. As early as January of 1920 the Turkish Parliament(National Meeting) had adopted the declaration “ National consensus”. In 1920, on April 23 the chairman of the Turkish Great National Meeting(TGNM) M.Kamol Otaturk asked for material assistance from Russia. Later on in 1920 the Bukhara representatives were sent to the

“Provisional Ankara Government” and M. Kamol was presented with a gold handled saber by them.

By that time in 1921 on March 16, Turkey had signed the diplomatic treaties with the RSFSR, in 1921, on October 13, with the Transcaucasian Republics, and in 1922, on January 2 , with the Ukrainian SSR. In the literature of the Soviet period it is said that “ the Soviet Government assisted Turkey with 10 million sums’ worth of weapons and ammunition in gold”[8]. In reality at that time in 1920-1921 the Soviet government ringed in the fronts was not able to render Turkey a material and military assistance. V.I. Lenin and M.I.Kalinin had already given a negative answer to the request of the Turkish representative in Moscow Bekir Samibey on the very issue. And Usmon Hoja Polathojaev transferred to the Moscow bank 100 mln sums in gold to send it to Turkey. And this fact was evidenced by the Turkish historian Mehmet Saray based on the historical facts[9]. Mehmet Saray stressed that the question of the military assistance had been discussed at the meeting of the Presidium of the revolutionary committee of the BPSR, that the BCP leader Najib Husainov was against the assistance to Turkey by the Bukhara Republic.

The Soviet government was an intermediary between the two countries and it strengthened its military position by 10/9 of the means and succeeded in transferring Usmon Hoja and the BPSR’s material assistance to Turkey into its own account. In Turkish people’s gaining of independence and in its victory over the strong enemy in the fierce fights it is important that Usmon Hoja Polathojaev made his worthy contribution.

While working in the structure of the BPSR government Usmon Hoja Polathojaev fought for solving such problems as taking the arable lands into strict account and their being orderly used, restoring the ruined Bukhara, opening the cultural and spiritual institutions, reconstructing the architectural monuments, driving the 30 thousand Red army soldiers out of Bukhara, founding the national army, gaining independence in the international affairs without any orders from the “Centre”, strengthening the borders of the country, giving Uzbek the status of an official state language and implementing it into life, etc[10]. 1921-1922 Moscow’s interference in the internal affairs of the Bukhara Republic was intensified. The Bukhara National army was subordinated to the RSFSR revolutionary military council headquarters. It’s known that in 1921-1922 there was strengthened the basmachi( independence )movement in Eastern Bukhara. Though for a while the Soviet leaders used such well-known members of the Bukhara government as Usmon Hoja Polathojaev in the appeasement of the freedom fighters. In 1921, on March 10, there was formed the all Bukhara CEC’s extraordinary affairs mission in Eastern



Bukhara and its chairman was Usmon Hoja Polathojaev and Mirzoanvar Azimov and Abdulhakim Qulmuhammedov were its members. In 1921, on August 12 Usmon Hoja Polathojaev met with Davlatmandbiy in Boljuvon and through the negotiations succeeded in signing a treaty. The two sides were seeking their own benefit from the authoritative position of Usmon Hoja Polathojaev.” Anvar Poshsho sent an ultimatum letter to the RSFSR consul Nagorniy demanding that the Russian troops should be withdrawn from Turkestan and Bukhara”[11]. And the Red entrusted the chairman of the republic with a responsible task of gathering food from the people, providing the army with it and of appeasing the people.

Sayyid Mansur Olimiy wrote that “in by 1922 the party of the “Bukara Youth” also had become weak. Having known their such intentions some of the “Bukhara Youth” left the party and joined Anvar poshsho and Ibrohimbek. Usmon Hoja was one of them”[12]. In 1922, on January 22, in Bukhara after the formation of the “Extraordinary dictatorship commission” and the declaration of martial law (military situation) on February 1, the situation got aggravated and it was authorized that in Bukhara without any obstacles any suspected person should be arrested or driven out of the country. It is necessary to stress that one of those persons who realized the urgent need for an ally between the government and the members of the “Independence movement” was Usmon Hoja Polathojaev.

”When the muslim warriors under the leadership of Abdukahhor came to the Mehtar Kosim bridge and circled Bukhara from all sides, the Bukhara military minister Abdulhamid afandi, with the 20 Bukhara and the turkish people accompanied by Usmon Hoja came out to welcome general Abdukahhor. They gave the muhojids 6 thousand pounds of sterling and military weapons, and expressed their desire to go to Anvar poshsho who had been fighting in Eastern Bukhara and join the the detachment of the mujojids”[13].

In the historical literature it is stated that “Usmon Hoja Polathojaev had left the Bukhara Republic and joined Anvar poshsho. But one of his future intentions was to cross the border of Afganistan and to form a national army and restore the independence at the expence of the military assistance from the English. In 1922 after F.Hojaev’s such an instruction as: ” The situation is bad, don’t return!” Usmon Hoja had to remain abroad for good”[14].

About Usmon Hoja’s deserting to the side of those who had been leading an armed struggle against the soviet regime and after that his emigration abroad professor H.Sh. Inoyatov wrote: “ In October of 1921 Anvar poshsho - Turkey’s former military minister, who had links with the English

intelligence service came to the Old Bukhara, in order to hold negotiations with such traitors as Usmon Hoja and Ali Rizo.... Usmon Hoja, Doniyor afandi and Ali Rizo came to Dushanbe with a detachment consisting of 800 members(out of that 600 members were the militia) in order to put an end to the basmachi movement. He passed on to the side of Anvar poshsho”[15]. From this information written in the pattern of the soviet ideology it might be assumed that Usmon Hoja had been a traitor and under Anvar poshsho’s propaganda and influence he had deserted to the side of the basmachi(independence) movement.

Historician scholar Q. Rajabov wrote that ”when Usmon Hoja was on his service trip in Eastern Bukhara as an extraordinary representative of the BPSR, on December 9, 1921, by the help of his assistants – the vice Ministry of the Military affairs Ali Rizobek, commander of Termez Harrison Hasanbek and Doniyorbek, he unarmed the Red army soldiers in Dushanbe. At that time the Turkish military commander Anvar poshsho, who was staying at the headquarters of Ibrohimbek basmachi, sent his assistants Hoji Somiy and Usmon afandi together with a group of soldiers in order to help him( Usmon Hoja). But having found no common language with Ibrohimbek, Usmon Hoja retreated to the Bobotog side, and at the beginning of January of 1922, came to Behbudiy(the now Karshi) together with the military unit under him. When he was staying there he made up his firm decision to sever relations with the Soviets and pass on to the side of the independence movement”[16].

Professor Q.Rajabov confirmed that Usmon Hoja had had a negotiation on the formation and armament of the national army, but all his attempts had been in vain, and Fayzulla Hodjaev’s warning letter made him remain abroad. The very opinion was moved by the historian scholar Sh.A.Hayitov.

## CONCLUSION

In 1922-1924 when serving in the structure of the BPSR Usmon Hoja Polathojaev was a true fighter for independence in the deepest sense of the word. Because of the policy of the force and superpower pursued by the Centre our countryman Usmon Hoja had to emigrate abroad from our country.

**REFERENCES**

1. *Order of the Minister of Finance // Bukhara News, No. 8, November 21, 1920*
2. *Xayitov Sh.X. Bakhriddinov S., Rakhmonov K. Bukhara People's Soviet Republic: economy, social policy, cultural life. Bukhara "Bukhara" publishing house. 2005-B. 22-25*
3. *See Xolboev S. Golden treasure of Bukhara emirate (history, destiny, analysis) - T., Science, 2008.-B 73-77, 80-91*
4. *The same book, pp.74-76*
5. *Boltaboev H. Abdurauf Fitrat // Communication; 1996, №4- B.51*
6. *Muhammad Ali Baljuvani. History nofeyi. T: 2001; B.18. Rajabob Q. independence fighter // 2006*
1. *4 16-28 / II*
7. *Commands and decisions // Bukhara news. No. 14 November 14, 1920*
8. *Uzbek Soviet Encyclopedia, 1978, Volume II, P.387*
9. *Mehmet Saray. Mulli Mucadele Willarinda Bukhara Cumhuriyetinin Turkiye Vardimi. Venetian Actions and Uprisings in Turkestan. 1900-1924. Haarlem. 2001: S.339-346.*
10. *Hayitov Sh., Sobirov N., Legay A., Uzbeks Abroad.-T.: Science. 1992.-P.18., Hayitov Sh., History of Uzbek emigration (1917-1991) –T. PRESS CONSULTATION, 2008.-P.45-46.*
11. *Rashidov U.J. The first stage of the resistance movement in the Republic of Bukhara (1920-1922) "Issues of the history of Bukhara" (collection of articles). Buxoro-1996.B.117*
12. *Sayyid Mansur Olim. "Bukhara-Turkestan cradle". Buxoro 2004 y.B.98*
13. *Sayyid Mansur Olim. "Bukhara-Turkestan cradle". Buxoro 2004 y.B.102.*
14. *Temur Khoja. "I am not in the homeland, the homeland is in me" // Relationship. November 30, 1990. Usmanov I. Zuhim will stay in Uzbekistan // Muloqot, 1991.№2.B.47-51.*
15. *Inoyatov H.Sh. Narody Sredney Aziiv borbe against interventions and internal counterrevolyutsii. Moscow. Mysl; 1984; S.370; 371.*
16. *Rajabov K. Istiqlol kurashchisi // Vaziyat; 2006,16-28 / II, Hayitov Sh. Usmon Khoja Pulatkhodjaev - national independence fighter. Bukhara; 2007.-P.28.*





# PRACTICES OF INDUSTRIAL RELATIONS IN AN INDIAN SUGAR INDUSTRY: AN EMPIRICAL STUDY

**Ms. N.Anupama<sup>1</sup>**

*<sup>1</sup> Research Scholar, Dept. of Management, Dravidian University, Kuppam, Chittoor, Andhra Pradesh.*

**Prof.G.L.Narayanappa<sup>2</sup>**

*<sup>2</sup>Dean, School of Commerce and Management, Dravidian University, Kuppam, Chittoor, Andhra Pradesh.*

Article DOI: <https://doi.org/10.36713/epra4751>

## INTRODUCTION

'JUPITER' sugars India LTD was founded in the year 1941 in southern India as a private sugar factory. Later it has enhanced its production from 1000 TCD to 8500 TCD in the year 1962. It was amalgamating of many sub units and multi locational products into its main unit. The company has focussed its attention on various projects and substantial resources. Subsequently, they have decided to organise the company into two units one in southern India and one in northern India.

The sugar industry workers today are progressively taught and they know about their duties and rights. The executives need to manage them not merely as factors of production; however as people having human pride and dignity. The goal of sugar industry is to change the traditional perspectives of management and labour towards one another and create mutual understanding and co-operation and work towards accomplishment of common goal. Good industrial relations lead to industrial harmony and increase in production sugar industry. Joint consultation among workers and the board paves the way for industrial democracy and they contribute to the growth of the organisation.

## IMPORTANCE OF INDUSTRIAL RELATIONS IN INDIAN SUGAR INDUSTRY

Favourable industrial relations spur the labourers to give amplified output of the sugar industry. Issues are comprehended through shared conversations, workers' participation, suggestion schemes, joint meeting, etc. Righteous industrial relations enhance work proficiency and efficiency of sugar industry. The Profitable industrial relations are consistently the key for the advancement and achievement of any organization as well as for its employees (Schuler, 1989)<sup>1</sup>. The need and significance of IR has been discussed with specific points as below:

Superior industrial relations impact employees' commitment emphatically. Accordingly, the industrial harmony lies eventually in a changed point of view toward the part of employers and employees. Therefore it is basic with respect to company leadership, representatives and Government to work out another relationship in consonance with a feeling of accurate democracy. They should figure themselves as associates of the business and the role of workers in such an organization ought to be perceived. This above firm and relationship gets shared remunerating for every one of them and further contributes to good industrial relations.



## SELECT REVIEW OF LITERATURE

Sen Gupta and Anil K Sett (2000)<sup>2</sup> have examined the debate on reforms in industrial relations law in India, which are needed to support its economic liberalization programme. Analyzing a distinctive Indian experience of state intervention in industrial relations, it is opined that the thrust of the reform should be towards highlighting the union recognition and promotion of industrial harmony.

RatanSen (2003)<sup>3</sup> in his compendium he stated that the study of industrial relations in India, covered several new topics like organizational communication, knowledge workers and their management, voluntary retirement schemes, quality circles and analysis of collective agreements.

Mathur.A.S. (2006)<sup>4</sup> has opined that the problems of human relationship arising from the sale of services for a wage and working on the premises of employers under their control form the subject matter of industrial relations.

Ram Reddy (2006)<sup>5</sup> through his study identified the factors which were responsible for the adverse labour management relations in Singareni Collieries and to suggest suitable remedies. The study also aims to evaluate the industrial relations policy of the Government and the processes evolved by it. The researcher ascertains the effectiveness of the various preventive processes adopted in Singareni Collieries for establishing of harmonious labour management relations and the causes for their failure. The study identified the root causes of strikes in Singareni Collieries and suggests measures for minimizing the industrial unrest.

Rezual Hua (2006)<sup>6</sup> has analysed the present scenario of Indian Industrial Relations equitable. The industrial relations should be considered as an essential part of management systems and techniques and not as a discipline or activity apart from management. This report scrutinizes the three main approach, economic rationalism, civil libertarianism and equal employment opportunity and social justice too. Further, the study identified that there is an inequality of Industrial relation such as child labour, cross culture management, trade union wage discrimination and individualism.

## OBJECTIVES

The specific objectives of this paper are ;

- I. to assess the contemporary patterns industrial relations such as (i) collective bargaining; and (ii) grievance handling mechanism in 'JUPITER' Sugars India Limited;
- II. to measure the level of satisfaction/dissatisfaction of employees/workers towards the

contemporary patterns of collective bargaining and grievance handling mechanism in 'JUPITER' Sugars India Limited;

- III. to identify the reasons for the dissatisfaction of employees/workers towards the contemporary patterns of collective bargaining and grievance handling mechanism in 'JUPITER' Sugars India Limited; and  
to offer the feasible ways and means to streamline and contemporary patterns of collective bargaining and grievance handling mechanism in 'JUPITER' Sugars India Limited.

## RESEARCH METHODOLOGY

The methodology consists of data collection from primary as well as secondary source. Through the survey method, the firsthand information was collected from 60 sample respondents from the study unit.

### Sample design and size

A purposive-cum-convenient sampling technique was followed and 60 respondents were chosen as sample respondents from the study unit.

### Analysis of the data

The information collected from the sample respondents was processed and tabulated scientifically and several statistical tools like (i) independent sample t-test; (ii) weighted mean scores; and (iii) ANOVA are calculated at appropriate levels.

### The Limitations

1. The study is confined to only one sugar unit;
2. The size of the sample is 60 only where the number is very meagre.

## RESEARCH FINDINGS

1. The present collective bargaining procedure is making enormous delay for discussion and for finding out the solutions for the problems, since the management or the management representatives have to discharge multiple responsibilities in the organisation and the time sparing for attending this procedure is also minute(53.33%).
2. The management is not at all sticking on to the collective agreements which are compiling in collective bargaining procedure and utterly deviating the collective agreements. As a result, the employees/ workers are forced to be resorted for strike (48.33%).
3. Total charter of demands put forth by the workers is not addressed in the collective bargaining process. Only part of them are



addressed by the management. Hence, for the next schedule of collective bargaining process, the items to be discussed in the process are becoming huge (43.33%).

- Both the management and the management representatives are not able to properly understand the grievances of employees/workers and hence there is big gap in the understanding level of the grievances of workers (38.33%).
- The designated officials for whom the management appointed for handling grievances are not positively appraising the employees grievances to the management not and hence the grievance are not able to be redressed positively on time (36.66%).

### SUGGESTIONS

- The process of collective bargaining must expedited on war footing basis. Time schedules are to fixed for discussion and negotiation of each item on scientific basis. For ex: 7 days of time should be fixed for addressing a minor issue in the process of collective bargaining. Similarly 15 days should be fixed for addressing a major problem or any other problem in the process. The solutions identified in the collective bargaining process should be intimated to the concerned employee within 24 hours of the completion of collective bargaining process. Further, the multiple responsibilities lies on the shoulders of management and management representatives should be decentralized and the same may be entrusted to designated officers. So that the multiple responsibilities lies on the heads of the management and management representatives would be reduced and they can freely concentrate on the various issues to be discussed in collective bargaining.
- The collective agreements which are compiled with the mutual concern of employees and the management should be uploaded in the company's website for want of transparency. So that the unnecessary mis-understandings and deviations between employees and the management can be wiped out.
- Before entering into the collective bargaining process the total charter of demands demanded by the employees/workers should be transparently incorporated into the agenda of the collective bargaining process and the same may be uploaded into the company's

website also. Further, almost all the demands demanded by the employees should be solved without single exception. So that the leftover demands cannot be accumulated to the forth coming process of collective bargaining.

- The management or the representatives of management should properly understand the grievances of the employees sympathetically. Further, they should have positive attitude towards the redressal of the employee's grievances. So that the functional distance between the employees and the management can be wiped out.
- While undertaking the process of grievance handling mechanism, the concerned officials or the representatives of the management should positively appraise the work performance, caliber and characteristics of the concerned employees whose matters are discussing in the collective bargaining process. So that the concerned officials will have positive attitude on the grievances of the employees and they can sympathetically consider their grievances and find out reasonable solutions for the same.

### REFERENCES

- Randall S. Schuler (1989), "Determinants of Human Resource Management Priorities and Implication for Industrial Relations", *Journal of Management*, Vol.15, No.1, Pg. No. 89-99.
- Sen Gupta and Anil K Sett: "Industrial Relations Law, Employment Security and Collective Bargaining in India: Myths, Realities and Hopes", *Industrial Relations Journal*, Vol.31, Issue.2, 2000, pp.144-153.
- RatanSen: "Industrial Relations in India-Shifting Paradigms", *Indian Journal of Industrial Relations*, Vol.39, No.2, October 2003, pp.265-267.
- Mathur.A.S.: "Management and Labour Studies", Vol.24, No.4, February 2006, pp.34-45.
- Ram Reddy: "Industrial Relations in India: A study of the Singareni Collieries" A Ph.D Thesis submitted to the Osmania University, 2006.
- RezaulHua: "Industrial Relations in India", *Journal of European Industrial Training*, Vol.22, No.2-4, April 2006, pp. 125-136.



## OPPORTUNITIES AND CHALLENGES ON CONSERVATION OF AMBATARA PROTECTED AREA, SEDE MUJA DISTRICT, ETHIOPIA

**Haile Zerfu Munaw**

*Ethiopian Environment and Forest Research Institute, P.O.BOX 2322 Addis Ababa, Ethiopia*

Article DOI: <https://doi.org/10.36713/epra4822>

### ABSTRACT

*Protected areas (PAs) are designated areas that are protected because of their environmental, cultural, or other worth. It plays a vital role in biodiversity conservation. Ethiopia has more many PAs, which cover 17.1% of the nation, protected to gain benefits for livelihoods at the local, regional and country level but the value obtained from the protected areas is very low.*

*An effective conservation of management practice for protected areas is one of the selected approach to make the harmony relationship between PAs and the local community in a given ecosystem. However, its practical implementation in protected areas through community method is the major challenge in Ethiopia. This study described the main opportunities and challenges of Ambatara protected Area (APA), Sede Muja District, Ethiopia.*

*Data were collected and organized by the household survey, key informant interview, field observation and focused group discussion (FGD) methods using both primary and secondary data sources in the form of qualitative, quantitative, or both from July 2019 to September 2019.*

*The results were explained the socioeconomic, opportunities and challenges. The establishment of community-based PA management in Ethiopia, proclamation and regulations of wildlife managements of Ethiopia, and natural recovery ability of the area were its potential opportunities whereas, local community - wildlife conflict, conflicting between the APA management & local community, inadequate coordination among stakeholders, and challenges & threats of APA were the main challenges of APA conservation.*

**KEYWORDS:** *APA, opportunities and challenges, local community, PA*

### INTRODUCTION

Protected areas are policy tools for conservation and sustainable use of natural resources, an essential tool to achieve conservation and sustainable development. It maintains biological and cultural diversity, helps to improve the livelihoods of the local community, provide the homelands for many indigenous peoples and bring countless benefits to society in general (Dudley, 2008).

The instituting and administration of PAs and the use of resources in and around them must be socially responsive and just. In addition, the growth of human activities in PAs, which are compatible

with conservation objectives, should be accepted (IUCN, 1993) cited in (Trakolis, 2001). Nowadays, there are over 147,000 PAs in the world, covering the total area of 19.3 million km<sup>2</sup>, which is 13 % of the Earth's total land area, or nearly the size of the entire African continent. On the other hand, only 0.8 % of the global ocean area constitutes protected marine areas (Danijela, 2016).

In general, the distribution of natural resources and biodiversity does not respect international boundaries (Reader, 1999). Ever since individuals began to create settlements, they made boundaries to protect their territory and property.



Animals, rivers, or mountain ranges do not recognize man made borders; they follow nature's design (Federation, 2010).

In particular, human activities remain to affect the capacity of Global systems to sustain life to the extent it is becoming the defining challenge for the 21st Century, and core to the Anthropocene concept (Steffen et al., 2011). On the other hand, the gazettement and management of protected areas will bring hardships to poor rural communities living in and around them (Infield & Namara, 2001) due to loss of economic opportunities and exclusion from protected area resources (Infield & Namara, 2001) and crop destruction & livestock depredation by wild animals (Infield & Namara, 2001).

Nowadays, in Ethiopia, efforts have been made for the establishment of the national park, wildlife sanctuaries and reserves gain benefits for livelihoods at local, regional and country level, but the value got from the PAs is very low when it is compared to other African countries. The majority of the PAs of the country face a severe threat from illegal poaching, deforestation, farming, and conflicts on rival park resources (Chanie and Tesfaye, 2015).

However, these PAs are degrading and facing, threats because of enlargement of population and settlement, illegal agricultural expansion, habitat loss and destruction, grazing, deforestation, soil degradation and misuse of natural resource in the country (Muluaem and Tesfahunegny, 2016). On the other hand, according to Ababa et al. (2012) cited by Getahun (2017) lack of comprehensive national and international policies, less commitment from government organs, shortage of finances, and

requirements of education to raise awareness are the other challenges of PAs in the country.

The local community expands, settlement, deforestation, illegal resource extraction, farmland expansion, and grazing land, etc., are critically challenged APA, on the other hand, crop destruction and livestock predation have become the major wildlife conflicts. Moreover, the absence of or inefficient implementation policy, which fails to maintain the economic compensation with fair market value is an additional challenge in conservation. This study, carried out to identify the conservation challenges and opportunities on APA. Furthermore, no scientific studies have yet been conducted in the area to assess the opportunities and challenges with conservations of APA. Hence, this study is very critical to fill this gap.

Therefore, the objective of the study was to understand and investigate the conservation Opportunities and Challenges of Ambatara protected Area, Sede Muja District, Ethiopia.

## METHODOLOGY

### 1.1 Description of the study area

The study was conducted on Ambatara Protected Area (APA), Sede Muja district, South Gondar zone, northwest Ethiopia, which is located approximately 740 km from Addis Ababa. Sede Muja district administered under South Gondar Administrative Zone, which lies within 11°08'57"–11°40'27"N latitude and 38°12'44"–38°38'40"E longitude. APA is unique because of its biodiversity and woodland ecosystem. The APA has been selected to assess and investigate its interactions with the community.

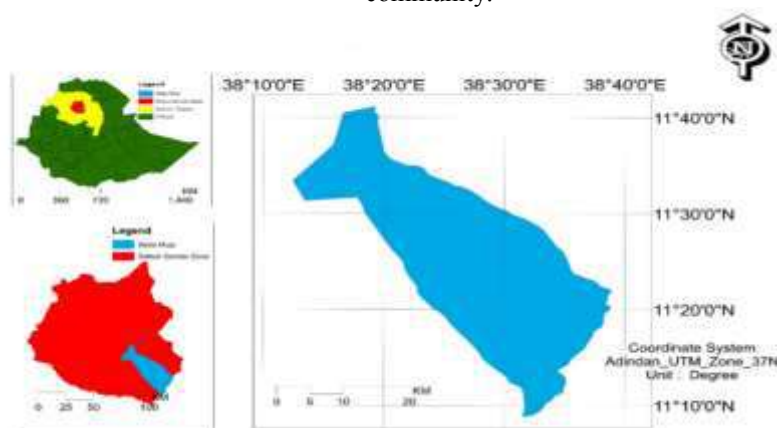


Figure 0-1 Map Sede Muja district study area.





## 1.2 Sampling design and method

### 1.2.1 Sampling design and size

A randomly sampling (De Vos, 2011), 305 participants out of 1286 total residents aged 18 years or older (Snyman, 2013, 2014) living within 10 km and interacting with APA (Oldekop et al., 2016) at 95% using a sample size (Israel, 2012) were interviewed.

#### Sample size

$$\text{formula } n = \frac{N}{(1+N(e)^2)} \quad (0-1)$$

Where 'n' is the number of selected sample size head households or respondents, 'N' is the total household targeted population size and 'e' is the level of precision.

### 1.2.2 Data collection

Data collection was conducted from July 2019 to September 2019 and included a household survey, key informant interview, field observation, and focused group discussion (FGD).

**Household survey:** Household heads were selected randomly to give an equal chance for all targeted residents. However, because of the rain and ploughing time, the majority of respondents were responded on the weekend. Information on age, education, distance from the park, economic activities, purpose of PA natural resources, view of compensation, attitudes towards the establishments of APA and others were collected. Before performing the interview, questionnaires were translated to Amharic language, and a half-day training was given for data collectors on how they can gather valuable data for the study. A clear explanation of the aim of the study was given to the interviewee to reduce the underestimation or overestimations of the study further on developing trust within the respondents. Preceding the start of the interview, the purpose of the study carefully explained to the respondent and their agreement to participate required (Kothari, 2004).

**Key informant interview:** Discussed with the district officials, APA, and stakeholders, and it was less strict formulated questionnaires that can offer the participants with a more relaxed to express their thoughts.

**Focus Group Discussion (FGD):** It was employed to collect qualitative information, and the group members in each FGD were consisted of 6-9, following (Mitchell and Branigan, 2000). FGD participants were selected based on their age, knowledge, and experiences within and around APA. Two FGDs were conducted; and each group consisted of two community leaders, two elders, two religious leaders, one expert from the APA, and one from the Sede Muja district. FGD was discussed on

changes, problems, historical perspective and the importance of the APA establishment.

**Field Observation:** For achieving adequate and relevant information concerning local communities and establishments of APA, observation on what respondents were on their daily activities for their livelihoods, an outline of their living environment, and interaction information was assessed.

### 1.2.3 Data analysis

The data analysis was conducted by using Statistical Package for Social Sciences (SPSS) version 20. Descriptive statistics such as frequencies, percentages, sum and mean were utilized summarize respondents' demographic and socioeconomic profiles. Inferential statistics, particularly chi-square tests, were utilized in outlining relationships between variables, explaining relevant conclusions; and establishing the factors that influencing the local community's attitudes toward the establishment of APA.

## RESULT AND DISCUSSIONS

### 1.3 Socioeconomic characteristic

After the replacement of the Emperor Ruling system in 1975, youth in rural areas of Ethiopia has been gaining farming land from local officials or their parents. Currently, however, because of limited farmland in the rural areas of Ethiopia have been become impossible to distribute for the young generation. Thus, elders have a better farmland size than compared to youth, except who retired and transferred their ownership of farmland to successors. Based on FDRE, 2005, Rural Land Administration and Use Proclamation (proc. 456/2005), farmers may have the right to get rural land (Art. 5.1). In addition, an individual above 18 years may get rural land; similarly, women have the claim to get Art. (5.2) (FDRE, 2005). The respondents lived in scattered settlement spread over around the Amabatara Protected Area (APA). The majority of the respondents were from the age group between 18-38 years (42.6%); followed by 39-59 years (37.7%). These two groups covered 80.3 % of the sample among the selected respondents (Table 3-1).

The percentage of male respondents were 93.44%, and the rest 6.57% was females. The total average family size was 4, with a range of from 2-9. Similarly, within age groups of 18-38, 39-59 and  $\geq 60$ , their average family size were 5.14, 5 and 3.05 respectively. Nearly one-third of respondents were uneducated farmers while the rest of them could read and write Amharic, the national language of Ethiopia. Respondents were had 2.34, 2.22 and 1.38



hectares of average farmland size, and also, 14.3, 12.86 and 7.88 average livestock sizes for age groups of 18-38, 39-59 and  $\geq 60$ , respectively. The national land use survey shows that the average

household farm size in Ethiopia is 1.22 hectares, but 57% of the households have farm sizes less than one hectare (CSA, 2012a).

**Table 0-1 Socioeconomic characteristics of the respondents**

Age Class	Sex		Sex		Average Family size	Average farmland (ha)	Average Livestock Size
	Female	Male	N	Total (%)			
18-38	8	122	130	42.6%	5.14	2.34	14.3
39-59	8	107	115	37.7%	5	2.22	12.86
$\geq 60$	4	56	60	19.7%	3.05	1.38	7.88
Total	20	285	305	100%	-	-	-

#### 1.4 Opportunities in APA conservation

##### 1.4.1 Establishment of community-based PA management in Ethiopia

Ethiopia owns considerable biodiversity and natural resources, as well as many endemic species. However, its wildlife conservation policy has been changing with the continuous changing regimes. It has had limited success in protecting some of these natural assets since establishing conservation and PA program in 1965, because of the nation's lengthy engagement in numerous armed conflicts. Moreover, given the potential of the park and biodiversity, the extent of protected areas and biodiversity conservation of the country is negligible missing protected area networks and management plans (Biodiversity Indicators Development National TaskForce, 2010).

The new management approach gives the considerations of local community rights and benefits. In addition, it ensures the sustainable conservations of protected areas, which are acceptable by the APA management and local community. To ensure the success of conservation, supporting the relationship between the community and protected area is crucial. However, failure to ensure participation residents, the absence of alternative livelihood, and widespread poverty, human settlement, grazing, absence of legally recognized boundaries of protected areas were persistent in the Ethiopian protected area (Eshetu, 2014) where local community used to utilize the land until they were declared protected areas.

##### 1.4.2 Proclamation and Regulations of Wildlife Managements of Ethiopia

Proclamation Number 541/2007 development, conservation and utilization of wildlife and regulation No 163/2008 wildlife development, conservation and utilization is other opportunities for management of protected areas. To attain, the objective of the conservation and management of PA, the declaration of the proclamation and regulation of

wildlife development and utilization has paramount importance. It gives outstanding highlighting to the triple role of the government, the community and investors and developmental NGOs (Federal Democratic Republic of Ethiopia( FDRE), 2008). The proclamation and regulation of wildlife conservations have a positive contribution to the establishment and conservations of APA.

##### 1.4.3 Natural recovery ability of the area

According to the field observations and the district evidences, the Ambatara Protected Area (APA) has many different natural resources. Its climatic condition is very suitable for the degraded most part to be recovered or regenerated within a short period. The long season of the weather condition is a dry season from October to May whereas from June up to September its rainy season. The local growing tree species are adapted to the local adapted the weather condition. The local optimum climatic conditions might be made helpful to increase their growth and just protecting the local area from human or other contacts will be helped in rehabilitating within a short period.

In general, the APA management should be initiating and implementing suitable conservation strategies considering the opportunities to make the sustainable conservations of the APA with satisfying the aspirations of the local community to make the coexistence of the APA and the local community.

##### 1.5 Challenges of APA conservation

Ethiopia is rich with biodiversity in nature, but little in capacity for biodiversity conservation or protected area management. Critically, it is expected that over 110 million people in Ethiopia, 85% in rural areas, and 80% in the highlands. The massive are almost entirely dependent on natural resources for livings. As a result, 97% of the original highland vegetation has already been lost in current decades because of encroaching agriculture, grazing and settlement by agro-pastoral communities. Poor



resource-dependent local community is still raising in Ethiopia, both within and nearby National Parks and other areas with high biodiversity value. Finally, mountain ecosystems are the most susceptible on the earth to climate change over the next 50-90 years. Implementing sustainable and climate-smart conservation for the benefit of biodiversity and people alike is of utmost importance (Mutanga and Vengesayi, 2015).

Unluckily, Ethiopia's ability for conservation management is one of the least in the world after decades of underinvestment by the international community and Government alike. The Ethiopian Wildlife Authority's budget for PAs is the third least internationally (just 0.5% of the average) and is 3% of that took necessary for effective management. However, in current years the relationship between the environment and poverty are, becoming higher profile and this has elevated the environment up the political agenda. In addition, there is a substantial increase in political will for biodiversity conservation (Chanie and Tesfaye, 2015). In APA, the following challenges are among the frequently occurred.

### 1.5.1 Local community -wildlife conflict

The majority of the local community members living within and around APA are farmers and mainly dependent on subsistence farming and livestock keeping. Because of their farmland and grazing land found closely in the habitats of wild animals living within APA massive crop destruction and livestock predations are the most common local community-wild life conflicts. The crop damages were mostly by monkeys and apes whereas the livestock predations were by foxes.

Indeed, APA conservation has many purposes, but crop destruction and livestock predation become common local community-wildlife conflicts. Moreover, the absence of or inefficient implementation policy, which fails to maintain the economic compensation for their fair market value is an additional challenge in the conservation of APA.

Conflicts in the use of natural resources among the community living nearby to the PA and tourism development have increased in the current years, because of changes in land use and associated new concepts about wildlife resource management and utilization. Human-wildlife conflict is a major concern of most people living next to protected areas in developing countries due to their subsistent live (Reddy and Workneh, 2014).

Human wildlife challenges start when livestock try to win food and water against the will of wildlife. Livestock herding and agriculture is the main source of revenue and livelihood in

undeveloped countries, human-wildlife conflict is more common in the region for natural resource consumption, which brought wildlife under severe threat. (Woyesa, 2016).

Human-wildlife conflicts have been more intense in recent decades, because of exponential human population growth and economic activities. The highest degree of conflicts tends to occur where humans live nearby to PAs and crop damage is the most predominant form of human-wildlife conflict across the country (Hansilo and Tiki, 2017).

In Ethiopia, the majority of whose farming activities are poor, local subsistence farming communities, and in some cases, commercial farms nearby to wildlife habitats often impacted by the existence and abundance of wild pest animal species. Crop destruction is a rising cause of economic loss and local frustration in subsistence farming settings and also inspires negative attitudes towards species of conservation value. In Ethiopia, different PAs face several challenges because of the rising populations, border conflicts, and recurring drought. Many people in Ethiopia are rural, who needs access to grazing lands (Teshome and Girmay, 2017).

### 1.5.2 Conflict between the APA management and local community

Protected area involves a conflict of interests and international outlooks among different entities. In addition, the consistency of competing interests over the territory at local, regional and national levels, there are apparent evidences of divergence in international views on the approaches to conservation and viewpoints on development.

The demand of the local community members to use the APA resources increased, but in the reverse, the APA resources diminished from time to time. Because of this, the needs of the local community and the conservations of APA are becoming opposite each other for. Inadequate of income for their livelihoods enforce the local community to expand farmland, grazing land, extractions of construction materials and fuelwoods. This led to overexploitation of the natural resources led to deforestations, degradation, frequent drought, etc. On the other hand, the APA management aims to conserve the resources by imposing restrictions against the free access of the local community. These situations led to conflict between the APA management and local community.

According to (Abelieneh, 2017), the establishment of the park significantly affects the local peoples' livelihoods and makes a critical challenge for the park administrators and other local government bodies and vice versa in case of the Alatish national park. Thus, unless the government



bodies reconsider the issue in the park planning and administration process and then make some adjustments, which are important for the biodiversity conservation and well-being of the local people, both the park sustainability and livelihood sustainability will be greatly at risk.

1.5.2.1 Resources utilization and conflict

According to respondents' the local community directly or indirectly dependent on the dependent on APA resources, which caused to the conflicts between APA management staff and the local community. According to the APA manager, all of the surrounding residents of the APA were farmers and low level of income. Again, all residents have no distinct land for their livestock. Therefore, they satisfy their livelihood fully or partially dependent on the use of APA resource table (3-2).

Further, focus group discussions and individual interviews revealed that the conflicts often faced were mainly two types. The first was a minor conflict between APA resource users with the regard to the use of APA resource products. Regards to this, some informants specified that they were disappointed because of the restoration imposed over the previous unlimited access. This unfriendly feeling exaggerates and create problems on the APA management. The second one were associated with the border demarcation. At the time of field observation, the APA located closely with the majority of the local community. During the border, the demarcation process suitable farmland, which is found inside or near the APA and the massive grazing land included into the side of the APA. The local community was practiced in using these resources from the APA.

The majority of the local community and the APA staff were agreed that the conflicts between the APA and local community has decreased during the rainy season and this was mainly due to a reduction of the firing and hunting, availability of sufficient amount of forage sources for the animals and government interferences settle the problems. In addition, most respondents have agreed that community elders, religious leaders, respected individuals and government bodies managed conflicts. This is similar to earlier reports that the inter-clan and community conflict can often be solved using traditional and social organizations. The same authors further suggested that traditional and institutions have a key role to play in resolving conflicts, the management of natural resources and to maintain peace between local community and protected areas.

Respondents were asked about their dependency on APA resources and their understanding of its conservation. Fully dependent and partly depend were mentioned 21.33%, 59.67% respectively by the respondents. However, the 9.8% were unaware of why the government established the APA Table (3-2). However, the 19% were not all dependent on APA resources.

In general, 81 % of the respondents were dependent on APA resources without considerable difference between the two aged groups. However, 19% respondents were not at all dependency on APA resources. Respondents age group 39-59 years, 32.46% dependent on APA resources, and their responses were shared by 31.47% of aging group 18-38, whereas 17.77% of respondents were dependent on aged group >=60.

**Table 0-2 Dependency on APA resources**

Dependency on APA resources	N (305)	Age group			Total
		18-38	39-59	>=60	
Fully depend	65	7.54%	10.49%	3.28%	21.33%
Partly depend	182	23.93%	21.97%	13.77%	59.67%
Not at all	58	11.15%	5.25%	2.6%	19%

The local community described that access to the natural resources such as construction wood, fuel wood and others before and after the establishment of the PA. However, access to the grass found to be better after the establishment of the

APA Table (3-3 & 3-4). Respondents were responding easy, medium, and difficult and neutral based on their accessibility to use the specified natural resources before and after the establishments of the APA.





**Table 0-3 Responses of local community towards access NR to before the establishment of the PA.**

Natural resources	Accessibility to use	N (305)	Age group			Total
			18-38	39-59	>=60	
Construction wood	Easy	138	23.8%	14.3%	7.1%	45.2%
	Medium	88	12.3%	12.1%	4.5%	28.9%
	Difficulty	49	2%	7.8%	6.3%	16.1%
	Neutral	30	4.5%	3.5%	1.8%	9.8%
Fuelwood	Easy	131	17.8%	13.9%	11.1%	42.8%
	Medium	92	13.7%	11.8%	4.6%	30.1%
	Difficulty	43	7.3%	5.7%	1.1%	14.1%
	Neutral	39	3.8%	6.3%	2.9%	13%
Grass	Easy	200	29.4%	23.8%	12.3%	65.5%
	Medium	81	8.5%	12.3%	5.9%	26.7%
	Difficult	-	-	-	-	-
	Neutral	24	4.7%	1.6%	1.5%	7.8%
Others	Easy	165	22.8%	19.6%	11.7%	54.1%
	Medium	108	13.5%	15.9%	5.9%	35.3%
	Difficult	22	5.1%	-	2.1%	7.2%
	Neutral	10	1.2%	2.2%	-	3.4%

**Table 0-4 Responses of local community towards access NR to after the establishment of the PA**

Natural resources	accessibility to use	N (305)	Age group			Total
			18-38	39-59	>=60	
Construction wood	Easy	-	-	-	-	-
	Medium	115	12.9%	18.3%	6.3%	37.5%
	Difficulty	160	26.3%	14.6%	11.7%	52.6%
	Neutral	30	3.4%	4.8%	1.7%	9.9%
Fuelwood	Easy	-	-	-	-	-
	Medium	183	26.4%	23.9%	9.7%	60%
	Difficulty	122	16.2%	13.8%	10%	40%
	Neutral	-	-	-	-	-
Grass	Easy	38	7.8%	4.4%	2.1%	12.3%
	Medium	108	16.7%	13.9%	4.9%	35.5%
	Difficult	149	14.7%	21.4%	12.7%	48.8%
	Neutral	10	3.4%	-	-	3.4%
Others	Easy	77	11.2%	9.1%	4.9%	25.2%
	Medium	84	17.8%	7.9%	1.9%	27.6%
	Difficult	136	13.6%	18%	12.9%	44.5%
	Neutral	8	-	2.7%	-	2.7%

1.5.2.2 Conflict over the use of APA resources had not conflict over the use of APA resources Table Respondents were asked about their conflict over the use of APA resources and their understanding of its conservation. Often and sometimes were mentioned 32.13% and 60.33% respectively by the respondents. However, the 7.54% (3-6).



**Table 0-5 Respondents view on the conflict over the use of APA resources**

Conflict over the use of APA resources	N (305)	Age group			Total
		18-38	39-59	>=60	
Often	98	14.75%	13.44%	3.9%	32.13%
Sometimes	184	25.57%	20.66%	14.1%	60.33%
No	23	2.3%	3.6%	1.64%	7.54%

### 1.5.3 Inadequate Coordination among Stakeholders

The main stakeholders associated with APA are local community, Zone and Regional Administration, the Federal government, EWCA, NGOs and other Educational Institutions. Coordination among the stakeholders and associated entities in APA are very weak. The weakness starts from the lowest APA administration levels extends to the top of the federal government structures.

Absence of a single administrative body taking responsibility for the APA administrations negatively influences its conservation. From the Federal level Environment Forest and Climate Change Commission, Ministry of agriculture & natural resource, and ministry of culture & tourism whereas at regional levels, the Amhara regional agricultural office and natural resources protection officials overlaps their mandates regarding implementing and administering protected areas. Because of this, there is no a single responsible governmental system, taking responsibility in PA administration. The common activities such as planting seedlings, constructions of watersheds etc., were performed by temporary delegates, which could low and weak implementation power. In addition, because of the absence of consistent conservation strategies, timely considering local community rights and benefits failed to manage the concerned stakeholders and local community together. Hence, to make sure the sustainable conservations of APA suitable conservation strategies and responsible government structure as well as to be considered the wills and aspirations of the local community is critically important.

According to (Woyesa, 2016) the opposing attitudes in NNP primarily about the size of the park, the fate of the community, the legal status of the park boundary and the conservation scheme to implement both states in a difficult state to negotiation and place the park in difficult situation to achieve conservation objectives. Conservation without the permission and participation of communities affected by the APA establishment in the Sede Muja district deceased sense of ownership and made negative perception

towards any change of government to succeed in the conservation effort.

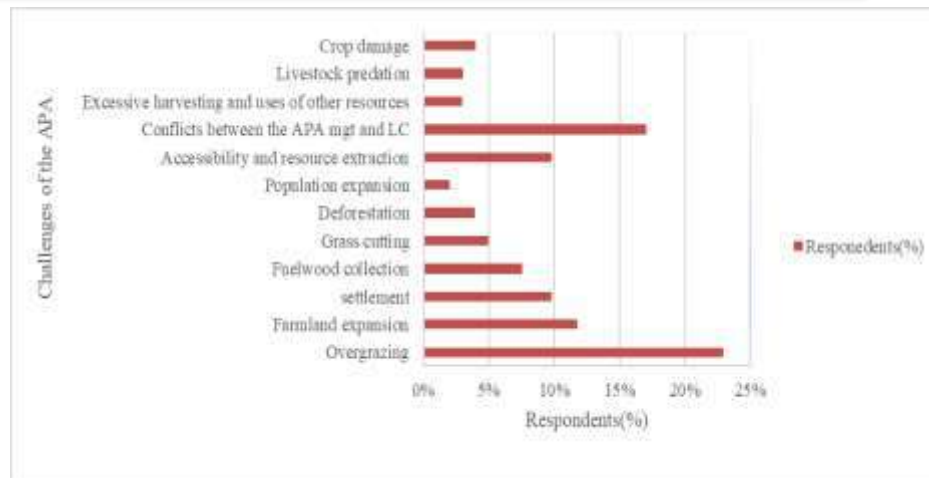
### 1.5.4 Challenges and threats of APA

The The common conservation problems of the APA as mentioned by the majority of the respondents were overgrazing, farmland expansion, settlement, fuelwood collection, grass cutting, deforestation, population expansion, accessibility & resource extraction, conflicts between the APA management(mgt) & local community( LC), excessive harvesting and uses of other resources, livestock predation, and crop damage. These problems caused to the soil erosion, vegetation degradation, wildlife depletion and deforestation.

Indeed, APA conservation has many purposes, but crop destruction and livestock predation become common local community-wildlife conflicts. Moreover, absence of or inefficient implementation policy, which fails to maintain the economic compensation with their fair market value is an additional challenge in the conservation of APA.

According to the respondents in addition to conservation problems of natural resources, lack of clean drinking water, lack of communication, inadequate livelihood and insufficient income are the main problems of the local community in and around the APA. The poor people in rural areas depend directly on natural resources, which might lead to the loss of these resources (Brodnig, 2006).

Local communities present that basic social provisions such as electricity, roads and drinking water supplies are either missing or inadequate in PA as the most pressing challenges. They reported that GO's/NGOs seeking to provide social provisions to the community were prevented by the park management with claims that it is not allowed to establish or expand social provisions in a national park's territory (Astella, 2013). Lack of electricity, roads and water supplies prompts the people to opt for other means of acquiring or supplementing livelihood that are still against the park's rules and regulations (Astella, 2013). Fig (3-2) illustrates the major challenges of the APA as preceding the respondents.



**Figure 0-1 Major challenges of the APA**

Identifying both the potential opportunities and serious challenges are important to take important measures and considering the factors in initiating and implementing sustainable conservation strategies. In addition, creating awareness, teaching purpose of establishment & conservation objectives, giving sufficient compensation for those injured individuals at the right time, implementing sustainable management strategies, initiating incentives and making partnership, and introduce alternative income methods are important for the sustainable coexistence of both the local community and APA.

Therefore, the local community -wildlife conflict, the conflict between the APA management & local community, inadequate coordination among stakeholders, and challenges & threats of APA were the main challenges of APA conservation. Hence, the APA management should consider these critical challenges in their initiating and implementing conservation management strategies to make sure the coexistence of both APA and the local community. This may help create sense of ownership on the part of the communities settled surrounding the APA. Moreover, this may help mitigate the conflicts that could happen between the interest of the local community and the PA.

## CONCLUSION AND RECOMMENDATION

The study was conducted on Ambatara Protected Area (APA). APA is recently established PA in Ethiopia, which is located in Sede Muja district, South Gondar zone, northwest Ethiopia. The study investigated and identified the opportunities and challenges of Ambatara protected Area, Sede Muja District, Ethiopia.

Establishment of community-based PA management in Ethiopia, proclamation and regulations of wildlife managements of Ethiopia, and natural recoverability of the area were its potential opportunities whereas, local community -wildlife conflict, conflict between the APA management & local community, inadequate coordination among stakeholders, and challenges & threats of APA were the major challenges of APA conservation. Moreover, because of the human interference the natural resources base of the APA has been overexploited and exposing numerous challenges. Expansion of local community settlement, farmland expansion, excessive grazing, deforestation, natural resources extraction, poor land management technique directly threatens the existence of APA. The majority of respondents had generally partly depend on APA resources, but few residents are still extracting natural resources illegally, farmland expansion, and grazing land, etc., which are the most critical challenges.

Respondents were responding easy, medium, and difficult and neutral based on their accessibility to use the specified natural resources before and after the establishments of the APA. Indeed, APA conservation has many purposes, but crop destruction and livestock predation become common local community-wildlife conflicts. Moreover, absence of or inefficient implementation policy, which fails to maintain the economic compensation with their fair market value is an additional challenge in the conservation of APA.

Generally, the APA management and other concerned body should identify and utilize potential opportunities to make sure the coexistence of both APA and the local community. On the other hand, identifying and understanding the main challenges of the threats APA and as well as the problems of the



local community is critical to protect from destruction and safely conserve the APA with maintaining the benefits of the local community without affecting the sustainability of the resource uses.

In general, the APA management should be initiating and implementing suitable conservation strategies considering the opportunities to make the sustainable conservations of the APA with satisfying the aspirations of the local community to make sure the coexistence of the APA and the local community. Similarly, the local community -wildlife conflict, the conflict between the APA management & local community, inadequate coordination among stakeholders, and challenges & threats of APA were the main challenges of APA conservation. Hence, the APA management should consider these critical challenges in its initiating and implementing conservation management strategies to make sure the coexistence of both APA and the local community.

## REFERENCES

1. Assefa Abelieneh, Genanew Agitew and Kibrom Adino. (2017). *Impacts and Prospects Of Alatish National Park For Local Livelihoods Sustainability; North Western, Ethiopia*.
2. Astella, B. (2013). *Multiple Enactments of Abijata Shalla Lakes National Park, Ethiopia*.
3. Biodiversity Indicators Development National TaskForce. (2010). *Ethiopia: Overview of Selected Biodiversity Indicators*. Addis Ababa. Pp. 48.
4. Birhan, M. & Gebreyes, G. (2015). *Economic Contribution of Wildlife Management and Ecotourism in Ethiopia*. , 6(5). *Veterinary Science & Technology Review on Problems , Prospects and*.
5. Brodnig, G. (2006). *Biodiversity Conservation and the Millennium Development Goals: Toward Sustainable Development*. *Regional Development Dialogue*.
6. Chanie, S. and Tesfaye, D. (2015). *Threats of biodiversity conservation and ecotourism activities in Nechsar National Park, Ethiopia*. , 7(2), pp.130–139.
7. CSA. (2012a). *Agricultural sample survey 2011/2012, Volume IV: Report On Land Utilization, Central Statistical Agency, Addis Ababa, Ethiopia (2012)*.
8. Danijela A. (2016). *Evaluation of Protected Area Management Effectiveness – An Overview*.
9. De Vos, A.S., Strydom, H., Fouché, C.B., & Delpont, C.S.L. (2011). *Research at grassroots (4th ed.)*. Pretoria: Van Schaik.
10. Dudley, N. (ed.) . (2008). *Guidelines for applying protected area management categories*. IUCN, Gland, Switzerland.
11. Eshetu, A.A. (2014). *Forest resource management systems in Ethiopia : Historical perspective*.
12. Federal Democratic Republic of Ethiopia (FDRE). (2005). *Rural Land Administration and Land Use Proclamation, Proclamation No. 456/2005*. *Negarit Gazeta*. Year 11, No. 44.
13. Federal Democratic Republic of Ethiopia( FDRE). (2008). *Proclamation Number 541/2007 development, conservation and utilization of wildlife and regulation No 163/2008*.
14. Federation, E. (2010). *Following Nature’s design, promoting cross-border cooperation in nature conservation*.
15. Getahun Shanko Mamo. (2017). *Review on Challenges and Opportunities of Protected Area Management in Ethiopia*.
16. Getahun, B.T. and Yesanew, Y.A. (2016). *Sustainable ecotourism potentials and its challenges in Ethiopia: The Awash National Park in Focus*. . *International Journal of Humanities and Social Science Research*, 2(4), pp.2455–2070.
17. Hansilo, D.D. and Tiki, L. (2017). *Challenges of human settlement on wildlife in Bale Mountains National Park ,Southeast Ethiopia*.
18. Hillman JC, . (1993). *Ethiopia: Compendium of wildlife conservation information*. Vol.2. NYZS and EWCO, Addis Ababa, Ethiopia. p. 580. Vol.2.
19. Infield M & Namara A. (2001). *Community attitudes and behavior towards conservation: an assessment of community conservation program around Lake Mburo National Park, Uganda*. *Oryx* 35(1):48-60. <http://dx.doi.org/10.1017/S0030605300031537>.
20. Israel GD. (2012). *Determining Sample Size, Agricultural Education and Communication Department, Florida Cooperative Extension Service, Institute of Food and Agricultural Sciences, University of Florida*.



21. IUCN. (1993). *Parks for life. Report of the IVth World Congress on National Parks and Protected Areas*, pp 252.
22. Kothari, C.R. (2004). *Research Methodology: Methods and Techniques, second ed. New Age International, New Delhi, India.*
23. Mitchell, K. and Branigan, P. (2000). *Using focus groups to evaluate health promotion interventions. Health Education 100:261-268.*
24. Mulualem, A.G. and Tesfahunegny, W. (2016). *Review of Key Wildlife Threats Factors from Literature and Observation Perspectives: A Way Forward for Sustainable Wildlife Genetic Resource Conservation Practices in Ethiopia. , 3(5), pp.1-12.*
25. Mutanga, C.N. and Vengesayi, S. ( 2015). *Community perceptions of wildlife conservation and tourism : A case study of communities adjacent to four protected areas in Zimbabwe. .*
26. Oldekop, J.A., Holmes, G., Harris, W.E., Evans, K.L. (2016). *A global assessment of the social and conservation outcomes of protected areas. Conserv.Biol. 30(1), 133e141.*
27. Reader, J. (1999). *Africa, A Biography of the Continent, Random House Inc.*
28. Reddy, R.U. & Workneh, S. (2014). *Conflicts between the conservation of Elephant and Human activities : In the case of Babile Elephant Sanctuary ( BES ), Ethiopia..pp.25-29.*
29. Reddy, R.U. and Workneh, S. (2014). *Conflicts between the conservation of Elephant and Human activities : In the case of Babile Elephant Sanctuary ( BES ), Ethiopia.*
30. Snyman, S. (2013). *High-end ecotourism and rural communities in southern Africa: a socio-economic analysis. Unpublished PhD. thesis. University of Cape Town: School of Economics.*
31. Snyman, S.L. (2014). *Assessment of the main factors impacting community members' attitudes towards tourism and protected areas in six southern African countries. Koedoe, 56(2), 1-12.*
32. Steffen, W., Persson, A., Deutsch, L., Zalasiewicz, J., Williams, M., Richardson, K., Crumley, C., Crutzen, P., Folke, C., Gordon, L., Molina, M., Ramanathan, V., Rockström, J., Scheffer, M., Schellnhuber, H.J. & Svedin, U. ( 2011). *The Anthropocene: from global challenge to planetary stewardship. Ambio, 40, 739-761.*
33. Teferra, F. & Beyene, F. ( 2014). *Indigenous claims and conflicts in managing the Abijata-Shalla Lakes National Park , Ethiopia. International Journal of Biodiversity Science, Ecosystem Services & Management, 10(3),.*
34. Teshome, and Z. Girmay,. (2017). *Human-Wildlife Conflict : Challenge and Management in Ethiopia : A. , 89, pp.5004-5009.*
35. Trakolis, D. (2001). *Local people's perceptions of planning and management issues in Prespes Lakes National Park, Greece. Environmental Management, Vol. 61, pp227-241.*
36. Woyesa T. (2016). *Retrospect and Prospects of Combining Conservation and Development in Nechsar National Park, Southern Ethiopia. Intel Prop Rights. 4: 169.*



# EVALUATION OF INNOVATION CAPACITY RESOURCE COMPONENTS IN EFFECTIVE MANAGEMENT OF RECREATIONAL CLUSTERS ON THE BASIS OF ECONOMETRIC ANALYSIS

**Mirzaev Abdullajon Topilovich**

*Senior teacher of the Ferghana Politechnical Institute, PhD 150100, Ferghana street 86,  
Ferghana city, Uzbekistan*

Article DOI: <https://doi.org/10.36713/epra4790>

## ABSTRACT

*The article examines the methodology for assessing the resource component of the innovation potential of clusters in the field of recreational tourism, which in recent years has been able to develop the national economy at a rapid pace. In the process of the research, developed the authorship definition on the basis of a theoretical study of the terms “innovation potential of the tourist recreation subject (TRS)” and “innovation potential of the tourist recreation clusters (TRK)”, which are considered the main link of the tourist recreation cluster. The method of assessing the resource component of the innovation capacity of the clusters in the recreational tourism sector was improved by using a model based on the modified production function of Cobb-Douglas as a research innovation.*

*Theoretical research is based on the determination of the forecast indicators for the year 2022 in the Republic of Uzbekistan through the econometric model in the linkage of factors affecting the volume of recreation services rendered for 2013-2019 years.*

**KEYWORDS:** *tourism, recreational tourism, recreational clusters, management of recreational clusters, innovation potential, resource component, innovation potential of the recreational subject, innovation potential of the recreational clusters, the resource base indicators.*

## INTRODUCTION

In recent years, in the process of economic development of the countries the development of individual sectors on the basis of a cluster approach requires research into the current state of affairs. Taking into account this, the formation of recreational service clusters, which are one of the effective directions of the organization of recreational activities in the regions, and the development of the market of services on the basis of their management is recognized as a promising direction.

Today, the tourism industry is becoming one of the leading sectors of the world economy. In this regard, special attention is paid to modernization of the tourism sector in Uzbekistan, improvement of the base of normative-legal documents for the sustainable development of the sector, provision of services in accordance with international standards. The role of tourism, which is now one of the important sectors of the

economy, is very significant. The development of the tourism industry is associated with the complication of production, the replenishment of the consumer market with goods due to daily and personal demand, the rapid growth of scientific and technological progress that refreshes the life of society. All this can not be done without information, financial, transport, consulting and other types of services.

Today, on account of the development of domestic tourism on a global scale, Uzbekistan is also creating extensive conditions for the restoration of the declining tourist flow in the market of tourism services. This puts the population on the agenda of increasing demand for recreational services and the issue of forming an effective offer of these services. Taking into account the above, improved the theoretical and practical method of formation of the





resource component of innovation capacity in the management of recreational clusters.

## LITERATURE ANALYSIS

Even in foreign literature, which reflected the results of various studies, there is no unanimous opinion on recreational system and some concepts related to it. The reason for this – the definition of the concepts of recreation and recreational activity, and boundaries of its activity is a complex process. The absence of a single interpretation of the terms, the existence of different approaches and concepts in different countries, the lack of information in the legislation on the concept of recreation, the possibility of obtaining accurate information on recreation reduce the possibility of carrying out research on a large scale.

On the base of the theoretical research as one of the results developed author's definition of the terms “innovation potential of the recreational subject” and “innovation potential of the recreational clusters”, which are relevant for the fact that it is one of the most important and necessary concepts in the management of tourist-recreational activities.

A.V.Drozdov notes that since these terms do not have a clear definition yet, there are objections and sub-approaches in its meaning [1].

Researches I.V.Zorin, V.S.Kvartalnov, L.G.Lukyanova and N.A.Kamenskih cited that the term innovation capacity can be used in the innovation activities of the recreational subject from natural, anthropogen and regional resources in order to meet the needs of tourists [2, 3].

By A. Mirzaev studied the problems of assessing the processes of organization and management of recreational activities, the analysis of factors affecting the recreational facilities of the regions, the improvement of the integral assessment of recreational facilities [4, 5, 6, 7], and G.Khonkeldieva investigated the organizational and economic dimensions of management of investment activities, improvement of management processes in corporate governance systems based on the mechanism of Public-Private Partnership (PPP) [8, 9, 12]. The researches of A.Asrakulov studied theoretical and practical aspects regression link [10, 11].

As can be seen from the above, factor analysis of the impact of the innovation potential of tourist recreation clusters on the volume of cluster services of the resource component is not sufficiently reflected in the research of foreign and domestic scientists. Taking into account the above, in this research developed recommendations for improving the methodology for assessing the resource component of innovation capacity in the management

of recreational clusters on the basis of a theoretical study.

## METHODOLOGY

In the research on the basis of monographic research studied theoretical aspects the evaluation of the resource component of innovation capacity in the management of recreational clusters. Based on official statistics, and by using EViews10 analysis software, determined the volume of recreation services, which are considered the main indicator and the resource component indicators affecting it, evaluated the econometric model, the trends of changes in the main parameter based on the time series, and determined the forecast indicators for the short-term period.

In the process of carrying out the research, used methods of scientific abstraction, correlation-regression analysis, analysis and synthesis.

## RESULTS

In the structure of the innovation potential of the recreational subject, support for infrastructure resources occupies a special place. The composition of this resource should include the following:

- information support from organizational point of view;
- economic, financial and legal consulting services;
- communication systems;
- consulting services in marketing and advertising.

It is desirable to group the resource indicators used in recreational activities as follows:

- sources supporting scientific activities;
- material resources;
- institutional resources;
- investment resources.

Complex system development is required to assess the resource component of the innovation potential of the recreational cluster resources:

- formulate strategies and objectives for the innovation policy of the cluster, including the policies and strategies of the region in the field of recreational tourism development;
- build a database for quality management decisions;
- analysis and statistical calculations, as well as an international comparison of the existing results of an interregional or tourist-recreational entity;
- attracting interested parties (potential consumers, suppliers, service providers, the public, etc.) to the activities of the recreational entity.

Comprehensive evaluation of the resource component of the innovation capacity of tourist-recreation clusters should be carried out using



economic evaluation tools and methods that allow to select comparable indicators. The resource component can be determined on the basis of the quantitative value of the innovation potential, the use of the services of the tourist-recreational subject in historical and cultural areas, the environment, the quality of recreation.

In order to develop a system of indicators for the resource component of innovation capacity, it is necessary to take into account, in addition to the information base, statistics of the data service and reports of business entities, as well as existing official data, institutional aspects affecting the innovation potential of the tourist recreation entity.

In our opinion, the resource component tourist-recreation services complex is the maximum value of the innovation potential that can be used to evaluate the current innovation activity, while the cluster service is determined by the maximum number of consumers.

This volume is formed by the number of places of residence of tourists, the volume of food, the number of local entrepreneurs serving tourists, the human resources involved in the cluster, information resources, financial resources, infrastructure resources and transport resources.

Apparently, to the development of the general potential of the tourist-recreation clusters affects its scientific and innovative, investment potential and institutional indicators.

The volume of services provided by the tourist-recreation cluster can be characterized by the modified function of producing one-factor Cobb-Douglas.

$$V = P \cdot Q^a$$

There are:

$V$  - volume of services provided by the tourist-recreation cluster;

$P$  - the cost of services created on a unit resource account;

$Q$  - resource size indicator;

$a$  - depreciation coefficient, the share of the factor of production over a period of time.

The determination of the resource component of innovation capacity using this system of indicators is theoretically a new method in determining and assessing the volume of recreational activities in our country, and the introduction of this method into practice allows effective organization of tourist recreation activities in tourist-recreation clusters.

The planning and modeling of the management of tourist-recreation activities on the basis of the method of determining the resource component of the innovation potential, analyzed theoretically above, determines the strategy of the management at a high level.

Modeling of the dynamics of the main indicators of tourist-recreational activities in the Uzbekistan can be carried out with the help of models in the form of trends, and time series in the field.

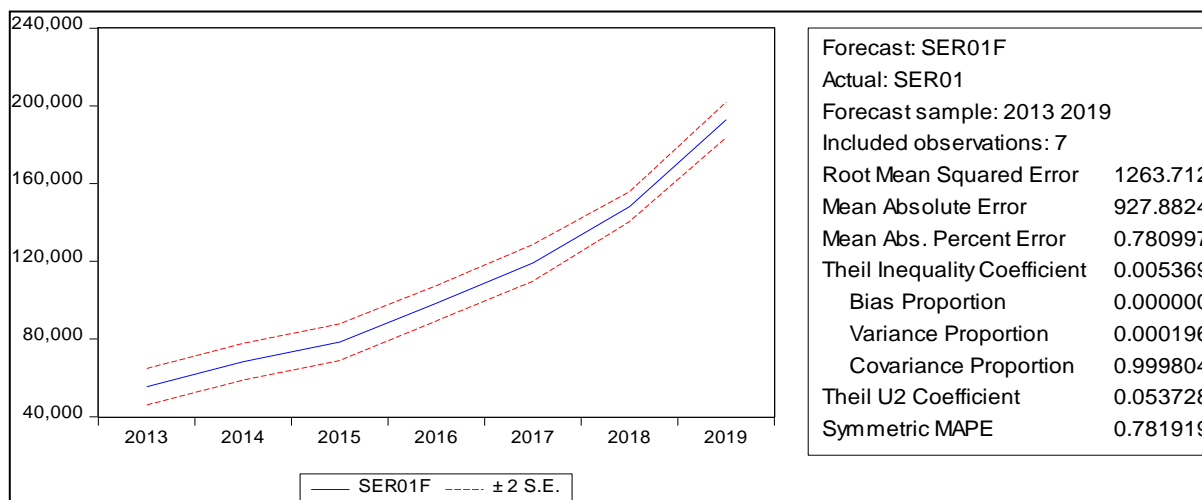
**Table 2**

**The main indicators of tourist-recreational activities in Uzbekistan**

No	Indicators	2013	2014	2015	2016	2017	2018	2019
1	<b>The volume of recreational services (bln. som)</b>	<b>55872,8</b>	<b>68032,1</b>	<b>78530,4</b>	<b>97050</b>	<b>118811</b>	<b>150889,8</b>	<b>191629,8</b>
2	Accommodation and catering services (bln.som)	590,1	729,1	890,6	3038,7	3649,6	4673,3	5984,1
3	Number of sanatoriums	98	103	111	116	119	128	138
4	Number of profiled sanatoriums	55	59	56	62	63	73	84
5	Number of vacation homes, vacation bases and boarding houses	49	53	53	52	59	84	120
6	Number of tourist bases and other recreational facilities	168	172	172	204	219	199	180

Regression analysis showed that the volume of rendered recreational services in Uzbekistan for the years 2013-2019 has a tendency to grow steadily under the influence of factors (Figure 1).

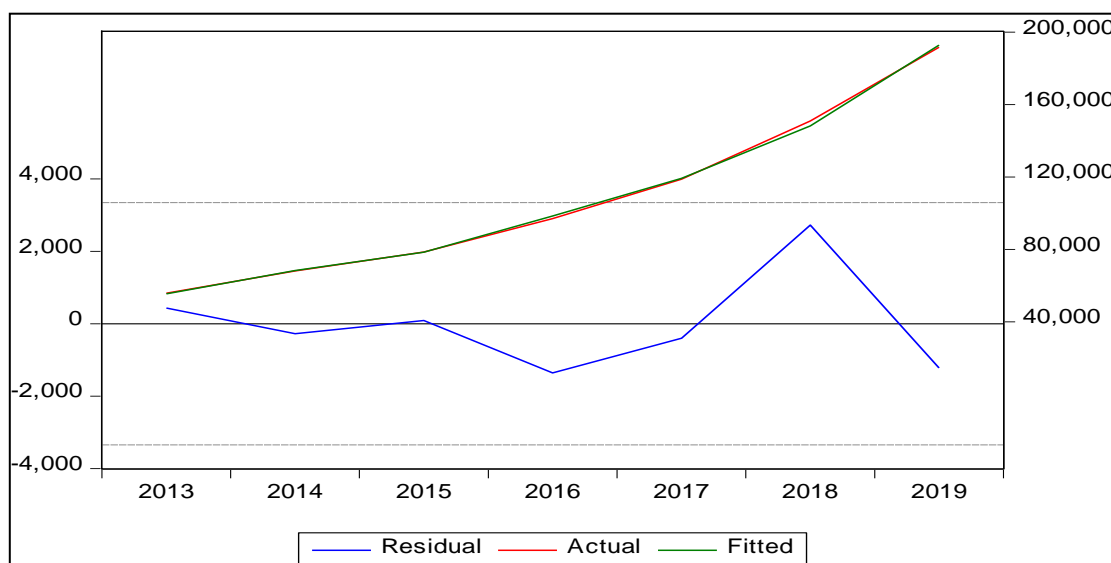
By using the EViews10 program, also evaluated the changes of the main endogen indicator on the residual, real and fitted trends (Figure 2).



**Figure1. The trends of change of the volume of rendered recreational services in Uzbekistan in 2013-2019**

Apparently, the discrepancy between the indicators based on the actual and fitted model is very small, and based on this, it can be noted that the management and coordination of the above 5 main

factors affecting the volume of recreational services indicated in the coming period is important in the sustainable development of the recreational services.



**Figure2. Residual, real and fitted model trends in the volume of rendered recreational services in Uzbekistan in 2013-2019**

Regression analysis revealed that the change in the volume of recreational services as a result changed based on the following regression model:

$$y = -1,27x_1 + 1225,91x_2 - 177,53x_3 + 1313,93x_4 + 592,26x_5 - 218065,5$$

When considering the adequacy of the model, it seems that the quality indicators of the model are as follows:

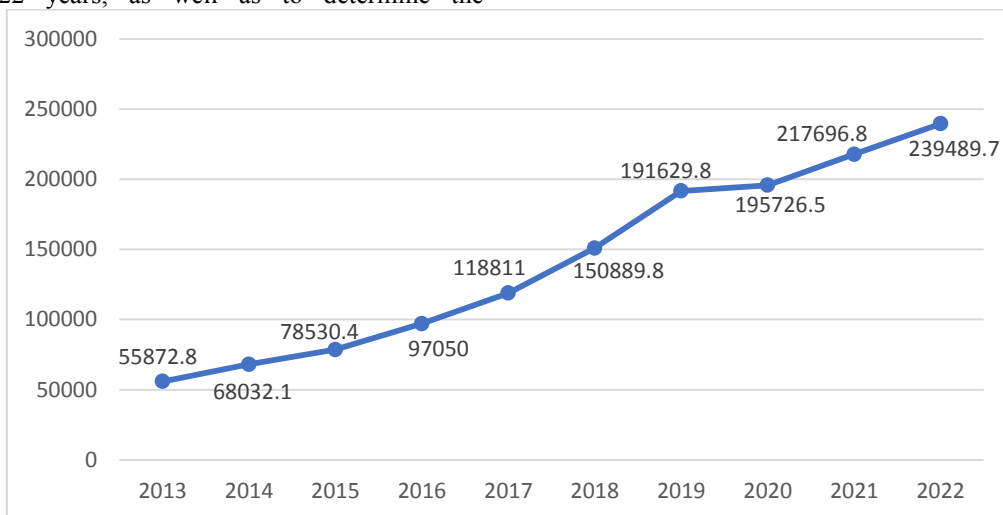
- R-squared ( $R^2$ )	-	0,9992
- S.E. of regression (SE)	-	3343,47



- F-statistic ( $F_{stat.}$ )	-	254,75
- Prob(F-statistic)	-	0,0475
- Schwarz criterion	-	18,79
- Hannan-Quinn criterion	-	18,26
- Durbin-Watson stat	-	2,59

Based on the above model, it is possible to determine the forecast indicators of the volume of recreational services and the factors affecting it for 2020-2022 years, as well as to determine the

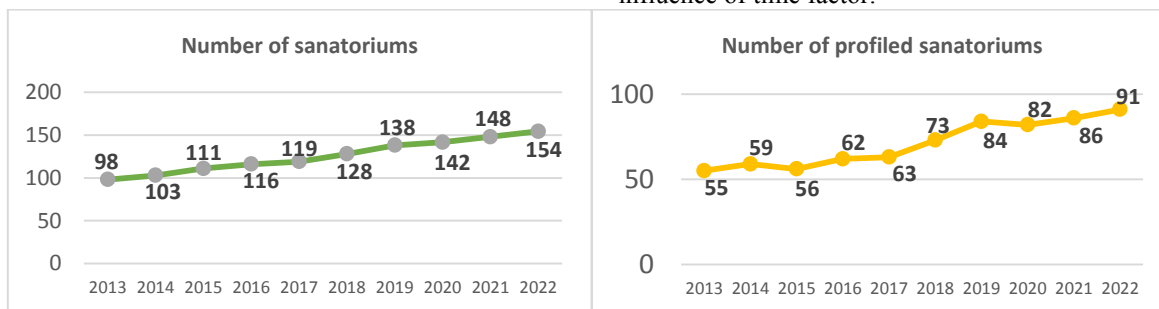
directions of factor management, which affect the achievement of these indicators in the next three years (Figure 3).

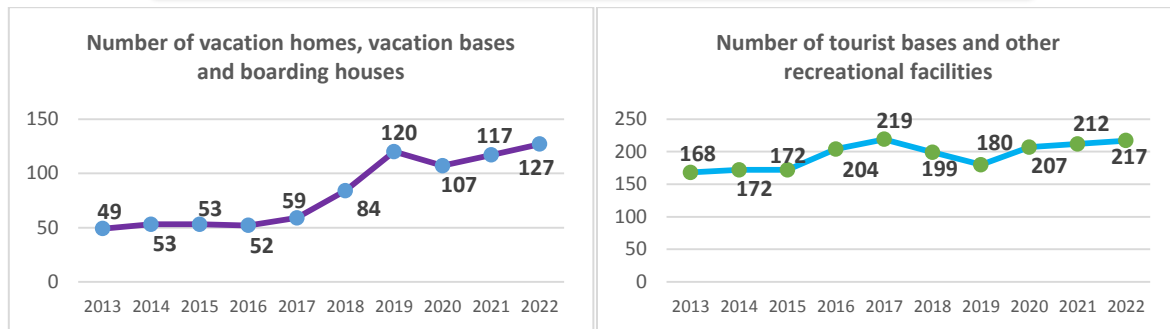


**Figure 3. Changes in the volume of rendered recreational services in Uzbekistan in the period 2013-2022**

As can be seen from the picture, the volume of recreational services on the basis of the identified model and the factor affecting it the forecast indicators of the indicator (resource component) for the years 2020-2022 have a steady growth trend (Figure 4).

The trend of change from the introduction of 4 influencing factor indicators, which are considered as tourist-recreation resource components, in which the units of measurement are the same, to the forecast indicators developed on the model based on the time series in 2013-2019 years, into the time series shows a steady (close to linear linking) growth in the influence of time factor.





**Figure 4. Change of tourist-recreational resource components in 2013-2022**

Based on the analysis, by modeling the innovation potential of the components of tourist recreation resources, the opportunities for identifying the necessary points and supports for the processes of management activity in recreational tourism clusters and sustainable development of clusters on this basis are high.

## RECOMMENDATIONS

Based on the above tasks and practical results, made the following suggestions and recommendations:

- development of a separate structure and long-term strategy of management of the activities of tourist recreation enterprises on the basis of the method of determining the resource component of innovation capacity;

- expansion of the material and technical base of the clusters on the basis of regular and planned attraction of domestic and foreign investments to tourist recreation activities and wide involvement of innovations to the sphere;

- determined trend of change for 2013-2022 years of the main indicators related to tourist recreation activities in Uzbekistan. According to it, the forecast indicators indicate that the volume of services provided by the main types of economic activity can reach a rapid growth trend by 2022 year.

- restoration of tourism clusters in tourist-recreation areas (construction of a complex of tourist facilities covering all areas of tourism in addition to sanatoriums, boarding houses and recreation areas available in all regions of Uzbekistan and through the attraction of domestic and international tourists);

- establish " free tourist zones" in regions, where widely developed tourism clusters;

- increase the attention to recreational tourism by attracting foreign tourists to the recreational areas and resorts.

The development of effective use of the method of application of the resource component of innovation capacity in the recreational clusters in order to maximize the level of use of existing tourist-recreation services on the basis of effective

management and planning of tourist-recreation activities and effective organization of the offer of services further reduces the development period of the sphere. This will be the basis for determining the high saturation point of demand and supply relations in the recreation services market, as well as accelerating the development diffusion of the tourist-recreation services market in the cross-border regions, creating new jobs, ensuring effective employment of the population.

## LITERATURE

1. Лана Е.А. Развитие инновационной активности хозяйствующих субъектов туристско-рекреационной сферы. Диссертация на соискание ученой степени кандидата экономических наук. Самара-2019. Стр-209.
2. Зорин И.В. Энциклопедия туризма / И.В.Зорин, В.А.Квартальнов. –М., 2003. – С. 89.
3. Каменских Н.А. Кластерный подход к управлению развитием региональной туристско-рекреационной подсистемы // Науковедение. – 2016. – Т.8. – №2 (33). – С. 41.
4. Mirzaev, A. T. (2020). Assessment of cluster formation in management of recreational activity. *ISJ Theoretical & Applied Science*, 04 (84), 605-610. <https://dx.doi.org/10.15863/TAS.2020.04.84.1.01>
5. Mirzaev, A.T (2018) "The level of use of tourist attractions in the regions and the factors affecting them," *Economics and Innovative Technologies*: Vol. 2018: No.3,Article19.Available at: <https://uzjournals.edu.uz/igtisodiyot/vol2018/iss3/19>
6. Мирзаев А.Т. Совершенствование интегральной оценки механизма рекреационно-туристических объектов // *Бюллетень науки и практики*. 2019. Т. 5. №2. С. 127-134. <https://doi.org/10.33619/2414-2948/39/17>
7. Mirzaev A. T. ESTIMATION OF THE PROSPECTS FOR THE USE OF RECREATIONAL FACILITIES IN THE





- MARKET OF TOURISM SERVICES //Наука сегодня: вызовы, перспективы и возможности [Текст]. – 2018. – С. 76.*
8. Ханкелдиева Г.Ш. Особенности корпоративного управления в акционерных обществах с государственным участием // Бюллетень науки и практики. Электрон. журн. 2017. №11 (24). С. 357-363. Режим доступа:  
<http://www.bulletennauki.com/honkeldiyeva>
  9. Ханкелдиева Г. Ш. Организационно-экономический механизм управления инвестиционной деятельностью в сфере телекоммуникаций //Экономика и бизнес: теория и практика. – 2019. – №. 11-3.
  10. Асракулов, А. С. (2019). Неформальная занятость и анализ факторов, влияющих на неформальную занятость в Узбекистане. Региональная экономика: теория и практика, 17(12), 2328-2336.
  11. Asrakulov, A. S. (2017). Some aspects of development of the labor market of the Republic of Uzbekistan. Актуальные проблемы социально-гуманитарных наук (pp. 39-42).
  12. Ханкелдиева Г. Ш. Перспективы развития электроэнергетической отрасли Республики Узбекистан в условиях модернизации экономических отношений // Бюллетень науки и практики. Электрон. журн. 2017. №12 (25). С. 293-299. Режим доступа:  
<http://www.bulletennauki.com/honkeldiyeva-g>
  13. Орипов А. А. (2019) Развитие информационно-коммуникационных технологий в Узбекистане. Образование и наука в России и за рубежом, (16).



## THE ROLE OF EUPHEMISMS IN TEACHING

**Feruza Mamatova Bakhtiyorovna**

*National University of Uzbekistan named after Mirzo Ulugbek, 11-29, Janggoh, Shayhontohur district, Tashkent, Uzbekistan.*

### ABSTRACT

*Our study is dedicated to teaching students how to use euphemisms in speech as a means of developing communicative competence. Since modern education puts forward in the first place such personal communicative qualities of students as the ability to avoid communicative conflicts and failures, not to create communicative discomfort in the interlocutor, learning to use euphemisms in the lessons is considered as a methodological problem, the solution of which is aimed at developing students' communicative competence and is based on the use of communicative-activity, systemic and personal approaches. We examined various interpretations of the concept of "euphemism" and came to the conclusion that at the moment there is no single understanding of the concept of "euphemism". There are many approaches to understanding euphemism (euphemism as tropes, periphrases, substitute, etc.), which do not contradict each other, but complement each other. And due to these approaches we can create new techniques and methods of teaching euphemisms. According to these new methods we can organize new lesson materials based on different aspects and skills.*

**KEY WORDS:** *euphemisms, teaching, methods, aspects, vocabulary, principles, interpretation, approach, skill, task.*

### INTRODUCTION

In connection with modernization in the country's economy, significant changes have occurred in the educational system. The public is faced with the problem of quality training of specialists in various fields of activity. In addition to professional knowledge, communicative abilities are put in the first place, that is, the ability to ensure the correctness of communication, since communicative correct speech helps harmonize the relations of various racial and ethnic groups, harmonize gender relations, relations of people of different ages, social status, material wealth, etc.

The formation of correct speech by students is possible thanks to teaching them how to use euphemisms in speech in accordance with the speech situation.

Today, euphemistic expressions are used in all socially significant spheres of human life. In oral and written speech, euphemisms perform very important functions: they help to avoid conflict in communication, hide unpleasant phenomena of reality, replace direct names for fear of shocking

others, increase the prestige of unpopular organizations and professions, mask the true essence of the signified.

There are various definitions of euphemisms promoted by scientists in their work. Despite a fairly large number of works addressing the phenomenon of euphemism, in the scientific literature there is no single understanding of this phenomenon. The dynamism and multidimensional nature of euphemisms is the reason for the wide variety of their lexical and grammatical forms, emotional neutrality or stylistic coloring, and the variability of their euphemistic potential.

These properties of euphemisms lead to the fact that the problem of determining euphemism presents a certain difficulty for researchers. So, in the linguistic encyclopedic dictionary, ed. O.S. Akhmanova is given the following definition: "Euphemisms are emotionally neutral words or expressions used instead of words synonymous with them and expressions that seem to the speaker indecent, rude or tactless" (Akhmanova, 1966).

We find a similar definition with the researcher D.N. Shmelev, who characterizes



euphemism as “abstinence from inappropriate words, a softened expression that serves under certain conditions to replace such designations that appear to the speaker to be undesirable, not quite polite, too harsh” (Shmelev, 2002).

The Big Encyclopedic Dictionary “Linguistics” edited by V.N. Yartseva gives the following definition of euphemism: “euphemisms are emotionally neutral words or expressions used instead of words synonymous with them or expressions that seem to the speaker indecent, rude or tactless (Yartseva, 1990). They also replace taboo names, archaic. Euphemisms also mean occasional individual-contextual substitutions of one word for another with the aim of distorting or disguising the true essence of the signified.”

Another scientist D.E. Rosenthal gives approximately the same interpretation of euphemism, calling it “a softening designation of an object or phenomenon, a milder expression instead of a rude one” (Rosenthal, 1987).

I.R. Halperin believes that euphemism is “a word or phrase that is used to replace an unpleasant word or expression with a relatively more acceptable one” (Halperin, 1981).

According to A. Katsev, euphemisms are indirect substitutes for the terrible, shameful or odious names that contribute to the mitigation effect, brought to life by moral or religious motives (Katsev, 1977).

E.E. Tyurina notes that “euphemisms are soft and permissible, meliorative-allegorical, and sometimes simply more acceptable for one reason or another, words or expressions used instead of thematically stigmatic or socially incorrect antecedents, instead of words or expressions that seem forbidden to the speaker indecent, unacceptable from the point of view of moral standards accepted in society, or even simply rude and tactless” (Tyurina, 1998).

In the Russian language dictionary edited by A.A. Evgenyeva is written: “Euphemism is a word or expression used instead of another, which for some reason is inconvenient or undesirable to pronounce” (Evgenyeva, 1984). The definition reflects the most general idea of euphemisms, the part in which linguists are unanimous. Such a streamlined definition does not clarify anything. For example, are linguistic substitutions of a reduced style of speech related to euphemisms? Should euphemisms be considered replacements for units with a positive denotation (addressee, name of beloved / beloved, name of God, etc.)?

And one of the last interpretations of euphemism is found by the researcher L.P. Krisin, defining euphemism as “a way of indirect, peripheral

and, at the same time, softening the designation of an object, property or action ...” (Krisin, 2004).

Euphemisms - an ambiguous phenomenon, causing controversy among scientists about their interpretation, signs and functions. But, summarizing the views of researchers, we can present euphemism as a neutral expression in meaning, used to replace indecent or tactless lexemes.

Also in Uzbek linguistics there are some ideas about taboos and euphemisms in connection with the study of euphemistic phenomena. This issue has been scientifically studied by Nemat Ismatullaev (Ismatullaev, 1963). In this study, the author was the first to collect a wealth of information about taboos and euphemisms, react to them, summarize and come to scientific and practical conclusions. When N. Ismatullaev speaks about the causes of euphemisms in the Uzbek language, he groups them. For example, euphemisms used instead of the name of poisonous insects (scorpion); euphemisms used instead of the name of wild animals (wolf, bear); euphemisms used in the language of women (do not name the husband by name). He also analyzed the importance of euphemisms in speech and his devotion to enriching vocabulary. Further, this concept was studied by Omonturdiyev. In his dissertation, he revealed the classification of euphemisms and its use in the field of professions (Omonturdiyev, 2006).

After analyzing the scientific works of various researchers, we came to the conclusion that teaching students to use euphemisms in speech is relevant and promising.

All researchers recognize the importance of teaching euphemisms today, which confirms the relevance of our study. For all the variety of scientific directions in the study of euphemisms, the problem of teaching the use of euphemisms in speech, that is, the methodological aspect of the study, which is of paramount importance in our study, remains poorly understood.

Thus, the relevance of the study is due to several factors:

- firstly, the concept of “euphemism” reflects the turn of linguistic and methodological science towards the study of not only the most effective, but also the most correct use of speech means in various communication situations;
- secondly, the principles and methods of teaching students how to use euphemisms in speech have not yet been developed in scientific linguistic and methodological literature;
- thirdly, the practice of working with students allows us to ascertain the inability of students to correctly construct speech



behavior and behave correctly in specific speech situations, which actualizes the problem of teaching students a speech culture, but in a certain context, in the context of teaching students to use euphemisms in speech.

## **MATERIALS AND RESEARCH METHODS**

Learning to use euphemisms in speech is aimed at developing communicative, linguistic, linguistic, cultural and ethical competencies.

Also, teaching euphemization of speech contributes to the improvement of speech skills in various activities: speaking, listening, writing, reading, which corresponds to communicative competence.

The developed exercise system has a gradual nature, which allows you to enter information about

euphemisms in stages, gradually complicating the type of exercise from stage to stage. Therefore, the developed system of exercises has four stages of training, corresponding to the formed skills. First, students get an idea of euphemisms, learn to perceive them in the text, determine the function of euphemisms. Then learn to distinguish euphemism from other means of expression. Then develop the skill of euphemism formation using various methods and means; drawing up your own euphemisms in accordance with the communicative task, editing incorrect texts.

There are four stages of training:

1. Students are divided into groups which consist of 4-6 members. The teacher distributes the text to each group. From the text, students will have to find euphemisms, explain their meaning and what a crude concept they replace.

### **Task 1.**

#### **Fitting In**

When you travel it's important to abide by the local rules and customs. As we say the UK, "When in Rome, do as the Romans do." Many tourists fail to blend in when they go abroad. In fact, they stick out sore thumbs and may even get on people's nerves.

You have to watch your P's and Q's in the UK. If you don't say please and thank you you'll end up ticking people off. You can overstep the mark if you start asking personal questions. You shouldn't brag about your achievements or wealth either. If people may think you're a Flash Harry or a show off they'll give you the cold shoulder.

No-one will bat an eyelid if you burp in China. If you do it in other countries you'll get told off. However you'll fall out with people if you whistle. It's considered rude.

If you want to fit in when you visit Spain you should dress up. The grungy look doesn't go down well over there.

Greetings are another potential minefield. If French people greet each other with two kisses. In the UK and America people are more likely to shake hands.

If you do put your foot in it don't worry. Hopefully your hosts will realise you're foreign and turn a blind eye.



Find the euphemisms from the text and match them with the phrases in the box.

notice
_____
pay no attention
_____
difficult situation
_____
make a faux pas
_____
someone who brags
_____
someone to brags about money
_____
be polite
_____
do the same as the locals
_____
be totally different
_____
go too far
_____
it's not accepted
_____
exclude somebody
_____
annoy somebody
_____

1. *Is there a nearby restroom?*
2. *Katherine, a domestic engineer, had her work quietly received.*
3. *Her doctor informed her that he was fading quickly and that the end was near.*
4. *The policeman was dismissed for personal reasons.*
5. *To increase fiscal positioning, the treasury will make rate adjustment.*
6. *The discussion revolved around cultural issues and unauthorized occupant withdrawal.*
7. *Most penitentiary attendants operated the correctional institution with inhumanness.*

<i>brutality</i>
<i>armed guards</i>
<i>illegal prisoner escapes</i>
<i>toilet</i>
<i>fired</i>
<i>housewife</i>
<i>ignored</i>
<i>he will be dead soon</i>
<i>racism</i>
<i>profits</i>
<i>government</i>
<i>dying</i>
<i>increase taxes</i>
<i>jail</i>





2. Students are divided into groups which consist of 5 members. The teacher distributes dialogues to each group, where rude and incorrect words are used. Students will need to pick up euphemisms for these words and replace them with euphemisms.

## Task 2.

## Dialogue #1.

*Monica and Abby are stretching at the back of the class.*

*Abby: Any luck of finding anything?*

*Monica: No. Not at all. I applied for 128 jobs online, and only got two interviews.*

*Abby: What happened?*

*Monica: One offered me a job in Hong Kong.*

*Abby: That's a pretty crazy. Living in Hong Kong.*

*Monica: That's all they had available so I turned it down. I have my family to think about.*

*Abby: What about the other one?*

*Monica: Yeah that one was a real winner. Not only did they expect me to be an expert, they wanted me to order food for client meetings and serve coffee, do dishes.*

*Abby: I see what you mean. Degrading.*

*Monica: I was supposed to get another four months of unemployment, then this week I get a letter telling me our state doesn't qualify anymore for the federal funding that's paying for it now.*

## Dialogue #2.

*Kalvin, Dutch, Jay and Wally huddle close together and walk down the sidewalk.*

*Dutch: Goddamn, it's cold! What the hell did you make us walk for?*

*Jay: Seriously. I shouldn't have driven.*

*Kalvin: You are in no condition to operate a car.*

*Besides, it's not too much further.*

*Wally: There going to be a lot of drinks at this place, Kal?*

*Kalvin: I don't know. I'd assume so.*

*Jay: Well, your little "Lois Lane" is going to be there. She got any friends or roommates.*

*Kalvin: Hmm. That's a good question.*

*Jay: What do you mean?*

*Kalvin: I don't think I've ever seen her with any friends.*

## Dialogue #3.

*Abby: It sucks. I guess I'm like everyone, doing what they gotta do to survive, and wanting to find something else.*

*Monica: Yeah that's part of the problem.*

*Not only is it the unemployed, but all the people like you applying for the same positions as me.*

*Abby: Don't worry. Forget it all for a while.*

*By the way, where's your friend Chloe?*

*Monica: I didn't call her. I wasn't in the mood.*

*Abby: Now you're talking.*

3. Students are divided into two groups. Each group presents its own theme, which was previously set by the teacher. Students will need to show a polite form of speech using euphemisms. Each group speaks on different topics reveals the area for which they prepared in advance. The subject may be of a different nature:

## Task 3.

*a conversation between the cashier and the buyer, the doctor and the patient; conversation between diplomats, etc.*

4. The teacher gives students a list of euphemisms that are used in the press. Each student will have to write his own article as a reporter, using the appropriate euphemisms by selecting from the list.

## Task 4.

1. "Spending more time with the family" is used as a general statement by politicians who have been forced to resign because of some low-level scandal they don't wish to admit / comment on.

2. "Sometimes.... I park my car in the wrong driveway" Roger Stirling's apology to Don Draper [in US drama Mad Men] for being highly flirtatious with Don's wife while drunk.

3. "Extreme Rendition" A term coined by our "allies" to cover the illegal transportation of foreign nationals (possibly "terrorists") across international borders, illegally.

4. Unfavourite euphemism. "Passed away" or "Lost" as in "I lost my husband". People do neither of these things. They DIE.

5. In the 70s a lot of LSD seemed to be produced in or around Lincoln and it was common when asking what someone was doing at the



*weekend to have them reply "I am going to Lincoln" meaning they were going to be dropping acid.*

6. *My favourite is the phrase "operative statement" which a Nixon White House press secretary used to describe any of those statements he made which were actually true. False statements were dubbed "inoperative", much to the disbelief and amusement of the Washington press corps.*

7. *"Likes their Wagner" So much more polite way of describing a member of the aristocracy who thought that the Nazis were a breath of fresh air in European politics.*

At each stage of training in the use of euphemisms in speech, we indicate the goals that we set at this stage; indicate the teaching methods; we give a system of exercises according to the level of difficulty (reproductive, productive, creative).

Reproductive exercises - finding euphemisms in the text, determining the functions of euphemisms, determining the scope of use.

Productive exercises - the ratio of incorrect words and euphemisms; the formation of euphemisms using various linguistic means; selection of synonymous euphemisms for the nominee in various fields of use.

Creative exercises - creating text for various speech situations, editing text.

Students need more time to master specific vocabulary. At these stages, students are well versed in the basics of grammar and lexicology, morphology and syntax, and are also familiar with traditions and customs.

For this process to become more productive, euphemisms must be studied in sociolinguistic aspects, since this process will facilitate students' understanding of the close relationship between language and society, and will help to take into account social changes in the language.

One aspect of sociolinguistics is the stylistic aspect. Linguist L.G. Luzina believes that the stylistic meaning is associated with the interpretation of the relevance or inappropriateness of the choice of a language unit in different conditions of communication (Luzina, 2004). The phrase should be appropriate, both in relation to the topic of speech, and to the participant in communication.

The next aspect in which it is worth considering and explaining the nature of euphemism is ethical. The ethical aspect is the moral and ethical justification for the use of one or another expression. It is worth saying that the ethical standards of speech depend on the mentality of the inhabitants of the country. To maintain the right atmosphere of communication, students should be able to choose euphemistic nominations to mitigate inappropriate expressions.

The etymological aspect is inextricably linked with the history of the language and culture of the people. Etymology draws data from such sciences as archeology, history, ethnography, geography. The etymological approach in explaining the lexical layer provides valuable material for a better understanding of the characteristics of a particular language community.

After researching the methods and techniques of working with specific vocabulary, we came to the conclusion that the following methods of working with euphemisms can be used: direct, conscious, intense and combined.

Direct teaching methods are focused on creating direct associations between words and corresponding concepts, bypassing the native language. The meaning of linguistic facts is revealed with the help of visualization, context or interpretation. Material is administered only orally.

Conscious teaching methods are focused on students comprehending linguistic facts and methods of their application in speech activity.

Intensive teaching methods rely on the psychological reserves of the student's personality that are not used in regular learning. They are characterized by: collective forms of work, the use of suggestive means of influence.

Combined teaching methods is a group of teaching methods that have features inherent in direct and conscious teaching methods. They are based on the following principles: intuitiveness combined with consciousness; oral advancing; speech orientation of training; parallel mastery of types of speech activity.

Each of these methods involves the use of certain methods of interpreting euphemisms: the interpretation of euphemisms, the use of antonymic and synonymous lexical units, the introduction of euphemisms in context, etymological information, visualization, dialogue using euphemisms.

Another technique for interpreting specific vocabulary is the selection of synonyms and antonyms for the unit under study. The advantages of this method are that it helps to establish semantic tokens nests. Although euphemisms can be interpreted in an audience where students speak a language at a threshold level, this method of semantization of euphemisms is best used at an advanced stage of training, since it requires students to have a rich vocabulary and an understanding of the stylistic coloring of words. This is a rather difficult task, which requires students to have a deep knowledge of the language, speech styles and a large vocabulary. It also all depends on the speaker's personal perception and situation.

Visualization as a method of semantization consists in demonstrating a certain reality. Most



often, visualization refers to the use of visual teaching aids: presentations, slides, layouts, diagrams. On the Internet there are many images of not only objects and faces, but also situations. However, it is not always easy to find an illustration of a particular situation or an abstract phenomenon, and the search for the necessary pictures can take a lot of time from the teacher.

Creating dialogs using certain euphemisms is very effective, as students remember the correct grammatical, syntactic and situational use of the euphemistic unit. Through dialogue, students fall into the natural environment for the manifestation of the communicative functions of the language.

Having examined the possible methods and techniques for interpreting euphemisms in the classroom, we can conclude that the most effective principle will be the combination of methods, techniques and teaching aids for these language units. Only in aggregate will they lead to the necessary results - students will be able to determine euphemisms in oral and written language, learn to use them depending on the situation, understand their hidden meaning and manipulative effect.

A lesson on the topic of euphemism, you can build on different models. Regardless of the purpose of a particular lesson, it will be advisable at the beginning to tell what a euphemism is, give a definition and explain why euphemisms should be used in speech.

## **RESEARCH RESULTS AND DISCUSSION**

One of the main tasks for teachers is to arouse interest and involvement in the subject, even if the students are not initially interested in it. It is by their choice of topic, activity, and linguistic content that they can turn the class over. It is because of their attitude towards participating in the lessons, their integrity, humor and seriousness that they can influence their students. It is through their behavior and enthusiasm that they can inspire students. For some students, writing, reading or listening can also cause fear. Whenever we tell students about some language tasks, they feel annoyed or monotonous. Therefore, teachers should pay attention to words when giving assignments to students. To some extent, teachers can give the task as a pleasure, showing it euphemistically. Some suggestions, of course, may come from students, and the teacher may make some additions. As a result, students are easily given the task of having more oral practice, and, of course, they are willing to accept this, because some of them are their own ideas. In short, for the sake of educational reform and the relationship between student affective factors and language teaching,

euphemism should occupy an important place in language teaching and learning.

Based on this, when teaching the use of euphemisms in the students' speech, the requirements for universal educational actions in the lesson were taken into account. Learning to euphemize speech helps to build the ability to conduct dialogue on the basis of equal relations and mutual respect and increase motivation in the lesson, builds the ability to analyze, classify, teaches you to work in groups and pairs, teaches you how to independently regulate the learning process. After training, the final test was carried out, allowing identifying skills in the use of euphemisms in speech. In order to identify the level of formation of these skills, students were offered two tasks.

The first task was oral. This task tested the ability to find euphemisms in the text, to explain their meaning. And to test this skill, fragments of literary works and fragments of colloquial speech were used. Students needed to find euphemisms in the text, write them out and explain what word they were replacing. The test took into account whether the student was able to find all euphemisms and correctly determine the meaning of euphemisms, based on the context.

Based on the data obtained, it can be stated that students have a higher level of formation of the ability to determine the meaning of euphemism. The high results demonstrated by students prove the advisability of introducing theoretical information about euphemisms, their functions in the text and methods of education. Consequently, conducting test work contributed to increasing the level of knowledge about communicatively correct speech in students.

The second task was written, where the composition was to consist of 150 words. It was aimed at identifying whether students use euphemisms in their speech and whether the euphemisms they bring correspond to context or situation. To this end, they were asked to write the essay "The Modern World", in which it is necessary to describe modern life, modern innovations, possible problems (social, environmental, etc.).

The results of the second task allow us to say that students actively use euphemisms in their own speech. Based on the data, it can be argued that the level of skills and knowledge in the field of speech euphemization among students has increased significantly. Thus, we can conclude that carrying out special work on teaching the use of euphemisms in speech helps to increase communicative competence, and the final results confirm the feasibility and effectiveness of the proposed training system on the use of euphemisms in speech.



## CONCLUSION

Therefore, training in the use of euphemisms in speech enhances communicative competence, enriching vocabulary. The study of euphemisms and training in the use of euphemisms in speech harmoniously correlates with the training program at various stages. The exercise system generates correct speech behavior with various participants in communication in various speech situations.

The analysis of the learning results confirms the appropriateness and effectiveness of the proposed teaching methodology on the use of euphemisms and gives grounds to assert that it helps to increase the level of students' speech development and positively affects the formation of their ethical, aesthetic, creative attitude to the word.

Thus, training in the use of euphemisms in speech helps to increase the communicative competence of students, and forms correct speech behavior. Also, the study of euphemisms and teaching the use of euphemisms in speech is harmoniously correlated with the training program at various stages, since the proposed system of exercises not only supplements knowledge, but also contributes to the formation of the student's communicative competence.

## REFERENCES

1. Akhmanova, O.S. (1966). *Dictionary of linguistic terms*. Moscow: Soviet Encyclopedia, 68.
2. Evgenieva, A.P. (1984). *Small Academic Dictionary*, Moscow: Russian, vol. 4, 746.
3. Halperin, I.R. (1981). *Stylistics of the English language: textbook. For students inst and fac. of Foreign Languages - 3rd ed. - M.: Higher school*, 79.
4. Ismatullaev, N. (1963). *Euphemisms in Modern Uzbek*. TashSPI "Ilmiy asarlar" and, vol. 42, 1-book, 59.
5. Katsev, A. M. (1977). *Euphemisms in modern English: the experience of sociolinguistic description: author. diss. ... cand. philol. sciences. L.*, 92.
6. Krysin, L.P. (2004). *Euphemisms in Modern Russian speech. Russian word, one's own and another's. Research on the Modern Russian language and sociolinguistics. -M.: Languages of Slavic cultures*, 35.
7. Luzina, L.G. (2004). *The social aspect of linguistic research/Sociolinguistics yesterday and today. - M.*
8. Omonturdiev, A. J. (2006). *Euphemism of professional speech. Academy of Sciences of the Republic of Uzbekistan. «Nauka», Tashkent.*
9. Rapaeva, Yu.V. (2019). *Teaching students to use euphemisms in speech/Modern high technology. - No. 8, 168-171.*
10. Rosenthal, D.E. (1987). *Practical stylistics of the Russian language. Textbook for universities in the specialty "Journalism". 5th edition. Moscow. Higher School*, 120.
11. Shmelev, D.N. (2002). *Selected works on the Russian language. - Moscow: Languages of the Slavs. Culture*, 76.
12. Tyurina, E.E. (1998). *Semantic status of euphemisms and their place in the system of nominative means of language*. Novgorod, 83.
13. Yartseva, V.N. (1990). *Linguistic Encyclopedic Dictionary. Glavniy redaktor. Moscow "Soviet Encyclopedia"*.
14. <https://en.islcollective.com/english-esl-worksheets/grammar/phrasal-verbs/fitting/77745>
15. [https://cdn.shopify.com/s/files/1/1092/8180/files/Euphemisms\\_Worksheet\\_Set.pdf](https://cdn.shopify.com/s/files/1/1092/8180/files/Euphemisms_Worksheet_Set.pdf)
16. [https://www.google.com/search?q=bad+script+dialogue&safe=active&sxsrf=ALeKk02k-dWaaBk2sdmUTInkTuH9Bc5OPw:1592167503586&source=lnms&tbm=isch&sa=X&ved=2ahUKEwjJiOWTloLqAhVOWqYKHZeQD4AQ\\_AUoAXoECA0QAw&biw=1536&bih=706#imgrc=IohxiILcHRrNxM](https://www.google.com/search?q=bad+script+dialogue&safe=active&sxsrf=ALeKk02k-dWaaBk2sdmUTInkTuH9Bc5OPw:1592167503586&source=lnms&tbm=isch&sa=X&ved=2ahUKEwjJiOWTloLqAhVOWqYKHZeQD4AQ_AUoAXoECA0QAw&biw=1536&bih=706#imgrc=IohxiILcHRrNxM)
17. <https://www.bbc.com/news/magazine-22545351>





## **IMPACT OF URBANIZATION ON SOCIO ECONOMIC STATUS OF AGING A CASE STUDY OF JORHAT DISTRICT OF ASSAM**

**Himanshu Gogoi**

*Assistant Teacher, Gangmouthan Govt. Girls MV School, Gangmouthan, Biswanath, Assam,*

Article DOI: <https://doi.org/10.36713/epra4778>

### **ABSTRACT**

*Aging population is evolving into a prime concern for developing countries like India as the median age of these countries are increasing with the every passing day. The problem ageing is facing by some developed countries among those japan is mentionable one. As far as concern of India at present it is not a serious current problem nor it need desperate attention. However, with the increasing median age of the population and weakening root of family values bringing a hazy future for those who are to be become aged in coming days. Perhaps it is due to coming up of new working culture which not allows the children to stay with their parents and they remain away from them for a longer period of time for the sake of job. The problem becomes a matter of serious concern when one of the spouses already died and other need social support and the children can't come to their parents even they wanted to do so. To present socio economic status of ageing impacted by urbanization with special reference to jorhat town*

**KEYWORDS** — *aging, population, urbanization, family value, economic status*

### **I.INTRODUCTION**

In general ageing or old or aged person means the persons who are above 60 year and who are mostly depended on other . If people live longer and have fewer children than before, the population is ageing. As a result, the share of elderly people in the total population rises. The so-called old-age dependency ratio displays collective ageing.

Generally the definition of old age is no general agreement on the age at which a person becomes old. The common use of a calander age to mark the threshold of old age assume equivalent with biological age, yet at the same time, it is generally accepted that these two are not necessarily synonymous., which attention was drawn to older population in many developing countries, the definition

of the old age many times followed the same path as that in more developed countries i.e. the govt. set the definition by starting a retirement.

According to Gorman,"The ageing process is of course a biological reality which has its own dynamic, largely beyond human control. However, it is also subject to the constructions by which each society makes sense of old age. In the developed world, chronological time plays a paramount role. The age of 60 or 65, roughly equivalent to retirement ages in most developed countries, is said to be the beginning of old age. In many parts of the developing world, chronological time has little or no importance in the meaning of old age. Other socially constructed meanings of age are more significant such as the roles assigned to older people; in some cases it is the loss of





roles accompanying physical decline which is significant in defining old age. Thus, in contrast to the chronological milestones which mark life stages in the developed world, old age in many developing countries is seen to begin at the point when active contribution is no longer possible." (2000)[1]

Aging population is evolving into a prime concern for developing countries like India as the median age of these countries are increasing with the every passing day. The problem ageing is facing by some developed countries among those Japan, German is mentionable one .For example, Today, the German old-age dependency ratio 65 (people older than 65 years per 100 persons aged 15 to 64) is 26.5 and will rise up to 39.3 in 2025 and 55.8 in 2050.[2] As far as concern of India at present it's a upcoming problem and so it need attention. However, with the increasing median age of the population and weakening root of family values bringing a hazy future for those who are to be become aged in coming days.

## II. PROBLEM DEFINATION

With 1.21 million population or nearly 16 per cent of the world's population, India is a vary large country. The country with 3.28 million sq. km. of geographical area has very much in the physical, social, cultural, economic and demographic attributes. With the development in the different sectors as well as in the demographic sector also change in competitive way. For example , there are vast differences in the quantity and quality of the elderly population along with their living arrangement. It is estimated that the Indian aged population is currently the second largest in the world. If the trend continues, the absolute number of the over 60 population in India will reach the level of 137 million by 2021 from 76 million in 2001.[2] Now a day the rate of the elderly population growth is 10%.

The north eastern part of India Assam, which concentrate about 31 million (2011)population over an area 78523 sq. km. The density of population is 397 and sex ratio is 954. Here the aged population increased in a venerable way only because of the increased in medical facilities ,life expectancy, birth and decreased in death rate etc. The increase in aged population good direction to the society but their life style is becomes very bed in somewhere and they spent a very dirty life. So I make a field report on the aged people of Jorhat which is becoming a serious issue for the society of Jorhat.

## III. OBJECTIVES

Every Geographical study gas some objectives. Hence we also selected some objectives to conduct our survey and analysis the data thoroughly. Our objectives of the study are :-

- i. To highlight the status of aged people in our society special reference to Jorhat
- ii. To highlight the life style of the aged people .
- iii. To make attention on weather ageing is a problem or not in our society.

## IV. METHODOLOGY

Collection of the is the prime concern in the research methodology. Like that of way first of all to fill our requirement we collect necessarily data from Secondary source like Books, Journals and Internet.

In conducting the survey we used survey schedules and purposive sampling method on our project. But due to the shortage of time we could only conduct our survey in 55 persons. We have collected primary data through schedule by door to door survey of 55 family. On doing the work we used purposive sampling method, because in purposive sampling, the selection of the units is done for purpose.

After receiving the data we processed and coded it and transferred to a master table and than represented through statistical and cartographic techniques. By analyzing the data the report is drafted containing the findings of the survey. In the introduction part we use internet, books, journal etc. and the analysis part purely primary data base.

## V. ANALYSIS

**PHYSIOGRAPHY OF JORHAT:** Jorhat district is located on the south bank of the river Brahmaputra, covering an area of 2859 sq km. in lies by the state of National Highway No 37 at a distance of 314 km to the North East Guwahati and 134 to South West Dibrugarh. It lies between 26°45' N to 94°13' E and 26°75' N to 94°22' E latitude. Jorhat share its border with Luhitsuti, North Lakhimpur on North, in the East North Naga Hills on the Sivasagar and with Golaghat district in the west. On the basis of the 2011, the district has two towns, 6 urban areas, 792 village, 6 Development Blocks and 3 subdivisions.[3]

With the acceptations of some undulating surface feature in the extream southern parts, the entire district is relatively plain with attitude varying from 150 mt 200 mts.in the southern parts and 50 to 60 mts. In the North. On the basis of local geographical features and



active geomorphologic process the district can be divided into the following three sub-divisions.

1. Northern low lying areas
2. Central fertile plains and
3. Southern highlands

District Jorhat is drained by the river Brahmaputra and its tributaries viz. Jhanji, Bhogdoi and Kakodunga which originate from Naga hills in the South. All these tributaries meet the highly river Brahmaputra which cross the district from East to West.

Jorhat district is characterized by high humid atmosphere, abundant rains and general coolness. Four reasons are general prevalent in this district with high differences in weather conditions. These are as follows :

- i. The cold seasons December to February
- ii. The seasons of severe thunderstorms March to May
- iii. The south west Monsoon June to the beginning of October
- iv. The post monsoon October to November

Temporal variations in the distribution of precipitation, temperature, humidity and evapotranspiration are the main distinguished feature of these seasons

The average annual rainfall in the district is 2000 mm. about 67% of the annual rainfall in the district is received during the monsoon from June to October. July being the month with the maximum rainfall.

**POPULATION** : Jorhat, a district of Assam in 2011, Jorhat had population of 1,091,295 of which male and female were 557,944 and 533,351 respectively. Jorhat District recorded increase of 14.69 percent to its population compared to 1991. The initial provisional

data suggest a density of 383 in 2011 compared to 350 of 2001. Total area under Jorhat district is of about 2,851 sq.km. Average literacy rate of Jorhat in 2011 were 83.42 compared to 76.34 of 2001. If things are looked out at gender wise, male and female literacy were 88.38 and 78.22 respectively. [4]

In this district the proportion of the aged population is also increased in a significant way, because the life expectancy of the people is also increased.

## VI. INFORMATION ABOUT THE AGED PERSONS

The age of 60 or 65, roughly equivalent to retirement ages in most developed countries, is said to be the beginning of old age. In many parts of the developing world, chronological time has little or no importance in the meaning of old age or aged and their related problems. So when we student of Population geography study about the aged people we are trying to study the old man and the problems related to him and his life style also. In survey time we find different type of people of different cast, different religion etc.

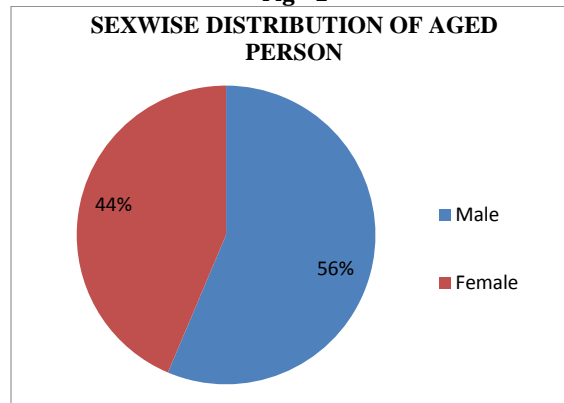
**SEX RATIO**: Numerical measurement of male and female of an given population is termed as Sex Ratio. It has been calculated differently in different countries of the world. In India it is expressed as the number of females per thousand male. The sex ratio of Jorhat is 903. Among the surveyed people we find 56% male and 44% female aged persons of different ages. The sex ratio is shown here with the following diagram.

Table- 1

PERCENTAGE OF SEXWISE AGED POPULATION		
Sex	no of aged persons	% of the aged person
Male	31	56
Female	24	44



**Fig - 1**



Source: surveyed by researcher

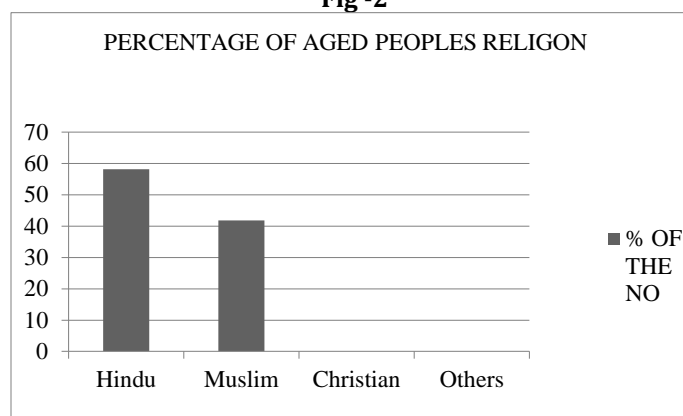
**RELIGION, CAST AND COMMUNITY :** In case of religion and cast in our survey area Jorhat maximum people belongs to Hindu religion and second religion belongs to Muslim and other religions in this area is very rare and so we have not find any other

religious person in our survey. Out of the surveyed persons about 58% Hindu and 42% peoples belongs to Muslim which is shown by the following table and diagram.

**Table - 2**

PERCENTAGE OF THE AGED PERSONS RELIGION		
RELIGION	TOTAL NO	% OF THE NO
Hindu	32	58
Muslim	23	42
Christian	0	0
Others	0	0

**Fig - 2**



Source: surveyed by research

But similarly if we consider the cast of the aged persons of the surveyed area maximum population belongs to the General cast which is about 58% and

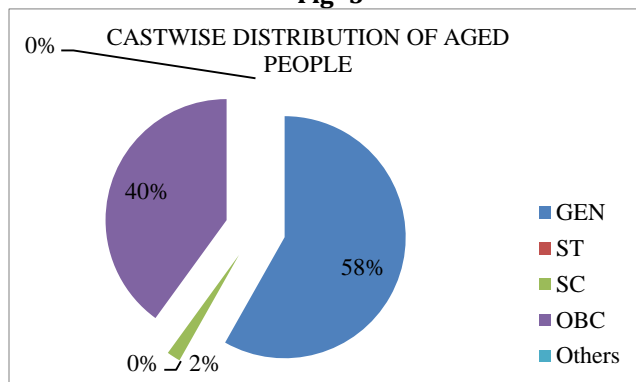
40% of the OBC and only 2% people are belongs to the ST cast out of the total 55 surveyed peoples.



**Table - 3**

PERCENTAGE OF CAST OF AGED PERSON		
Cast	Total no	% of cast of the aged person
GEN	32	58
ST	0	0
SC	1	2
OBC	22	40
Others	0	0

**Fig- 3**



Source: surveyed by researcher

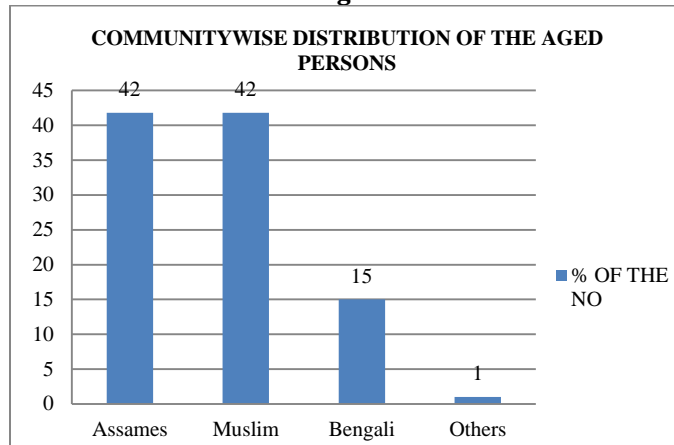
The above casts are not only belongs to the Assamese community, but they are belongs from the different communities. The following tables and diagrams represent the peoples of the different casts and communities.

**Table - 4**

COMMUNITYWISE DISTRIBUTION OF THE AGED PERSONS		
COMMUNITY	TOTAL NO	% OF THE NO
Assamese	23	42
Muslim	23	42
Bengali	8	15
Others	1	1



**Fig -4**



Source: surveyed by researcher

**AGE COMPOSITION:**

Age means the estimated or calculated interval of time between the date of birth and the date of census, expressed in completed solar year.

The population may be divided into sub-groups on the basis of age such as 0-5, 6-16, 17-24, 25-60 and >60 etc. The distribution of population in different age group is called age composition. For the academic purpose scholar, researcher and students has many scope to know age composition which is given below.....

For making elaborate study and composition.

To make inventories of human resources and planning. For examining social and economic structure. To know the changing structure

This paper considered only the aged peoples or the age group of above 60. Here in our surveyed area maximum aged people belongs to 60-65 age group whereas only 3 are in between 90 to 100 where 1 in 90-95,1 in 95-100 and 1in above 100.

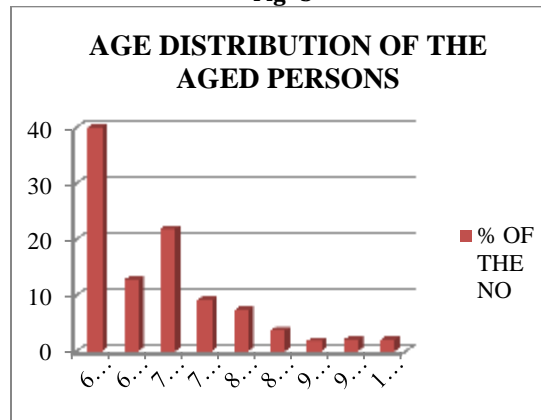
**Table- 5**

AGE DISTRIBUTION OF THE AGED PERSONS		
Age Structure	TOTAL NO	% OF THE NO
60-65	22	40
65-70	7	13
70-75	12	22
75-80	5	9
80-85	4	7
85-90	2	4
90-95	1	2
95-100	1	2
100+	1	2





Fig -5



Source : surveyed by researcher

**EDUCATION STRUCTURE:**

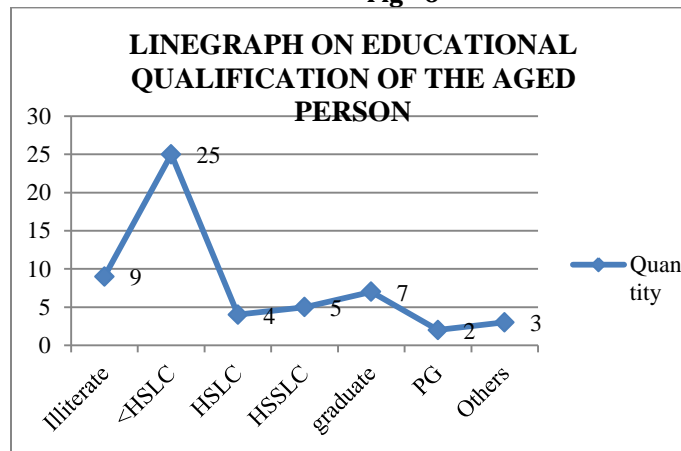
The concept of literacy varies from country to country. In India the person who can read and write to termed as literate. It is an important indicator of socio-cultural development and political consciousness. In fact it is a vehicle of socio-economic transformation as it facilitates the acquisition of specific skills and occupational competence

and accelerates the process of social change. In the surveyed area most of the aged persons are literate. But, out of them many persons are below H.S.L.C. level(25)and 4 persons are HSLC, H.S.pass(5),only 7 are graduate ,2 are PG and only 3 persons possesses other technical education .

Table - 6

TABLE FOR EDUCATIONAL QUALIFICATION	
Education Qualification	Quantity
Illiterate	9
<HSLC	25
HSLC	4
HSSLC	5
Graduate	7
PG	2
Others	3

Fig - 6



Source: surveyed by researcher



**ECONOMIC STRUCTURE :**

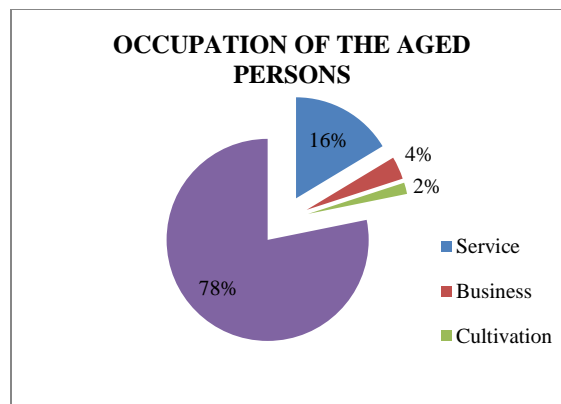
**OCCUPATION STRUCTURE :** Occupation is the primary form of activity which is curved out every person in a society. The occupational pattern of the people are classified into two categories. They are respectively primary and secondary. The aged person occupation is slightly different from others. They are not fit for every purpose. The

aged persons occupation are viz. as service, business, cultivation and pension and others. Most of the persons in the surveyed area almost 78% dependent upon on the off springs and a few of them do their service (16%) and business(4%) and other 2% is engaged in cultivation.

**Table -7**

occupation	Quantity	percentage of the no
Service	9	16
Business	2	4
Cultivation	1	2
Other/Pension	43	78

**Fig-7**



Source- surveyed by researcher

**INCOME:**Income determines the standard of living of a person in a society. Among the aged person according to their occupation they earn differently in different time. Sometimes in our society aged persons earn more than a active person but sometimes old persons totally dependent upon their off springs. When they dependent upon the others some of the off

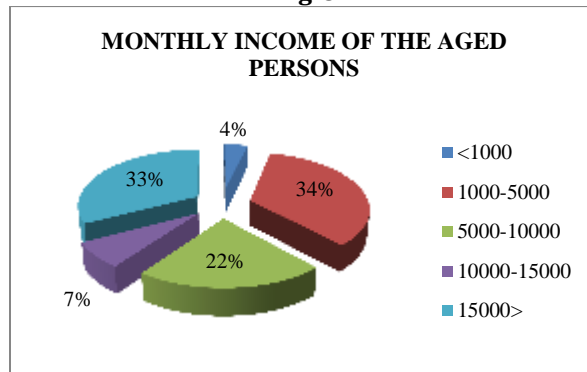
springs treated him differently. So we the student of population geography trying to study about it but we got there most of the aged persons in our surveyed area totally dependent upon self. The following table and diagram represents the monthly income of the aged persons.

**Table - 8**

MONTHLY INCOME OF THE AGED PERSONS	
RANGE	TOTAL NO
<1000	2
1000-5000	19
5000-10000	12
10000-15000	4
15000>	18



**Fig-8**



Source- surveyed by researcher

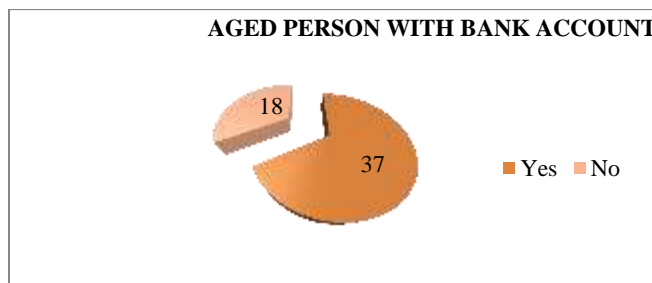
**BANK ACCOUNT** : Bank account of a man is a economic standard of man in our society. Among the aged persons is not popular in the rural areas. But in our surveyed

area most of the persons have their account such as 37 persons have their bank account in running conditions out of 55 persons. So it is very good significant to our society.

**Table 9**

Bank AC	
Responds	Total no
Yes	37
No	18

**Fig-9**



Source – surveyed by researcher

**USE OF ATM** :Whenever the bank account is most popular among the aged persons but they don't interested to use ATM as compared to the other persons in our society.

Most of the aged persons interested to withdrawal their case in mandatory process.

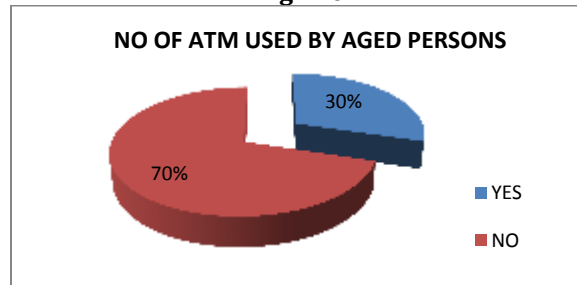
The following tables and diagrams represent the bank accounts and use of ATM by the aged persons.

**Table - 10**

Use of ATM	
RESPONDSE	TOTAL NO RESPONDS
YES	11
NO	26



**Fig - 10**



Source- surveyed by research

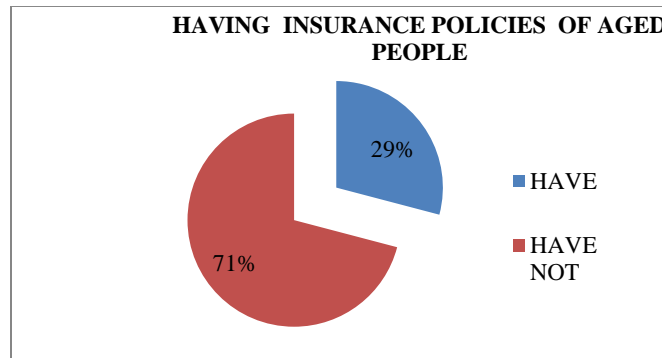
**INSURANCE POLICIES:**Insurance policies are not popular among the aged persons. So only a few persons have insurance policies in old age. Because they don't need insurance policies in this stage, they want to enjoy

themselves. So, in observed area we found only a few aged persons with insurance policy.

**Table - 11**

TABLE FOR INSURANCE POLICIES	
RESPONS	NO OF RESPONSE
HAVE	16
HAVENOT	39

**Fig -11**



Source – surveyed by researcher

**FIX DEPOSIT :** As like as the insurance policies aged persons don't need FD . correspondingly , we found only a persons with FD in our surveyed area.

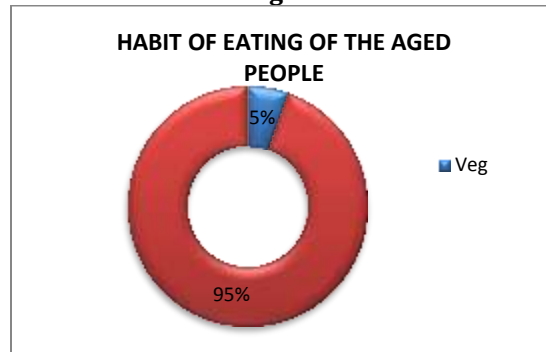
**HEALTH STATUS**

**EATING HABIT :**Eating habit means the foods which a person like to eat. Whenever he is vegetarian or non vegetarian. In our surveyed area we found 52 persons are non vegetarian and only 3 persons are vegetarian among the aged persons.

**Table -12**

Eating. Habit	
Veg	3
Non-veg	52

**Fig-12**



Source: surveyed by researcher

In other eating habit of the aged persons like smoking, liquor, beetle nut etc. we found 35 persons eating beetle nut, tobacco and others and other 9 persons smokes nad 6 persons take liquor. This represents that most of the aged persons eat beetle nut ,tobacco and others and only a few persons take liquor and smoke in their old age. The

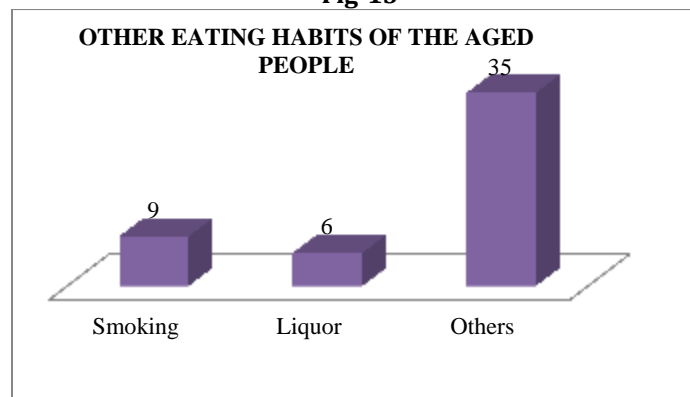
following diagram represents the different eating habit of the aged persons.

Whether the aged person is veg. or non veg., most of the aged persons food are provided by their wives or daughter in low. They are also take cared by their wives and their daughter in lows.

**Table -13**

Smoking	9
Liquor	6
Others	35

**Fig-13**



Source : surveyed by researcher

**DISEASES:**Diseases are those which becomes a person too weak. In old age this diseases attack very much. According to our survey it is clearly come out that most of the aged persons in our society are suffering from different diseases such as BP, Joint Pain, Weak Eye sight, Sugar, respiratory etc. In our surveyed area out 55 persons 33 persons suffering from weak eye sight, 30 persons suffering

from BP and 26 persons suffering from joint pain. So, from our collected data it is clear that some aged persons suffering from all types of diseases, some are two or three etc.

Whether they suffering or not but from our survey we find out that most of the aged persons get their regular medical facilities which is a very good sign for our society.

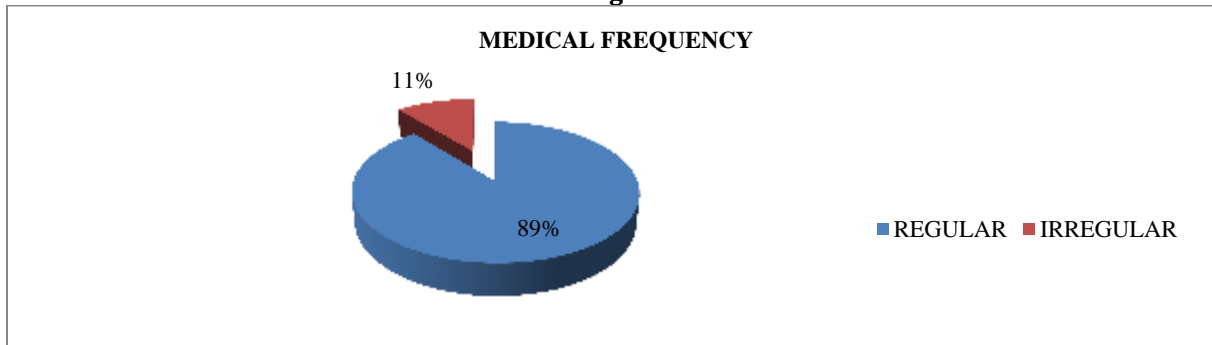




**Table- 14**

TABLE FOR MEDICAL FREQUENCY		
FREQUENCY	IN NO	% OF THE FREQUENCY
REGULAR	49	89
IRREGULAR	6	11

**Fig - 14**



Source: surveyed by researcher

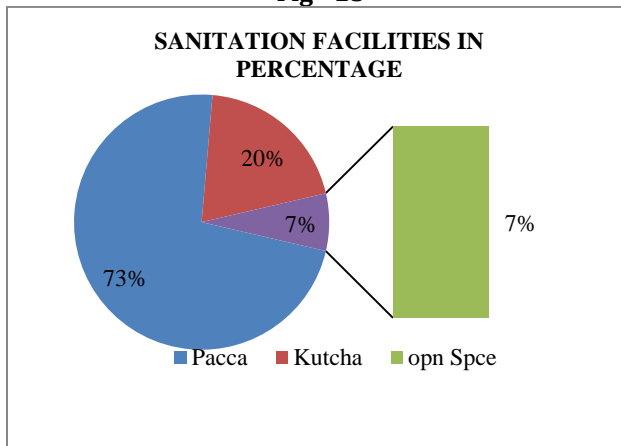
**SANITATION:**The aged persons of a society mainly depend upon others. So, they always need some good sanitation facility through which they live self dependently. The facilities which are needed by a aged person such as pacca latrine (Attached) with hot water facilities.

In the surveyed area somewhere this facilities are available but everybody don't get such facilities of sanitation, so they face various problems. The following tables & diagrams represent the sanitation facilities of the aged persons of Jorhat.

**Table -15**

TABLE FOR SANITATION		
LATRIN	USE IN NO	PERCENTAGE OF NO
Pacca	40	73
Kutchha	11	20
opn Spce	4	7

**Fig - 15**



Source: Surveyed by researcher

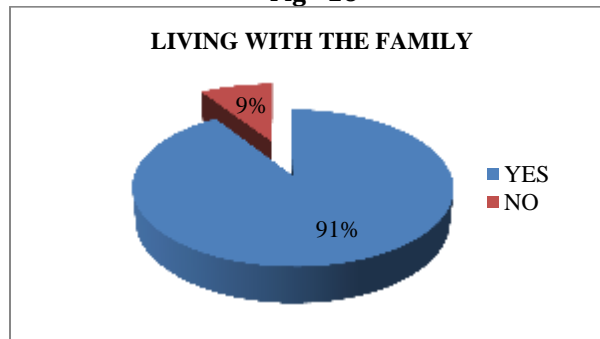


**FAMILY STRUCTURE:** To study about any person, it is very essential to know about the family. In our surveyed area we have found 50 out of 55 aged persons living with their family & only 5 persons live alone. It indicates that in our society or the society of the surveyed area accompanied the aged persons. Means the aged persons of our society do not face any problem from their families. But sometimes, it's not possible in joint families so, out of our surveyed persons about 34 persons live in nuclear family. Only 21 persons live jointly. These are shown by the following Table & diagrams

**Table- 16**

Living With Family		
RESPONSE	NO	% OF THE RESPONSE
YES	50	91
NO	5	9

**Fig - 16**



Source: surveyed by researcher

If we consider the aged person & ask them whether they are migrated or not, most of them reply no means they are permanent inhabitants. They are residing in their present address for almost 60-80 years.(20 persons) Other 35 persons, 12 are lived in their address below 20 years & 23 persons are staying there for 20-40 years.

In case of migration, migrated aged person's percentage is comparatively low in Jorhat which is 18 persons

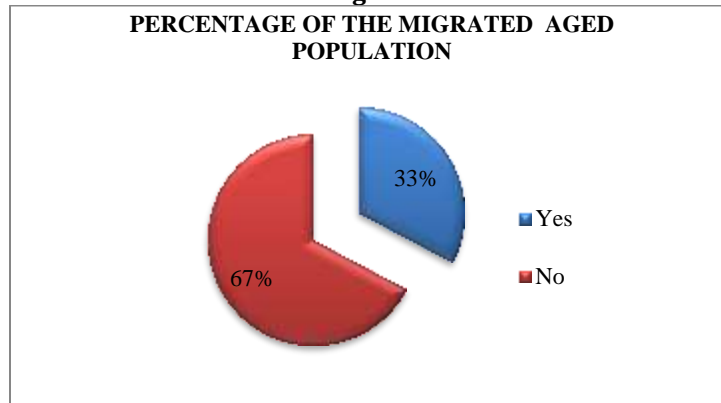
out of 55. These migrated persons came to their address for various purposes e.g.- 7 for job, 3 for business, 1 for clash & other 7 for different reasons. Most of these aged persons families are nuclear & they have one or two children also living with them.

**Table-17**

PERCENTAGE OF THE MIGRATED AGED POPULATION		
Responds	Migrated population	% of the migrated population
Yes	18	33
No	37	67



**Fig - 17**



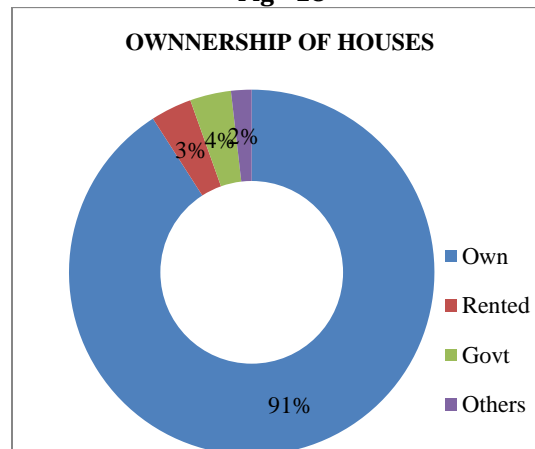
Source: Surveyed by researcher

The aged persons of our surveyed area most of them enjoy life with families in their own houses.

**Table-18**

OWNERSHIP	NOS	% OF THE NOS
Own	50	91
Rented	2	4
Govt	2	4
Others	1	2

**Fig - 18**



Source: surveyed by researcher

From the previous table, we found that out of 55 persons, 50 of them have their own house, 2 lives in rented house, 2 of them live in govt. provided house & 1 of is gypsy. Consideration of the type of houses of the aged persons we found that about 57% out of 55 persons live in pacca

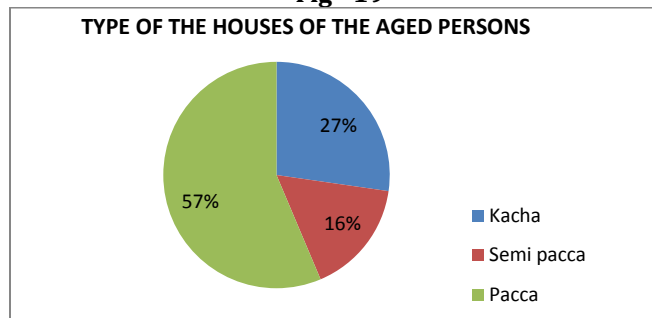
houses, 27% live in semi pacca houses and only 16% live in kutcha houses. This house types of the aged persons indicate that their socio economic condition is comparatively higher than the people of rural areas.



**Table -19**

TYPES OF THE HOUSES OF THE AGED PEOPLE		
House. Type	NO OF PERSON LIVE	% OF THE NOS
Kacha	15	27
Semi pacca	9	16
Pacca	31	57

**Fig - 19**



Source: surveyed by researcher

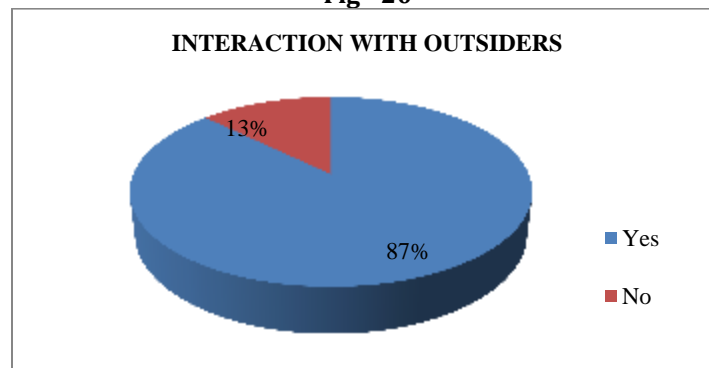
If we consider whether the aged persons are living freely with their family or not then it is absolutely right, they live with their family as they wish & interact with the outsiders. Only a few of them are suffering from family violence & live

without interacting with others. The following table & diagrams shows the above mentioned data.

**Table-20**

Table for interaction of the aged person with outsiders		
Response	In Nos	Percentage of the nos
Yes	48	87
No	7	13

**Fig - 20**



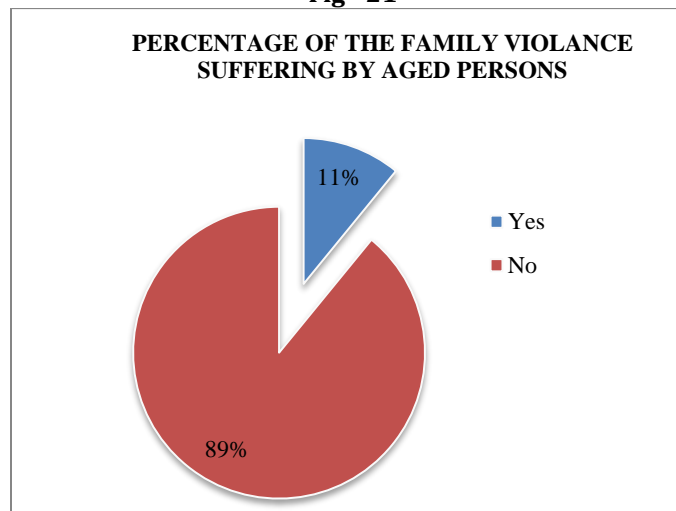
Source: surveyed by researcher



**Table-21**

Table for suffering from the family Violence		
Response	total in no	Percentage of the no
Yes	6	11
No	49	89

**Fig - 21**



Source: surveyed by researcher

**VII. FINDINGS**

1. Sex ratio of the aged persons is 56:44, where 56% male and 44% female.
2. Percentage of the religion most of the aged persons belongs to Hindu(58%), Muslim (42%), and others 0%.among this religion 58% belongs to General, 40% OBC, and only 2 % belongs to SC population.
3. Most of the aged persons belongs to 60 to 65 age group.
4. In case of educational qualification maximum aged people belongs to below HSLC(25), illiterate (9), HSLC (4), HSSLC (5), graduate (7),PG (2) and others (3).
5. Most of the aged persons have their own property and they earn their money from pensions or other sources e.g. dependent upon others which is a bed significant to our society.
6. Most of the aged persons have their own bank account but they are not interested to use ATMs.
7. There have not more insurance policies and FD among the aged persons.
8. Among the aged persons most of them are non veg and but only a few persons are interested in smoking, taking drink etc.
9. The health of the aged persons are physically weak and suffered by different diseases. But it is very

good sign that they take regular medical facilities it almost 89%.

10. Most of the aged persons get pacca sanitation facilities but they don't get as they wish.
11. Only a few persons migrated to this area and most of them permanently resided.
12. The aged persons who were migrated to our surveyed area for different purpose such as job, business, clash etc.
13. Family structure of the aged persons significantly nuclear and most of them live with their family.
14. Only a few aged persons of our society suffering from family violence and don't interact with outsiders.

**VIII. PROBLEMS**

1. Literacy problem, most of the aged persons are not highly educated they are just know to read and write.
2. Most of the aged persons depended upon the off springs.
3. Among the aged persons most persons are not get adequate sanitation facilities like pacca and attached latrine, available hot water facilities.
4. Some of the aged persons suffering from family violence.





5. Aged persons are suffering from different diseases.

## **IX. SOLUTION**

1. Improve the education system
2. Provide old age pension to the old persons
3. Improve hospital facilities
4. Provide act against the family violence suffering by aged persons.

## **X. CONCLUSION**

After analyzing the life style of the aged persons we found that in our society the aged persons are the person who is physically and socially called as the old person above the age 60. The aged persons in our society is not a problem but it is a becoming as a problem for us. Because when the percentage of the aged persons increases the dependency ratio is also increases. So the government has to take the step to control this problem.

## **XI. REFERENCE**

1. *Ministry of Health govt of UAE, www.moh.sa , retrived in Nov 2019*
2. *Mohantya Anuradha,(2002), 'Population Aging in India and the effectiveness of social assistance programme in Orissa- a human right perspective',Second World Assembly On Aging, Spain,8<sup>th</sup> to 12<sup>th</sup> April,PECUC, Orissa,p 1- 16*
3. *Geography of Jorhat, www.wikipedia.org , retrived in 2<sup>nd</sup> May, 2020*
4. *Census of india- household with aged persons, www.censusofindia.govt.in retrived on 24<sup>th</sup> March, 2020*
5. *Chandana RC,(2009), Geography Of Population, chapter 8, edition 8<sup>th</sup> , kalyani publication.*



## **A CASE STUDY ON CREATING CUSTOMER VALUE IN SUPPLY CHAIN MANAGEMENT**

**Dr. Navneet Joshi**

*Faculty, Jagan Institute of Management Studies, Near Rithala Metro Station, Rohini, Sector-5, New Delhi-110085*

**Sanjive Saxena**

*Faculty, Jagan Institute of Management Studies, Near Rithala Metro Station, Rohini, Sector-5, New Delhi-110085*

Article DOI: <https://doi.org/10.36713/epra4794>

### **ABSTRACT**

*In this post globalization era, the business units are being forced 'forced' to provide better than the best to the customers. For, today's customers are a different lot than what they used to be decades ago. They are no longer willing to be content with the 'take it or leave it attitude' of the traditional business units. They are demanding, aggressive and are determined to have the best product at a price & quality, which they are willing to pay and what they consider it to be right in their own perspective. This paradigm shift in the attitude of the customers' is forcing the organizations to be innovative and create value for the customers such as injecting technology to provide services to the customers on 24x7x365 basis across the world and assisting the customer in placing the order for a product while he is in US and to have it delivered in India at a time and place as 'dictated' by him. But, all this emphasis on creating customer value and of providing services round the clock, has the backbone of an effective, efficient and efficacious Supply Chain Management System. For, without, this core aspect, the focus on customer value goes for a toss. Thus, business units of today are keenly studying, analyzing, innovating and implementing myriad measures so as to ensure customer value satisfaction.*

*This is a conceptual case study, based on the corporate experience of the authors. The domain of the case study is the automobile sector. Initially the case study covers the basics of Supply Chain Management System and gradually it transcends to an establishment of Supply Chain Management System*

*Finally the problems at the end are focused more on the usage of analytical skills rather than the usage of the theoretical concepts of Supply Chain Management System.*

**KEY WORDS:** *Attitude, Backbone, Customer, Innovative, Value*



## INTRODUCTION

Turnaround Flip Flop Automotive Inc. (TFFA *in short*), is a multinational automobile organization having its headquarter in a beautiful city of Timbuktu, Mali, a small country in the African subcontinent. The company has its offices located in the various countries across the world such as USA, UK, Germany, France, and Australia. TAFF, of course, has its operations in India with its head office in New Delhi and the production unit in Gurgaon, Haryana. The Indian operations is handled by Mr. Zip Zap Boom (*ZZB in short*)

TAFF is into the following automobile products:

- Heavy automobiles
- Midsized automobiles
- Small sized automobiles
- Luxury automobiles
- Sports automobiles

Of late, due to increasing competition, in the automobile sector and the decreasing profit margins, Mr. ZZB decided to undertake the 'Customer Value' perception exercise of the customers on the following parameters.

- Reliability
- Quality
- Safety

- Handling
- Efficiency
- Technology

The choice of the above parameters was based on the feedback from different sources and using varied means such as indirect interactions with the clients and suggestions received at the drop boxes placed at many vantage points in the servicing centers and the like.

**Table 1**, depicts the summarized results of the feedback obtained from different sources based on the identified parameters which were of value to TAFF. The time duration of this exercise was 2 months, in which, it has been observed that the numbers of car being sold and number cars coming in for maintenance and service checkups is proportionally high compared to other time period of the year.

**Figure 1**, presents the graphic display of table 1, in the form of a pie graph. The choice of using a pie graph arose from the fact that TAFF wanted to have a bigger picture of the ratings provided by the customers. Accordingly, MR. Zip Zap Boom and his team of executives had set it as a objective to micro-manage the same and to provide better value added services to the customers.

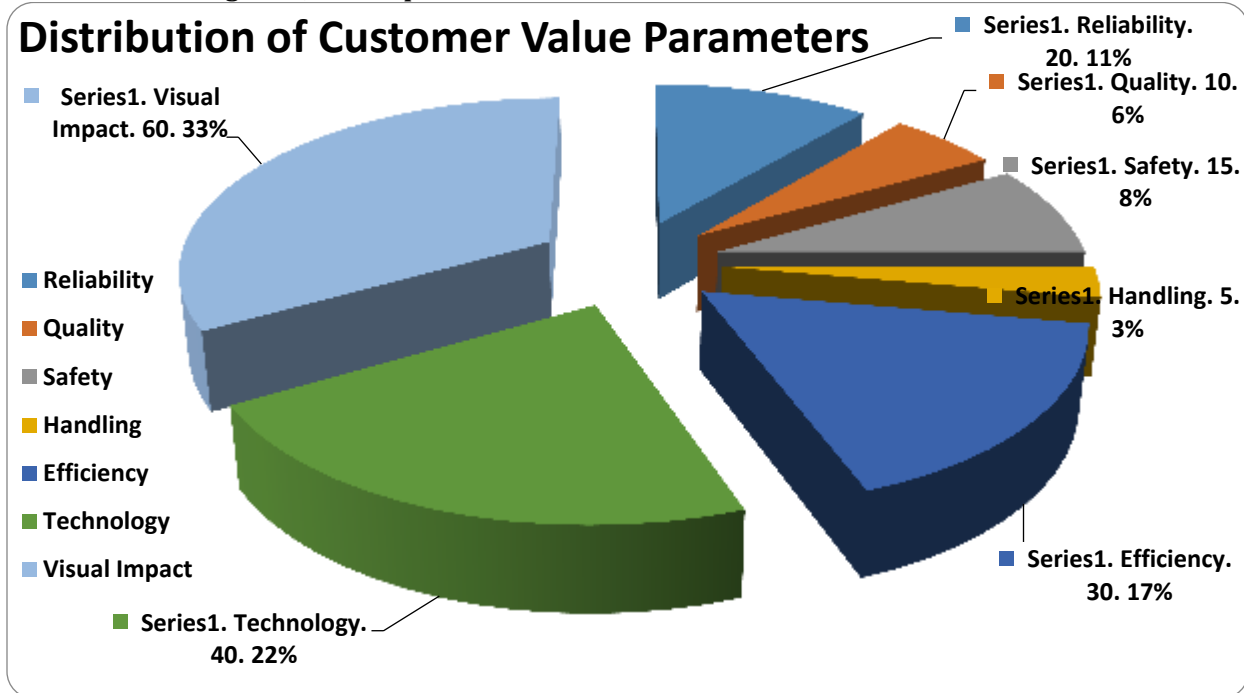
**Table 1: Customer Value Ratings**

S. No.	Customer Value Perception Parameters	Rating on the scale of 100
1.	Reliability	20
2.	Quality	10
3.	Safety	15
4.	Handling	5
5.	Efficiency	30
6.	Technology	40
7.	Visual Impact	60

**Note :** The above exercise was conducted for Mid-Sized automobiles of TAFF



Figure 1, Pie Graph for the Distribution of Customer Value Parameters



From *Table 1* & also from *Figure 1*, the team of TAFF executives agreed to address those customer value parameters which have a low rating i.e. the ratings pertaining to **Handling, QUALITY AND SAFETY COMPONENTS**.

In order, to address these parameters, Mr. ZZB, hired the services of a consultant Mr. OptiCon or OC in short. Mr. OptiCon, took a detailed study of the various processes in TAFF and proposed the following strategy to take this ahead and achieve the objective of the organization.

- Defining the micro-parameters related to Handling, Quality and Safety Issues and how can these be addressed within the ambit of Supply Chain Management components
- Defining the measurement mechanism for the identified parameters
- Defining an action plan for these parameters
- Monitoring the action plan and the results produced by them
- Optimizing the same

Mr. Zip Zap Boom, was convinced with the approach outlined by Mr. OptiCon and accordingly, the management of TAFF agreed to get this done with the initial time line of 4 months.

As a first step, in going ahead, Mr. OptiCon, prepared a detailed execution plan which covered the micro-level activities and based on this plan he started his execution.

### SCOPING OF THE PARAMETERS

- Defining the customer

This was the first step, which Mr. OptiCon undertook. He scoped the word '*customer*' in context with the linkage of Supply Chain parameters. Thus, Customers, for the context of this case study, are limited to External Customers and Internal Customers.

External Customer, invariably means the customer, who is the end user. For, example, the external customer is the one who actually buys the automobile and who in due course of time brings in his *vehicle* for servicing and repairs and he pays for these services.

Internal customers on the other hand are those customers, who, interact with one another or interact with several functional units within the organizational boundary of TAFF. For example, the Purchase department is the customer to Finance department. In the same parlance, Human Resource department is *Supplier* to all the other departments as they



supply (or provide) human resources through recruitment or job hunting etc.

- Defining the value parameter for each of the customers

The next and the crucial step involves defining “*What the customer understands the term value?*” or in other words, defining specifically the term “**Value**”. This is necessary as any lapse; any ambiguity will have disastrous effects on the other related parameters like defining the measurement for these ‘*value components*’.

- Defining the measurement mechanism

Once the values are identified or scoped, the next crucial step is defining the measurement parameters related to the value defined for each of the customers. For, without the measurement mechanism, creating customer, value, and managing the same is next to impossible.

**Table 2**, below provides examples for some of the value and measurement parameters for both the customer *viz. Internal Customers and the External Customers*.

**Table 2, Some value and measurement parameters for external and internal customers**

Customer Type	Core Parameter	Value	Measurement Criterion
External	Handling	Reception	No. of times the customer in the reception has to wait for more than 30 minutes. Eg. A customer entered the reception area at 10:00 a.m. he was attended to at 10:45 a.m.
	Quality	Timeline	No. of times the Timelines was met or missed. Eg. The car was promised to be delivered by 4:00 p.m. instead it was delivered by 4:30 p.m.
		Defect	No. of minor items which were not attended to despite noting it down on the job card Eg. The floor mat was not washed despite noting it down on the job card
		Cost	The number of times the committed estimate exceeded by 10% Eg. The estimated budget for servicing the car was Rs. 10,000/- but now it is Rs. 16,000/-
Internal Customer	Handling	Request	No. of times the request was not handled properly Eg. A request was raised by Finance to HR for recruitment of Finance executive, it was kept in abeyance beyond 2 months for no apparent reason
	Quality	Defect	No. of times the specified automobile part was found defective Eg. Piston ring of 10mm was supplied when the request was for 12 mm

Thus, we see that the above table provides vivid clues in the process of defining the value parameters as perceived by the customers and also their (possible) associated measurement components. The next step,

from this point onwards, calls for handling the supply chain management issues which directly and indirectly can affect the customer value creation mechanism.



**Table 3, provides the supply chain parameter which are affecting the customer value creation parameters**

Customer Type	Event	Supply Chain Parameter	Affected Customer Value
External	Customer reporting at the reception	Unavailability of the concerned person at the reception	Handling
	Customer is presented the bill which includes items which were carried out without his approval	The concerned manager who failed to obtain the consent of the customer for any extra work being done	Cost
Internal	The Store Manager supplies 10mm piston rings instead of 12 mm piston rings	The store manager inadvertently supplied 10 mm piston rings instead of the specified rings as detailed in the job card	Timelines

The above points provide sufficient examples of the evidence, to highlight the customer perception towards the value and its related effect on the supply chain management parameters.

### QUESTIONS AND DISCUSSIONS

For the purpose of the case study, you have been nominated to address the various issues. In particular, you are required to carry out the following

Q1. Identify the various value parameters, apart from those given above, for the identified core parameters. The identified value parameters should be supported by strong reasons as to why they constitute a value parameter?

Q2. Based on the identified value parameters, determine the various measurement parameters that would be required to address the value parameters.

Q3. Based on the above questions, identify, the various supply chain parameters which would constitute value to the customer.

Q4. Draw an action plan for implementing the measurement system and monitoring the same for the purpose of optimization.

Q5. Draw a format of the matrix report which will show the status of the parameters after 1 month when the same has been implemented

**Note:.** All the above parameters should be different from those examples presented in the case study.

### REFERENCES

#### Online Resource

- <http://www.siamindia.com/scripts/industrystatistics.aspx>
- <http://www.automobileindia.com/cars/statistics/>
- <http://www.automobileindia.com/automobile-industry/automobile-statistics.html>
- <http://www.shipvehicles.com/car-articles/the-facts-about-automobile-manufacturers.php>
- <http://www.economywatch.com/business-and-economy/automobile-industry.html>



# THE IMPACT OF EXCHANGE RATE VOLATILITY ON ECONOMIC GROWTH IN ECOWAS MEMBER COUNTRIES (2000-2018)

**Phebe Padolo Moye**

*Department of Economics, Capital university of Economics and Business, Beijing city: China*

## ABSTRACT

*This study applied the Dynamic Ordinary Least Squares (DOLS) technique to the panel data from the year 2000 to 2018 to prove empirical evidence on the long-run relationship between exchange rate and economic growth in the Economic Community of West Africa States (ECOWAS) member countries. The study generated the annual data from World Development Indicators (WDI) of the World Bank, data of the fifteen member countries on variables such as real domestic product, per capita income, the interest rate charged by banks on loans to the private sector, exchange rate and labor force. Data collected for those variables were analyzed using the econometrics technique of the panel fixed-effect model. The paper found a negative relationship between exchange rate and economic growth at 0.006 and statistically significant at both 5% and 10% percentages level of significant, the results show negative impact of real interest rate on economic growth at 0.20 and statistically significant at both 5% and 10% (percentages) level of significance in the ECOWAS member countries. The results also show the existence of positive relationships among labor and per capita income on economic growth (GDP) to be 0.24 and 0.41 significant at both 5% and 10% (percentages) level respectively in ECOWAS member countries. The granger causality test results have shown the relationship to be unidirectional causality from economic growth to the exchange rate. This investigation concluded that the exchange rate is a significant factor for policymakers to consider in process of monetary policy formulation in the stimulation of economic growth in ECOWAS member countries.*

**KEYWORDS:** *Exchange rate; ECOWAS; Economic Growth; DOLS; Granger Causality.*

## CHAPTER ONE

### 1.1 INTRODUCTION

Since the end of World War II, developing and developed countries in the world started experiencing some modern economic transformation and opening up their economies for open trade, wherein taking in to consideration the market forces interactions, with some countries allowing the free movement of the invisible hands on the market, thus ushering in comparative advantage form of trade among countries in the world.

With the introduction of this form of modern trade and the modernization of the production sector most developing countries have very low comparative advantages to that of developed nations that have the

balanced growth path and still at continue on the balanced growth path, they are highly at advantage them poorer countries that are considered partners in trade.

In order words, poorer countries highly depend on richer countries for the major transaction of key commodities to the economies, which the West African countries are of no exception. Jhingan M.L. ( 2009) defined the exchange rate as the rate at which one currency of a particular country is exchanged for another country's currency, he went on to elaborates that it is the value of one currency in terms of another currency. The exchange rate is among those macroeconomics indicators that have a significant



effect on the scope of other macroeconomic aggregates, and most importantly it has a great impact on the Gross Domestic Product (GDP), money supply, interest rate, and inflation rate.

In pursuant of the switch from the Bretton Woods Agreement that considered the exchange rates to a fixed value of the U.S. dollars to that of the price of gold for active nations of interest, to the floating rate of U.S. dollars in the 1973 by President Richard Nixon announcing the removal of the United States from the gold standard, when the postwar excess balance of payments turned into a deficit account, thereby bring into force the move of capital relaxation and causing exponential growth in the exchange rate cross countries financial transactions during the past four and the half decades, a significant excitability and doubt in exchange rate has heavily hidden the foreign exchange market causing it to become a major factor in economic growth.

According Cornell (1982) demonstrated a test establishing a framework between money supply declaration by using a joint hypothesis, and the impact on the real interest rate and that variation in the real interest rate has consequences on the exchange rate in the short run. He, therefore, reckon that the monetary model of the balance of payments means that changes in the dollar value of a country's currency to foreign exchange will eventually have a positive correlated with announced of money supply innovations.

However, the impact of exchange rate on economic growth and the determination of economic performance is key among scholars, academicians and policymaker which most of them pointing at exchange rate excitability as relevant attribute to the financial crisis in the world economic performance and most of all the unpredictable increasing inflation in West African countries, the topic has been a point of controversy considering its contribution on the determination of macroeconomic performance, exchange rate has experienced huge both empirical and theoretical studies. From the standpoint of microeconomic, Shabl (2007) figure out that exchange rate excitability decreases the macroeconomic performance which leads to a huge reduction in savings or Gross Domestic Product as raises the cost of international trade as well as the increasing of capital flows which hampering investment activities and causing macroeconomic instability for the Economic Community Of West African States (ECOWAS)

According to Baltagi (1995) panel data give the historical records for the fact that the countries are heterogeneous in terms of their economic policies drives the macroeconomic performance and standards

within a specific dynamic duration, a condition that can be either found in neither cross-section studies nor time series data. Moreover, in panel data analysis we include all the countries variable of interest" data without having to resort to aggregation or averaging, which of unconditionally eliminates all biases associated with the latter.

Secondly, the study will employed dynamic panel data analysis to account to the perseverance of the effect of exchange rate movements on the macroeconomic variables mentioned. In this vein, dynamic panel data is employed instead of plain OLS as employed in previous empirical studies related to exchange rate volatility on economic growth in ECOWAS countries and furthermore this empirical study also employed new independent variables such as per capita income, interest rate, labor and exchange rate which some of variables have been used to investigate exchange rate excitability on economic growth in ECOWAS ( Jibrin and Gylych, 2017). Thus, the study is intended to fill the gap by using pool panel data of the fifteen West African countries that make up the Economic Community of West African States (ECOWAS), the period for this empirical analysis covered from the year 2000 until 2018.

The results have vital policy inferences as it will help decision-makers to formulate a robust monetary policy in the ECOWAS member countries namely, Niger, Mali, Mauritania, Burkina Faso, Senegal, and The Gambia others include, Guinea-Bissau, Guinea, Sierra Leone, Liberia, Ivory Coast, Ghana, Togo, Benin, and Nigeria respectively. Meanwhile, the result of this empirical study reveals satisfactory evidence that there exists a negative relationship between exchange rate excitability and economic growth for the ECOWAS countries. Besides, the empirical results show a unidirectional causality relationship between real exchange rate and economic growth in ECOWAS countries.

The rest of this paper is organized as follows, Section two consist of literature review which deliberated on the theoretical foundation and empirical evidence about exchange rate and economic growth; section three presents the econometrics and methodology used; section four presents the empirical findings of the study and discussion; and section five presents the summary and conclusion.

## 2. REVIEW OF LITERATURE

There exist a plethora of theories to explain the impact of exchange rate volatilities on macroeconomic performance. One variant of literature stresses the impact of exchange rate volatility on trade whilst others



stress on how indifferent exchange rate systems, real and monetary shocks in the international macroeconomics influence the domestic economy; how exchange rate volatilities influence foreign direct investment and economic growth. The theoretical literature is more fully explained below.

According to Taylor, he view exchange rate as an important factor of monetary policy which serves as transmission mechanism in policy-evaluation models, exchange rate serves as arbitrage equation relating the interest rate in one country to the interest rates in other countries through the expected rate of appreciation of the exchange rate, the exchange rate also affects the terms of trade and thus the flow of exports and imports, although, Taylor was pessimistic on difficulties to model exchange rate effect, but he is equally optimistic about how changes in the exchange rate affect the price of foreign goods sold in another country and are then passed through to domestic prices (Taylor, 2001), although, this has been substantiated in the work of (Katz 1973).

The theoretical models on the impact of exchange rate instability on trade is varied and explained by partial equilibrium and general equilibrium models. The partial equilibrium approach has been explained in the literature by Clark (1973), Hooper and Kohlhagen (1978), Makin (1978), Cushman (1983, 1986) among others. The partial equilibrium approach assumes that there exist no hedging possibilities, firms are risk-averse, a higher proportion of incomes and expenses are in foreign currency such that exchange rate excitability negatively influences the level of trade.

This is because firms do not change their output levels following a change in the exchange rate as production plans are made well in advance in anticipation of changes in exchange rates. Cushman (1983, 1986), claims that the impact of exchange rate excitability on trade is alleviated to the extent that if the cost of export is priced in a devalued currency, the depreciation cost that might ascend from the depreciated exchange rate might be offset moderately by incomplete pass through. The partial equilibrium approach also assumes that the only variable that changes is some measure of exchange rate excitability and all other factors persist unaffected. Also, according to Makin (1978) evaluated Clark's view and recommended that hedging potentials to exist such as the impact of trade on exchange rate changes can be prevaricated.

In order, to get a more tangible image of the impact of exchange rate excitability, the universal equilibrium framework considers all major

macroeconomic variables. In this manner, Bacchetta and Van Wincoop (2000) established a simple two countries model wherein uncertainty originates from monetary, fiscal and technology shocks and the level of trade as well as welfare are compared below diverse exchange rate regimes. This theory is based on the evidence that an increase in the money supply in the foreign country is followed by a devaluation of that foreign currency, which causes a decrease in the demand for imports. The author concludes no the relationship between trade level and exchange rate regime.

Though, increased aggregate demand generated by the additional increase in the money supply may stop a part or almost all the exchange rate effects on economic growth. As such, a condition that causes changes in the exchange rate causes the same to changes in other macroeconomic variables that influence the fluctuation of the exchange rate. Tenreiro (2007) and Arize et al (2008) find a negative relationship between exchange rate excitability and exports in new emerging countries. Hondroyannis et al. (2005) observe the relation between exchange rate excitability and export for 12 industrial economies using GMM and random coefficient (RC) regressions and find an insignificant and nonnegative link between exchange rate and trade. Conversely,

Many different empirical works also tested the relationship between investment and exchange rate, Nucci and Pozzolo (2001), Harchaoui, Tarkhani and Yuen (2005) Campa and Goldberg (1999) in the process of formulating these distinct dynamic optimization adjustment-cost model there were some minor variations in the formulation, give the theoretical link between exchange rate and investment. On the other hand, the standard adjustment-cost model assumes that firms must operate in an imperfect market can do the necessary adjustments in addressing the cost conditions through setting up prices as a mark-up over the total costs of production. As a result, there are three sets of dynamics were recognized; the first was to prove that exchange rate instability negatively affected investment through domestic sales and export sales. With continuing money supply of a country's currency leads to the depreciation in that currency causing the goods and services that are produced domestically less value compared to foreign ones, limiting the production power of domestic product and also causing much domestic currency to go after little foreign currency value of goods and services. When the domestic product becomes cheaper it serve as a pooled factor for exportation eventually increase in order to keep those firms functional in the production sector, while firms of



foreign investment based on labor and capital, marginal revenue of the primary input would gradually increase making these firms to then responded by making additional investment in capital Campa and Goldberg (1999).

Instability in the real exchange rate creates unstable conditions for investors to make sound investment decisions because investors heavily rely on their investment decisions based on information on monetary information acquired from the market about the real exchange rates if investments are unstable and exert negative pressure on economic performance (Campa & Goldberg, 1995).

The second aspect of this result is provided by Harchaoui, Tarkhani and Yuen (2005), that depreciation in the country's currency would lead to an increase in the cost of investment with an opposite relationship which in return lowers the investment power and causes the cost of imported commodity to go through adjustment costs by the effect of exchange rate changes.

Thirdly, Nucci and Pozzolo (2001) Depreciation in currency would cause an increase in the total production costs and result in the reduction of marginal return on investment. This certainly proved that exchange rate volatility significantly affected investment through the cost of imported commodities. Therefore, the effect on the marginal profitability would be proportional to the share of import of the total inputs required for production. Production costs and therefore reduce marginal profitability. The effect on the marginal profitability would be proportional to the share of imported inputs required for production.

In summary, the three results of exchange rate variation make it difficult to rounder an empirical judgment on the direction in which the changes in the exchange rate would affect the level of investment and eventually economic growth.

Sub-Saharan Africa is the region of the world in which most almost all countries within that are faced with having a slow or experiencing negative economic growth causing these countries to lead to low accumulation of real income from one period to another (Jelilov and Yakubu, 2015). (Adeolu and Godwin, 2013) in their theoretical work, they showed, that there is an extraordinary difference in the performance of their real exchange rates. (Martin, Peter, and Arslan, 2012) their theoretical framework showed that some characteristic with the developing economy is undervaluation, gave reference on the relationship between real exchange rates (RERs) and economic growth, an increase in undervaluation leads to

economic growth just as extraordinarily as a decrease in overvaluation, such relationship holds only for developing nations, in further findings in recognizing the relationship between undervaluation and economic growth (Eichengreen, 2007) and (Rodrik, 2008) presented their empirical framework which they concluded that there is a positive relationship between undervaluation and economic growth only for developing economies. But in the case where the sample size is limited to developed countries that relationship malts down, and it gets more solid the poorer the country.

Many contributing factors cause the slow in the economic growth of Sub-Saharan African countries reaching from corruption, low human capital or labor, high-interest rate, opposing terms of trade, and limit access to foreign loans.

(Daneshwar & Thomas, 1992), showed the external factors that have also contributed to slow in the economic growth rate of developing countries and other factor that are not frequently named are the internal factor which is the political will by the leaders, rule of law, legitimacy and democracy of this region to tackle the major problem frontal and with unbalanced political administrations gave birth to the slow economic growth rate experienced in ECOWAS countries. This implies that the region needs a robust mechanism that can help promote speedy economic growth to upgrade some of these problems Sissoko and Dibooglu (2006).

### 2.1 Situational Analysis in ECOWAS

In order to tackle the issue of exchange and promote economic growth the Sub-Saharan African (SSA) countries have formulated different strategies, key among these are, the unification of Africa in to a one bloc called The Organization of African Unity (OAU) or African Union (AU) and dividing Africa in four regions with each region establishing strong and powerful organization. In the year 1960s, various African countries started breaking away from their colony masters establishing their own currency boards such as the former British colonies and the former French colonies they decided to form a monetary union called "CFA franc zone".

The creation of institutions eventually gives rise to the proliferation of various types of currencies, which are seen as impairment to trade, integration and economic transformation in SSA. In act of limiting these deficiencies and promote economic transformation the West African States by the establishment of ECOWAS on the 28<sup>th</sup> day of May 1975 Lagos Nigeria by Heads Of States of West African countries, in order reduced these impediments





and promote regional integration, rule of law, political regulations and economic development by these countries within the western part of the Sub-Saharan Africa.

Through this fabric effort serious institutions have been established within ECOWAS in addressing these major contributing factors of economic growth, ECOWAS consist of two institutional units that are a focus on polices implementations, are ECOWAS Monetary institutions and the ECOWAS Secretariat. The ECOWAS monetary board established the ECOWAS Bank for Investment and Development including others monetary institutions associated with ECOWAS is West African Economic and Monetary Union (WAEMU), West African Monetary Zone (WAMZ), and the West African Monetary Agency (WAMA) (Central Bank of Nigeria, 2016).

The WAEMU, which is also known as UEMOA in French, is an organization that was established by eight West African states. It was established to promote economic integration among its member states that share the CFA franc as a common currency. Recording its accomplishments of WAEMU, It has adopted a customs union and common external tariff and has combined indirect taxation regulations, in addition to initiating regional structural and sectoral policies and has successfully executed macro-economic convergence criteria and an effective investigation mechanism. ECOWAS and UEMOA have formulated a mutual plan of action on trade liberalization and macroeconomic policy convergence. The organizations have also agreed on common rules of derivation to smooth the movement of trade, and ECOWAS has also accepted to approve WAEMU customs declaration forms and compensation instruments.

Another monetary institution was established called the West African Monetary Institute (WAMI) Issiaka and Blaise, (2013), which has been charged with the responsibility of the creation of a single currency to be known as the ECO and the establishment of circumstances of the launch of ECO. This institute is a burden with the duty to carry out the multilateral establish the status of the Central Bank of West Africa, investigation of macroeconomic performance, and formulate the structure and policy frameworks of the WAMZ monetary union. The lack of macroeconomic convergence has delayed the schedule. The launch date of the ECO has been postponed from 2003 to 2005 and 2009. Taking into cognizance the effects of the global economic crisis on macroeconomic convergence of the members' economies, WAMZ countries have finally decided to reschedule the launching of the ECO after the creation of the Central

Bank in Ghana after which the merger of the Eco and West African CFA franc was planned to be achieved by 2020.

In 1996 ECOWAS created the West Africa Monetary Agency (WAMA) after it changed from the West African Clearing House (WACH), its main goal was to promote multilateral payment facilitation within West Africa. It also served as coordinating and implementing the ECOWAS Monetary Cooperation Program (EMCP) the major characteristics of the ECOWAS monetary union have been defined in this program, that is: management and pooling of all reserves, common monetary policy, and common convertible currency, an agreement on how to create a single was guarantee, and among other reasons in order to this plan achieve they hurry encouraged creation of the ECOWAS single currency.

In December the year 2000, the leadership of ECOWAS reaches a new decision to create more force by developing another strategy that was launched called the "Acceleration".

This new strategy was divided into two stages: the formation in 2003 of a second monetary union WAMZ whose mutual currency will be called "ECO", and the merging of the latter with the WAEMU in 2005. In this perspective, first-order and second-order junction criteria have been defined.

With reference to second-order criteria, they focus on the monetary and exchange rate policies management (stable nominal exchange rate and positive interest rate), and also on the structure of public accounts (no domestic arrears, salary mass lower than 35% of tax revenue, tax revenue greater than 20% of GDP, and public investment greater than 20% of domestic receipts). (Issiaka & Blaise, 2013) The launch of the new currency is being developed by the West African Monetary Institute based in Accra, Ghana. However, several of the WAMZ's countries are facing huge challenges of depreciation in currencies and budget deficits, including a high inflation rate.

### 3. ECONOMETRICS MODEL AND METHODOLOGY

#### 3.1 Hypothetical Framework

Robert Solow (1980), he certainly developed a model in order to analyze economic growth by using three basic components for the Gross Domestic Product (GDP) inclusively, Capital (K), Labor (L) and Knowledge or Technological Progress (A).

$$Y = AK^{\alpha}L^{(1-\alpha)} \dots\dots\dots 1$$



A counter-argument was augmented by Romer (1986) and Lucas (1988), that the Solow model should be extended by including the additional variable of interest which is human capital, in their view the inclusion of human capital can better lead to a more fascinated technology and stimulate economic growth. Giving the model in this form:

$$Y = K^\alpha (AH)^{1-\alpha} \dots\dots\dots 2$$

Meanwhile, the inclusion of additional variable in to the endogenous growth model have been allowed, additional review concerning economic growth incorporate various variables in their model such as, exchange rate, Life expectancy, government revenue, inflation, interest rate, government expenditure, labour, consumption expenditure, government budget, Foreign Aid, corruption, population growth rate and financial monetary system Anaman; 2004 and Kogid at el; (2010). Therefore the specification on the model created from Cobb Douglas production function as follows:

$$Y = A_{it} K_{it}^\alpha LAB_{it}^\beta \dots\dots\dots 3$$

Where Y represents total output in the economy, A denotes the level of technological progress K represents the amount of capital shock,  $\alpha$  symbolize output elasticity of capital; and LAB exemplifies the Labour force, whereas  $\beta$  characterizes the output elasticity of the labor force.

We can rewrite equation (1) as:

$$Y_{it} = f(K, LAB, A)$$

The second equation above K is referred to as the total physical capital investment into productivities; it is observed that the capital stock of the economy is not negative, that the factor K affects the output through capital investment.

Therefore, total output (GDP) can be affected by total physical capital and solely depends on technological progress to raise the output growth with an economy. This means that the impact of the exchange rate towards economic growth can be possibly operated through capital accumulation via the level of technological progress of the host nation (Polodoo, Padachi, and Seetanah, 2011) whereas the transfer of capital is done through the exchange rate. Meanwhile, the paramount objective of this empirical study is to analyze the impact of exchange rate excitability on economic growth; it is therefore assumed that the exchange rate (REX) is the function of total physical capital. Wherein equation (3) can be converted as follow:

$$K_{it} = f(A, LK, LRT, EX, LAB)$$

From equation (3) specify the model for the estimation of the impact of exchange rate excitability toward economic growth through the production function, via the GDP as they depend with four independent variables as LK, LRT, EX and LAB. Therefore, the model can be formulated as follow:

$$LGDP_{it} = \alpha_{it} + \beta_1 LK_{it} + \beta_2 LINTR_{it} + \beta_3 EX_{it} + \beta_4 L_{it} + \mu_{it} \dots\dots\dots 5$$

Note;  
 $LGDP_{it}$  = the log of GDP per capita in dollars of the panel data of all 15 ECOWAS member countries,  
 $LK_{it}$  = log of per capita income,  
 $LINTR_{it}$  = log of interest rate charged by banks on loans to the private sector in ECOWAS panel data.  
 $EX_{it}$  = the exchange rate of each country's currency to the United States Dollars  
L = is the percentage of active labour participation in the each country's economy.  
 $\mu_{it}$  = is the unexplained factor or the error term of the model.  
it = shows the panel natural of the data used in this research.

**3.2 Empirical Methodology**

To estimate the dynamic ordinary least square, using the panel Co-integration technique is used, by using the following steps:

**3.2.1 Panel Unit Root**

To check the stationarity of the panel data time series, this study used the unit root test to adjust the difference in the variance and the mean within both the explanted/dependent and explanatory/independent variables. A unit problem may exist in data that randomly collected over a large period. In identifying a unit root problem in panel data there are many tests, namely, I'm, Pesaran and Shin (IPS) (2003); Levin, Lin, and Chu (LLC) (2002) and Maddala and Wu (MW) (1999) and Hadri's (2000). Therefore, the unit root tests can be formulated as follows:

$$\Delta Y_{it} = \alpha Y_{it-j} + \sum_{j=i}^{pi} \beta \Delta Y_{it-j} + \varepsilon_{it} \quad i = 1, \dots N: t = 1, \dots T$$



The null hypothesis states that there is an existence of unit root in each of the panel series in the panel, while the alternative hypothesis assumes that some panel does not have a unit root, making it not all individuals to be non-stationary. The LLC tests the hypothesis of  $\alpha=0$ , the null hypothesis states that each time series in the panel is non-stationary, whilst IPS tests  $\alpha=0$  in each country time-series data for stationary. Furthermore, the IPS test form a simple average of the individual's panel to test  $\alpha=0$  by using T-bar statistics. The t-value can be computed as follows:

$$Z_{tbar} = 1/N \sum_{i=1}^n Z_{it}$$

**Panel Co-integration**

After testing to know the stationarity of the panel data and ratifying that each series is integrated of the same order, the second step is used to test to know if these series can be joint together into a single series, making it non-stationary, which can be call co-integration test. Whereas, the Co-integrated series change going in one direction in the long-run relationship and they are in equilibrium relationship-integration, Granger developed the causality tests in the

year 1981 and there was more improvement in 1987 by Engle and Granger. To find an intuitive solution to this problem, scholars introduce panel co-integration which served as an analytical tool for both cross-sectional and time-series data to analyze the relationship among the variables which are non-stationary order I (1). For this study, the extended Engle-Granger co-integration test (1987) employed the Padroni panel co-integration test (1999) to examine the influence of the exchange rate on economic growth in the fifteen countries in the Western part of Africa called ECOWAS in the context of panel data.

Seven co-integration tests are presented by Padroni which are categorized into two dimensions they are: the within dimension based statistics, which is referred to as co-integration statistics comprising of four test panels: panel t-statistics (parametric), panel t-statistics (non -parametric) and v-statistics, panel statistics. And the other category is between- dimension based statistics, which are referred to as group mean panel co-integration statistics. These category tests are divided into three groups namely: group p- statistics, group t-statistics (non -parametric) and group t-statistics (parametric).

1. Panel v statistic:

$$Z_V = \left( \sum_{i=1}^N \sum_{t=1}^T \hat{L}_{11i}^{-2} \hat{e}_{i,t-1}^{-2} \right)^{-1}$$

2. The panel t statistic:

$$Z_V \equiv \left( \sum_{i=1}^N \sum_{t=1}^T \hat{L}_{11i}^{-2} \hat{e}_{i,t-1}^{-2} \right) \sum_{i=1}^N \sum_{t=1}^T \hat{L}_{11i}^{-2} (\hat{e}_{i,t-1}^{-2} \Delta e_{i,t} - \hat{\lambda}_i)$$

3. The panel t statistic (Non-parametric) :

$$Z_t = (\hat{\sigma}_{N,T}^2 \sum_{i=1}^N \sum_{t=1}^T \hat{L}_{11i}^{-2} \hat{e}_{i,t-1}^{-2})^{-1/2} \sum_{i=1}^N \sum_{t=1}^T \hat{L}_{11i}^{-2} \hat{e}_{i,t-1}^{-2} (\hat{e}_{i,t-1}^{-2} \Delta e_{i,t} - \hat{\lambda}_i)$$

4. The panel t statistic (parametric):

$$Z_t^* \equiv (\hat{S}_{N,T}^{*2} \sum_{i=1}^N \sum_{t=1}^T \hat{L}_{11i}^{-2} \hat{e}_{i,t-1}^{-*2})^{-1/2} \sum_{i=1}^N \sum_{t=1}^T \hat{L}_{11i}^{-2} \hat{e}_{i,t-1}^{-2} (\hat{e}_{i,t-1\Delta}^* \hat{e}_{i,t}^*)$$

5. The group t statistic (parametric):

$$\tilde{Z}_p \equiv TN^{-\frac{1}{2}} \sum_{i=1}^N \left( \sum_{t=1}^T \hat{e}_{i,t-1} \right) \sum_{t=1}^T (\hat{e}_{i,t-1} \Delta \hat{e}_{i,t} - \hat{\lambda}_i)$$



6. The group t statistic (non-parametric):

$$\tilde{Z}_t \equiv N^{-\frac{1}{2}} \sum_{i=1}^N (\hat{\sigma}_i^2 \sum_{t=1}^T \hat{e}_{i,t-1}) \sum_{t=1}^T (\hat{e}_{i,t-1} \Delta \hat{e}_{i,t} - \hat{\lambda}_i)$$

7. The group t statistic (parametric):

$$\tilde{Z}_t^* \equiv TN^{-\frac{1}{2}} \sum_{i=1}^N (\sum_{t=1}^T \hat{S}_i^{*2} \hat{e}_{i,t-1}) \sum_{t=1}^T (\hat{e}_{i,t-1} \Delta \hat{e}_{i,t})$$

$$\hat{L}_{11} = \frac{1}{T} \sum_{t=1}^T \hat{\eta}^2 + \frac{2}{T} \sum_{s=1}^K \left[ 1 - \frac{S}{K_1 + 1} \right] \sum \hat{\eta}_{it} \hat{\eta}_{it-s} \hat{\sigma}^2_i = S_i + 2\hat{\lambda} = \frac{1}{T} \sum_{t=1}^T \hat{\eta}_{it} \hat{\eta}_{it} \hat{\sigma}^2_{N,T} = \frac{1}{N} \sum_{t=1}^T \hat{L}^{-2} \hat{\sigma}^2_i$$

$$\hat{S}_i^{*2} = \frac{1}{t} \sum_{t=1}^T \hat{\eta}^{-2} \quad \hat{S}_{N,T}^{*2} = \frac{1}{N} \sum_{t=1}^T \hat{S}_i^{*2},$$

And the residuals  $\hat{\eta}_{it}$ ,  $\hat{\eta}_{it}$  and  $\hat{\eta}_{1t}$  are obtained from the following regression:

$$\hat{e}_{it} = \hat{\gamma}_i \hat{e}_{it-1} + \hat{\eta}_{it} \hat{e}_{i,t} \hat{\gamma}_i \hat{e}_{it-1} + \sum_{k=1}^{Id} \hat{\gamma}_{i,k} \Delta \hat{e}_{is-k} + \Delta \hat{\gamma}_{it} = \sum_{M=1} \hat{b}_{mi} \Delta \chi_{mi,t} + \hat{\eta}_{i,t}$$

The pradroni panel co-integration tests were developed by Philips and Moon and Padroni in 1995, 1999 and 2000 respectively, also, the Dynamic OLS (DOLS) which was developed by Kao and Chiang in 2000. Given the significance of testing the long-run relationship among panel Co-integration results, can be tested using the panel co-integration estimation as follow: Ordinary Least Square (OLS), fully modified OLS (FMOLS) estimators. Because of the biasness of the OLS estimator realized by Kao (1999) found an alternative in analyzing non-stationary data called the full modifier meant to correct the serial correlation and endogeneity of the OLS estimator. Whereas, the null hypothesis state that, there is no co-integration among residuals which are non-stationary. On the other hand, the alternative hypothesis states that there is the existence of stationarity among residuals, there is a co-integration. Finally, fully modified OLS was then developed by Philips and Hansen (1990), and extended to the context of heterogeneous panels by Pedroni (1997).

(1997). This method is the most preferred form of testing as compared to Static OLS and Johansen and Juseliu's approach due to the following reasons. Firstly, this method is considered to be more robust and appropriate for a small sample size which infers more efficient and unbiased estimates (Singh, 2010; Majeed, 2007; Masih and Masih, 1996). Furthermore, DOLS was established to be more powerful than FMOLS or other estimation methods. Therefore, it is beneficial in estimating both homogenous and heterogeneous data. This implies that it uses both within and between dimension approaches. The between dimensions estimation provides results for a specific country that is interpreted as the mean value of the co-integration vector which requires the use of the pool mean group to estimate the average. The property of the pool means the group is that to treats variables of larger observations cross-section and period. And within dimension portion gives results which are the same in each country. Therefore, the study used the within dimension estimation since the data does not require averaging.

### 3.2.4 Dynamic Ordinary Least Square (DOLS)

Once, the effect of the long-run relationship among the variables is found by the estimation of the relationship between exchange rate and economic growth, the method employed to brand the estimation is the Dynamic Ordinary Least Square (DOLS), this method of testing was first introduced by Saikkonen (1991) and Stock and Watson (1993) and which was later extended to panel analysis by Kao and Chiang



The DOLS model can be formulated as follows;

$$GDP_{it} = \alpha_{it} + \beta_1 K_{it} + \beta_2 G_{it} + \beta_3 GDP0_{it} + \beta_4 INF_{it} + \beta_5 GDPOP_{it} + \beta_6 FDI_{it} + \sum_{j=-q}^p \varphi_{ij} \Delta LK_{it-j} + \sum_{j=-q}^p \partial_{ij} \Delta LRT_{it} + \sum_{j=-q}^p \phi \Delta EX_{it} + \sum_{j=-q}^p \partial_{ij} \Delta L_{it} + \varepsilon_{it}$$

Whereas, p and q are considered as the number of lags and leads respectively. Where the motive of the use of lag and lead is to capture serial correlation and endogeneity of the regresses that could result in unbiased estimation. The use of DOLS is pretended, even if the variables are co-integrated or may have the problem of endogeneity, the results obtained would still be unbiased. Moreover, the approach does not need the use of instrumental variables nor homogeneity assumptions and would still give robust results when there is the omission of variables that are not co-integrated.

**3.2.5 Granger Causality**

Lastly, once a co-integration relationship exists between two series, there is a causal effect among the variables of the repressors. The next stage is to apply the Granger causality test. The granger causality (Granger 1988) test was performed only on co-integrated variables to examine causal relationships among variables. The Granger method (Granger, 1988)

seeks to determine how much of a variable, Y, can be explained by past values of Y and whether adding lagged values of another variable, X, can improve the explained power. Once the panel co-integration test is complete, this study is will systematically to undertake the granger causality test to test the casual direction between economic growth, exchange rate, labor, capital and real interest rate in the ECOWAS countries.

**CHAPTER FOUR**

**4. Empirical Results**

Table 1 shows the result for the presence of unit root test by using the LLC test method. The results above indicate that the null hypothesis cannot be rejected at level form. Nevertheless, rejection of the null hypothesis of unit root occurs when taken the first difference. Therefore, the results are essential evidence indicating that all the variables are stationary at first order difference I (1).

**Table 1: Panel unit root results (level and first difference)**

Variable	LEVEL		FIRST DIFF			No. OF COINTEGRATION
	CONSTANT	CONS&TREND	CONSTANT	CONS&TREND	P-VALUE	
LGDP	0.22296	0.4118	-2.09114	-2.672282	0.0000**	I(1)
LK	1.44358	0.9256	-8.20743	-2.990651	0.0051**	I(1)
LRT	-0.93579	0.1747	-12.4240	-1.846951	0.0009**	I(1)
EX	-0.006538	0.1432	-3.01361	-1.734720	0.0015**	I(1)
L	1.90295	0.9715	-5.78156	-2.057698	0.0000**	I(1)

**Source:** Author’s computation

**Note:** \* denoted a 5 percent significance level.

Testing for the presence of a long-run relationships among variables that said to be integrated of the same variables by the use of panel cointegration techniques, were these variables have both a time-series dimension, at time T, and a cross-section of heterogeneity observations of the same dimension, N, has received much concentration in literature because of significant increase power that may be gained by not only accounting for the time series dimension but to also give an account for the cross-sectional

heterogeneity observations dimension. Despite the fact of the non-rejection of the null hypothesis of cointegration by many studies is strongly suggested by Theory. After getting strong evidence that all series are cointegrated at the order **I(1)**, the Pedroni co-integration test were used for this study for the existence of a long-run relationship among the non-stationary variables. Table 4.3 shows the results for the co-integration test.



**Table 2: Pedroni panel cointegration results**Pedroni Residual Cointegration Test  
Independent Variables: LK LRT L EX

Statistic	Statistic	Prob.
Panel v-Statistic	4.372234	0.0000*
Panel rho-Statistic	2.840881	0.9978
Panel PP-Statistic	-1.211905	0.1128
Panel ADF-Statistic	-3.269105	0.0005*
Group rho-Statistic	3.490268	0.9998
Group PP-Statistic	-1.135141	0.1282
Group ADF-Statistic	-3.669940	0.0001*

**Note:** \* denoted 5% (percent) significance level.**Source:** Author computation

Deterministic intercept and trend employ four-panel statistics and three group statistics to determine the status of the null hypothesis which states that there is no co-integration among the residuals of the variables against the alternative hypothesis showing that there is co-integration. Whereas giving statistical evidence of the case panel on the rejection of the null hypothesis nor fail to reject the null hypothesis, the first-order autoregressive term it is expected for the results across countries to be the same, in the parameters of a group panel statistics the first-order autoregressive term is allowed to vary across countries.

Table 2: Shows that panel co-integration test serve as a statistical evidence on both AR coefficients (between-dimension) and group statistics for co-integration between the variables, evidenced by results the null hypothesis is strongly rejected of co-integration in panel v-Statistics, panel ADF-Statistics, and Group ADF statistics, therefore panel v-Statistics, panel ADF-Statistics, and Group ADF statistics are all rejected at both 5 and 10 percent level of significance. Substantively, the results provided by panel co-integration test shows significance in one of the groups and two of the statistics panel, making it sufficient to say that variables in the growth model are co-integrated with each other.

Table 3: shows the results of the exchange rate and economic growth model for the fifteen ECOWAS member countries based on the DOLS estimator. This method of estimation requires the conclusion of leads and lags to avoid the autocorrelation problem among both the explained and the explanatory variables and to also capture the endogenous of the independent variables. To get the robust results of the estimation of

the lags and leads, by using one-year lags and one year of lead DOLS (1, 1).

Therefore, the estimated result shows clearly that there are negative relationships between the following real interest rate, exchange rate, and economic growth, which implied that a one percent (1%) increase in real interest rate and exchange rate leads to 20, and 0.6 percentages decrease in economic growth (GDP) respectively among ECOWAS countries but they are statistically significant at both 5 and 10 percent level. This simply implies that the impact of exchange rate excitability has a negative influence on the economic growth of these ECOWAS member countries.

To analyze the relationship between exchange rate and economic growth with the new growth theory, it is noted that the two variables (the exchange rate and growth) do not support the new growth theory were increasing in exchange rate automatically negatively affects the long-run growth of the economy through its effects of capital change. This result is regarding the findings provided by (Olisaemeka, Camillus and Nwakoby (2017 and Cassell, 2016) which indicate that there is a negative relationship between inflation and economic growth.

On the contrary, the results concerning the impact of exchange rate on economic growth ECOWAS member countries contrast with previous studies as they suggested that exchange rate on economic growth in ECOWAS member countries (O. O. Nathaniel, O. I. Oladiran and A. T. Oldiran (2019)) which a positive implies that an increase in the exchange rate leads to an increase in economic growth among countries in West Africa relying their results on



study such as McKinnon (1963) concluded that “where countries are small, a fixed exchange rate mechanism may help to maintain liquidity and prevent capital flight” and Kenen (1969) who opined that “where countries are less diversified and less equipped with policy instruments, they should make more frequent changes or perhaps resort to flexible exchange rates”.

This study strongly opposed the view put forth on the positive relationship between the two variables by (McKinnon (1963), Kenen (1969) and O. O. Nathaniel, O. I. Oladiran and A. T. Oldiran (2019)) in that increase in exchange rate in the presence of globalization of the economic activities implies the depreciation of country’s currency mostly due to the negative trade balances. Moreover, West African countries majority of their export products are primary commodities and the values of imported fished goods are greater than export causing depreciation in these ECOWAS member countries’ currencies, therefore policymakers cannot rely on the positive relationship among the two variables (exchange rate and economic growth) in a developing economy region like West Africa.

Moreover, the result also shows that an increase in the level of per capita income (LK) and labor shock will lead to an increase in the economic growth of the Western region of Africa A percent (1%) increase in

per capita income and labor leads to 0.41, and 0.24 percentages increase in economic growth (GDP) respectively among ECOWAS countries but they are statistically significant at both 5 and 10 percent level. This revealed a positive relationship between per capita income, labor, and economic growth also statistically significant at both 5 and 10 % (percent) level respectively. Furthermore, this findings certainly supported the a study done by Alagidede and Ibrahim (2016) they intimated in their finding that excessive volatility in exchange rate is disadvantageous to economic growth, an effective monetary policy requires policymakers to factor capital accumulation and exchange rates in particular in setting monetary policy instrument as this is a conduit to inflation targeting. This result is also consistent with previous findings by Jibrin and Jelilov ( 2017).

Meaning that in order to have an effective macroeconomic performance among developing countries and the ECOWAS countries per capita income and labor should be considered as a significant factors in the process of monetary policy formulation in the stimulation of economic growth this result is consistent with Levy-Yeyati and Sturzenegger (2003) they highlighted that elastic exchange rate regimes are related with low economic growth in developing countries.

**Table 3: Results of DOLS estimate of the long run effect of Exchange rate and Economic growth for ECOWAS countries**

Variable	Coefficient	Std. Error	t-Statistic	Prob.
LK	0.408803	0.013295	30.74951	0.0000**
LINTR	-0.200589	0.050898	-3.941028	0.0001*
EX	-0.006538	0.001073	-6.092358	0.0000**
L	0.244771	0.053833	4.546879	0.0000**

**Note:** \* and \*\* reject the null hypothesis of the co-integration at 5 and 10 % respectively significant level.

**Source:** Author Computation.

According to the results of the co-integration test, it is certainly concluded that both dependent and independent variables in the model are co-integrated, and consequently making then causally related to each other. The Granger causality testing method is employed to examine the direction of the causal relationship among the variables.

Table 4 below displays the results of the Granger causality test, which implies that there is the existence

of unidirectional causality relationship between exchange rate and economic growth, this results obtained from the test give concert support to the hypothesis that exchange rate increases economic growth, which is suggested by endogenous growth theory. Moreover, the increase in exchange rate gives a clear indication that the country’s macroeconomic performance is not strong enough to increase gross fixed capital and enlighten the country's economic



weakness highlighting among the Economic Community of West African States (ECOWAS).

**Table 5: Granger Causality Test**

<b>Null Hypothesis:</b>	<b>Obs</b>	<b>F-Statistic</b>	<b>Prob.</b>
LINTR does not Granger Cause LGDP	120	3.11770	0.0012**
LGDP does not Granger Cause LRT		1.61547	0.1062
LK does not Granger Cause LGDP	120	3.67129	0.0002*
LGDP does not Granger Cause LK		0.81014	0.6298
L does not Granger Cause LGDP	120	1.66757	0.0924**
LGDP does not Granger Cause L		1.20200	0.2961
EX does not Granger Cause LGDP	120	0.35487	0.9699
LGDP does not Granger Cause EX		0.84398	0.5970
LK does not Granger Cause LRT	120	2.29546	0.0153**
LINTR does not Granger Cause LK		1.23641	0.2738
L does not Granger Cause LINTR	120	0.60786	0.8181
LINTR does not Granger Cause L		2.77876	0.0035**
EX does not Granger Cause LINTR	120	1.54120	0.1293
LINTR does not Granger Cause EX		2.00159	0.0362
L does not Granger Cause LK	120	1.00807	0.4452
LK does not Granger Cause L		1.78896	0.0662
EX does not Granger Cause LK	120	0.95958	0.4882
LK does not Granger Cause EX		2.14009	0.0242
EX does not Granger Cause L	120	0.66197	0.7708
L does not Granger Cause EX		0.79316	0.6463

*Note:* \* and \*\* represent statistical significance at 10% and 5% respectively.

*Source:* Author computation

To Summarized the results of the Granger causality test, show that it is unidirectional between economic growth and real interest rate whereby only the decrease of real interest rate leads to economic growth. Additionally, the result shows that there is a unidirectional causal relationship between economic growth and capital stocks, whereas, the increase in economic growth causes the growth in capital accumulation. Moreover, the result also shows that there is a unidirectional causality between economic growth and labor, wherein, rise in economic growth certainly leads to an increase in effective labor at 5% significant level in ECOWAS countries during the

period of study. However, these results support the neoclassical growth model.

## 5. CONCLUSION AND POLICY RECOMMENDATION

This study explicitly examined the impact of exchange rate on economic growth in West African countries; these results have proven the significance of the observation of exchange rate movements as a major determinant for the formulation of effective monetary policy in order to have a smooth economic growth in developing countries. This result also showed that, exchange rate as a strong indicator for the



determination of key economic growth in ECOWAS countries.

In an act of contributing to existing knowledge, this study used a sample of all of the fifteen (15) ECOWAS countries for the period that runs from 2000-2018 to assess the relationship of exchange rate on economic growth in ECOWAS countries. The results also proved the statistical significance relationship and Granger causality between the exchange rate and economic growth within ECOWAS countries. These results imply that the exchange rate can negatively influence economic growth in these countries, most especially countries that have low capital accumulation and technological improvement and highly relied on the importation of goods and services. However, the results also proved a positive relationship between capital and economic growth. In order, to have a healthy and robust economic growth in developing countries, especially with ECOWAS member countries there is a need for the government of these countries to create an enabling environment for investment and concentrate on the advancement of effective labor (technology and labor), political stability and promote the rule of law. Finally, ECOWAS member countries should muster the courage of creating enabling environment more investments in the major sectors of the individual member countries, such as agriculture, manufacturing, infrastructural development, health, education, and in research and development to facilitates growth and development in order to promote the economic integration drive within the region.

## REFERENCES

1. Baltagi, B.H, 1995, "Econometric Analysis of Panel Data" (John Wiley, Chichester).
2. Clark (1973). *Uncertainty, Exchange Risk, and the Level of International Trade*. *Western Economic Journal*, 11: 302-313
3. Cushman, David O. 1983. "The Effects of Real Exchange Rate Risk on International Trade." *Journal of International Economics* 15 (August): 45-63.
4. Cushman, David O. 1986. "Has Exchange Risk Depressed International Trade? The Impact of Third-Country Exchange Risk." *Journal of International Economics* 5 (September): 361-79.
5. Granger, C.W.J. (1969). "Investigating Causal Relations by Econometric Models and Cross Spectral Methods" *Econometrica* 35, 424-438.
6. Hondroyannis & P.A.V.B. Swamy & George S. Tavlak & Michael Ulan, 2005
7. Hooper, P., and S.W. Kohlhagen. 1978. "The effect of exchange rate uncertainty on the prices and

volume of international trade". *Journal of International Economics*, 8: 483-511.

8. Kenen, P. B. (1969). *The theory of optimum currency areas: An eclectic view*, in Mundell, R. A. & Swoboda, A. K., editors, *Monetary Problems of the International Economy*. The University of Chicago Press.
9. O. O. Nathaniel, O. I. Oladiran and A. T. Oldiran (2019). "Impact of Exchange Rate Regimes on Economic Integration in the ECOWAS (1980-2017)"
10. Levine, A., Lin, C. F. and Chu, C. S. (2002). "Unit root tests in panel data: asymptotic and finite sample properties" *Journal of Econometrics* 108, 1-24.
11. Makin, John H. 1978. "Portfolio Theory and the Problem of Foreign Exchange Risk." *Journal of Finance* 33 (May): 517-34.
12. McKinnon, R. I. (1963). *Optimum currency areas*. *The American Economic Review* 53(4), 717-725
13. Levine, A., Lin, C. F. and Chu, C. S. (2002) "Unit root tests in panel data: asymptotic and finite sample properties" *Journal of Econometrics* 108, 1-24.
14. Tenreyro. S (2007) *On the Trade Impact of Nominal Exchange Rate Volatility* "Journal of Development Economics, March 2007, Vol. 82, No. 2: 485-508.
15. Nucci, F. & Pozzolo, A. F. (2001). *Investment and the exchange rate: An analysis with firm-level panel data*, *European Economic Review*, 45, 259-283.



## AUDIT FEES AND AUDIT REPORT LAG

**Dr. Patrick Amaechi Egbunike**

*Associate Professor Department of Accountancy, Nnamdi Azikiwe University, Awka*

**Peace Asuzu**

*Ph.D Research Scholar, Department of Accountancy, Nnamdi Azikiwe University, Awka*

### ABSTRACT

*Over the years, shareholders and other users of accounting information look to independent parties, the auditors for the certification of financial statements with regards to truth and fairness. The auditors, in exchange for this service are paid consideration which is referred to as audit fees. The study sought to determine whether the audit fees is a determining factor of how long it takes to prepare the audit report (Audit Report Lag). Thirteen manufacturing companies in the industrial sector were selected for the study. The descriptive statistics, Hausman test and panel regression were used for data analyses. Results showed that audit fees had a negative but insignificant effect on audit report lag. It was recommended that firms should get an optimal amount for audit fees to ensure they do not spend more than necessary while not compromising audit quality.*

**KEYWORDS:** *Audit, Audit fees, Audit report lag,*

### 1.0 INTRODUCTION

Financial statements serve as media through which directors provide users of accounting information with information relating to the financial position, financial performance and cash flows of the entity (Shehu & Musa, 2014). In relation to the agency theory, the management team acts as agents to shareholders and have their own interest to protect. Past scandals such Enron, Worldcom have revealed that there are tendencies for management to window-dress information to give false impression on the performance of the firm. These tendencies continually raise the need for independent parties to review financial reports and give opinions on the truth and fairness of the reports in reporting what they purport to. The opinions given bring a level of credibility of these reports. This is supported by Fagbemi, Abogun, Uadiale and Uwuigbe (2013) when they stated that the quality of audits and audit opinions expressed on financial reports are crucial to achieving sustained investors' confidence.

Audit involves in the thorough examination of a set of information, procedures and processes to express an opinion on the state of such. It could be conducted on various aspects and functions of the organization. In this study, audit refers to the examination of financial statements by external independent parties also referred to as statutory audit. Farouk and Hassan (2014) stated that external audits performed in accordance with high quality auditing standards can promote the implementation of accounting standards by reporting entities and help ensure that their financial statements are reliable, transparent and useful. Sound audits also help reinforce strong corporate governance, risk management and internal control at firms, thus contributing to financial performance (Internal Audits Board, 2011).

External audit is conducted by external accountants (usually audit firms) expected to be independent. In exchange for their services, they are given consideration for the services they render. In





other words, they are paid for their services of thorough examination of financial statements and procedures employed in the preparation of the reports by directors to express an opinion on the truth and fairness of the financial statements. Basioudis, Geiger and Papanatasiou (2006) opine that the growing fees charged by auditors have raised more attention over the years in relation to how it will affect auditor independence.

Audit exercises have allotted periods stated in the audit plan. The end of the exercise usually approaches with the issue of an audit report which contains the auditor's opinion on the financial statements. The period it takes to issue a report is referred to as the audit report lag. It should be noted also that financial statements cannot be published or filed without the audit report. Thus, audit report lag is a cause of concern for management to ensure that they follow statutory rules [such as tax filing; submission at Securities and Exchange Commission; and Corporate Affairs Commission] and avoid penalties associated with defaults. Only a few studies are found in Nigeria to have examined the effect of audit fees (not used as a proxy to auditor independence) on audit report lag. As such, the objective of this study is to:

*Ascertain the effect of audit fees on audit report lag in manufacturing companies in the industrial goods sector.*

The remainder of this paper is divided into three sections. The first section examines the theory that underlies the study, explains the study concepts and shows a review of related studies. The second section outlines the study sample, scope and data analyses employed. The third section explains the findings of the study while the last section contains concluding statements and recommendations made based on findings.

## 2.0 LITERATURE REVIEW

### Theoretical Framework

External audit has its root in the tenets of agency theory propounded by Jensen and Meckling (1976). The agency relationship is a contract under which one or more persons (shareholders) engage another person (directors and management) to perform some service on their behalf, which involves delegating some decision-making authority to the agent (Jensen & Meckling, 1976). These agents in the course of their agency activities have to choose between acting in their best interests or the best interests of shareholders. To reduce the negative impact of management looking all out for themselves to the detriment of the investment of shareholders, independent auditors are engaged to give

an opinion of the truth and fairness of financial statements prepared by directors. Shareholders have to bear agency costs to ensure that the reports given by management on their investments are true and fair. These costs include the engagement of external auditors. Watts (1998) stated that audit fees are paid to independent auditors is a bonding cost paid by agents to a third party to satisfy the principals' demand for accountability. The auditors in exchange for the fees, carry out audit procedures within projected time frame before issuing a report on the state of financial affairs reported by management.

### Audit Report Lag

Financial statements are prepared by directors and dated at the end of the financial year. However, these financial statements cannot go public without the certification of independent auditors. Before these auditors or audit firm issue a report on the financial statements, they examine the books and other necessary procedures. This period taken between the end of the financial year and the date of issuance of the audit report is referred to as audit report lag. Ezat (2015) defines audit report lag as the period from the closing date of the balance sheet to the signed audit report date. This study is concerned with how long it takes for the audit report to actualize.

Audit report lag raises an important characteristic of accounting information, which is timeliness. Usman (2014) opined that timely publication of financial information of a company depends very much on the time taken to complete the audit as financial statements cannot be issued until the audit has been concluded. It should be called to mind that accounting information is only relevant when it is timely. In other words, once the reports cannot aid decision making on the part of users, it is not relevant.

All things being equal, all companies should seek to minimize their audit lag in order to enhance market efficiency (Usman, 2014; Ezat, 2015). Abdulla (1996) reported that a shorter audit report lag increases the benefits derived from the audited annual reports. As a result, companies may exert some pressure on their independent auditors to finalize the audit as quickly as possible (Ezat, 2015) though it may be for other purposes such as tax computations. Amirul and Salleh (2014) raise a concern that longer audit report lags could lead to information asymmetry and higher uncertainty associated with investment decisions. Auditors on the other hand, might be less aggressive about audit report lag because they want to exercise professionalism and due care in the engagement to avoid the risk of litigation. Ezat (2015) stated that



auditors prefer to spend more time and effort to avoid such risks which may increase the audit report lag.

Previous studies show varying spans of audit lag amongst Nigerian firms. Oladipupo (2011) found that the audit report lag spans from 16 - 284 days. Modugu, Erahbhe and Ikahtua (2012) found it spans from 30 to 276 days.

### **Audit Fees**

Audit fees are the amount paid to financial auditors for the certification of financial statements (International Standards on Auditing, 2011). Choi, Kim, Lin and Simunic (2009) defined audit fees as fees provided to auditors that reflect the cost of the effort conducted by the public auditors and risks of litigation. Onaolapo, Ajulo and Onifade (2017) stated that audit fees differ in relation to complexity of audit, risk of the engagement, the audit firm, professionalism required and other professional factors. It includes direct work hours' fees, other direct costs (for instance extra fees of off-center mission and transportation) and allocable overhead (Abbaszadeh, 2017). Simunic (1980) attributed the fees to the contract between the auditor and client taking into consideration audit period and services. Gandia and Huguet (2019) stated that higher audit fees may be perceived as the result of a more effective monitoring by the auditor, and a consequence of the audit effort (more work hours) and the auditor experience (higher fees per hour). Onaolapo et al (2017) examined the effect of audit fees on audit quality in Nigeria using a sample of listed cement companies on the floor of the Nigerian Stock Exchange. Findings from the study show that audit fee shows a significant positive impact on audit quality

### **Audit Fees and Audit Report Lag**

Habib, Bhuiyan, Huang and Miah (2019) opined that clients may be willing to pay higher fees for a quicker completion of audit procedures. This, Rubin (1992) states will cater for additional staff, overtime and more concentrated audit resources resulting in shorter period in which the audit report will be ready. Leventis, Weetman and Caramanis (2005) found that payment of a high audit fee can reduce the audit report lag of listed firms on the Athens Stock Exchange. Abbaszadeh (2017) reported a negative and significant relationship between the audit fees and delay in audit reports. Overall, these studies report negative association between audit fees and audit report lag. In line with this, the study hypothesis is formed:

*Ho: Audit fees has a significant negative effect on audit report lag*

Other studies suggest a positive association between audit fees and audit report lag. Lobo and Zhao (2013) attributes higher audit fees to extra and more

detailed audit effort needed which will tend to cause the audit process to drag, hence a longer audit report lag. Defond & Zhang (2014) also stated that high audit fees will facilitate the assignment of qualified auditors who will use more time to ensure they detect mistakes and errors in the financial statements.

### **Empirical Review**

Modugu et al (2012) studied the relationship between company characteristics and audit delay in twenty sampled companies on the Nigerian Stock Exchange using 2009 to 2011 financial data. The study sought to determine average audit lag in Nigeria and the effects of company characteristics in predicting that lag. The company characteristics studied were: audit fees, company size and multi-nationality of firm. measure the extent of audit lag in Nigeria and to establish the impact of selected corporate attributes on audit delay in Nigeria. Audit lag for studied companies had a minimum value of 30 days and a maximum of 276 days. Averagely, Nigerian listed companies take approximately two months after year end to present audited accounts. Ordinary Least Square regression results showed audit fee is one of the major determinants of audit delay in Nigeria. It was recommended that regulatory authorities have mechanisms in place to probe abnormal audit delay.

Rahmina and Agoes (2014) investigated the effect of audit fee, audit tenure and auditor independence partially and simultaneously on the audit quality through primary data acquired from questionnaires. Distributed to audit firms in Indonesia. Respondents comprised senior auditor, supervisors, managers, and partners who had worked on the audit firm member of FAPM. Auditor independence, audit tenure, and audit fee were all found to have positive influence on audit quality.

Oladipupo and Monye-Emina (2016) examined the effect of abnormal audit fees on audit quality in the Nigerian audit market. The study employed the probit binary regression technique on analyses of 350 firm observations extracted from listed Nigerian companies. Results showed that both positive and negative abnormal audit fees had positive but insignificant impact on audit quality. This shows that abnormal audit fee does not matter to audit quality.

Onaolapo et al (2017) examined how audit quality is affected by audit fees in listed cement-producing companies in Nigeria using data from annual reports from 2010 to 2015. Audit fees, leverage ratio, client size and audit tenure were independent variables while audit quality formed the dependent variable. For analysis, Ordinary Least Squares regression was employed. Findings from the study show that audit fee



and other independent variables considered have a joint significant effect on audit quality. They recommended that policies that could improve audit quality should be adopted by government in Nigeria.

Ilechukwu (2017) examined the effect of audit fee on the audit quality of firms in the Nigerian consumer goods industry. Data were extracted from annual reports of sampled firms from 2011 to 2016. Audit fee and audit tenure were the independent and dependent variables respectively. The core explanatory variables employed were the audit fee and audit tenure. Firm size, leverage and profitability were controlled for in the pooled data ordinary least squares regression model. Findings revealed that audit fee has a positive but insignificant effect on the audit quality of consumer goods sector of quoted firms in Nigeria.

### 3.0 METHODOLOGY

The study was conducted on a sample of thirteen listed industrial goods companies using annual reports for 5 years from 2014 to 2018 using the *ex-post facto* research design. Data extracted from annual reports were analysed using descriptive statistics, hausman test and panel regression. The study employed a regression model:

Where:  $AF$  = Audit fees;

$ARL$  = Audit report lag (number of days between year end and date of signed audit report);

= constant; =co-efficient; = error term

## 4.0 RESULTS

**Table 1: Descriptive Statistics**

	AUDIT FEES	ARL
Mean	53313463	87.83582
Median	10800000	89.00000
Maximum	5.39E+08	180.0000
Minimum	300000.0	37.00000
Std. Dev.	1.16E+08	20.80836
Jarque-Bera	239.5114	220.5487
Probability	0.000000	0.000000

Source: E-Views 9

**Table 2: Correlated Random Effects - Hausman Test**

Equation: Untitled

Test cross-section random effects

Test Summary	Chi-Sq. Statistic	Chi-Sq. d.f.	Prob.
Cross-section random	0.485800	1	0.4858

Source: E-Views 9

The result of the hausman test show that  $X^2 = 0.4858$ ;  $p > .05$ ; Therefore, Random Effects Panel Regression is more suitable than Fixed Effects Panel regression.

**Table 3: Panel Regression**

Dependent Variable: ARL

Method: Panel EGLS (Cross-section random effects)

Date: 03/20/20 Time: 00:18

Sample: 2014 2018

Periods included: 5

Cross-sections included: 14

Total panel (unbalanced) observations: 67

Swamy and Arora estimator of component variances

Variable	Coefficient	Std. Error	t-Statistic	Prob.
C	88.08445	3.805705	23.14537	0.0000
AUDIT_FEES	-5.69E-09	2.90E-08	-0.196570	0.8448
Effects Specification				
			S.D.	Rho
Cross-section random			9.690848	0.2078
Idiosyncratic random			18.92413	0.7922
Weighted Statistics				
R-squared	0.000602	Mean dependent var	58.16074	
Adjusted R-squared	0.000174	S.D. dependent var	18.74889	
S.E. of regression	18.80410	Sum squared resid	22983.61	
F-statistic	0.039135	Durbin-Watson stat	1.911657	
Prob(F-statistic)	0.843799			
Unweighted Statistics				
R-squared	0.002752	Mean dependent var	87.83582	
Sum squared resid	28498.56	Durbin-Watson stat	1.541719	

*Source: E-Views 9*

The independent variable, audit fees was found to have a co-efficient of -0.0000000569. this showed an inverse association of audit fees and audit report lag. Higher audit fees caused a reduction in time taken for audit while lower fees increased lengthened the report lag. This was however not to a significant level as depicted by p value of t statistic of 0.84 ( $p > .05$ ). The constant value was 88, which is found to be significant ( $p < .05$ ). Thus, when audit fees are at the barest minimum, a typical audit report lag is 88 days. This reduces though insignificantly as audit fees rise. Durbin- Watson statistics, 1.91, rules out the presence of autocorrelation ( $DW < 2$ ). The R square statistic revealed that audit fees are responsible for just 0.06%

variation in audit report lag. The model is insignificant as portrayed by the p value of F statistics, .84 ( $p > .05$ ).

Decision Rule: If the P-value is less than the Alpha ( $\alpha$ ) value of 0.05, reject the Null Hypothesis. If the P-value is greater than the Alpha ( $\alpha$ ) value of 0.05, accept the Null Hypothesis.

Hence, the null hypothesis is accepted that audit fees have no significant effect on audit report lag in manufacturing firms in Nigeria.

## 5.0 CONCLUSION AND RECOMMENDATIONS

This study serves as an exposition on the effect of audit fees on time taken for audit engagement. A



negative but insignificant association was found between audit fees and audit report lag. The implication of our findings is that auditors carry out their engagements irrespective of how much they are paid. Auditors take time to audit companies and prepare report because they want to avoid litigation costs that can accrue if they issue misleading reports and not because they feel they are underpaid. Longer audit report lags are more likely to be attributable to red flags found in financial statements prepared by directors and more thorough examinations of suspicious areas. The study is significant to top management as it provides empirical evidence on the relationship between audit fees and audit report lag; and the need for cost management as audit fees do not influence audit report lag. Future researchers can also use this work as a reference point for further research on related studies.

In line with findings, it is recommended that firms should get an optimal amount for audit fees to ensure they do not spend more than necessary while not compromising audit quality. Further studies can be undertaken on other specific factors that affect audit report lag in manufacturing companies. The study is limited to listed manufacturing industries. The findings should be treated with requisite prudence when applying it to other firms that do not fall under the sample category.

## REFERENCES

1. AbbasZadeh, R. (2017). *An empirical study: The effect of audit fees and risk on the quality of financial reporting*. *Revista QUID (Special Issue)*, 2888-2893.
2. Abdulla, J.Y.A. (1996). *The timeliness of Bahraini Annual Reports*. *Advances in International Accounting*, 9, 73-88
3. Amirul, S. M., & Salleh, M. F. (2014). *Convergence to IFRS and audit report lag in Malaysia*. *Research Journal of Finance and Accounting*, 5(23)
4. Basioudis, I.G., Geiger, M.A. & Papanastasiou, V. (2006). *Audit fees, non-audits and auditor reporting on UK stressed companies*. Paper presented at the *International Auditing Conference, University of Manchester*
5. Choi, J.H., Kim, J.B., Liu, X. & Simunic, D.A. (2009). *Cross-listing audit fee premiums: Theory and evidence*. *The Accounting Review* 84, 1429-1463.
6. DeFond, M., & Zhang, J. (2014). *A review of archival auditing research*. *Journal of Accounting and Economics*, 58(2-3), 275-326.
7. Ezat, J.A. (2015). *The impact of audit-related factors on audit report lag for the Egyptian listed non-financial companies*. *Journal of the Faculty of Commerce for Scientific Research*, 1-46
8. Fagbemi, T.O., Abogun, S., Uadiale, O.M. & Uwuigbe, O.R. (2013). *An assessment of audit approach and audit quality in Nigeria*. *Research Journal of Finance and Accounting*, 4(14).
9. Farouk, M. A. & Hassan, S. U. (2014). *Impact of audit quality and financial performance of quoted cement firms in Nigeria*. *International Journal of Accounting and Taxation*, 2(2), 1-22.
10. Gandía, J.L. & Huguet, D. (2019). *Audit fees and cost of debt: differences in the credibility of voluntary and mandatory audits*. *Economic Research-Ekonomska Istraživanja*, DOI: [10.1080/1331677X.2019.1678501](https://doi.org/10.1080/1331677X.2019.1678501)
11. Habib, A., Bhuiyan, M.B.U., Huang, H.J. & Miah, M.S. (2019). *Determinants of audit report lag: A meta-analysis*. *International Journal of Audit*, 23, 20- 44. <https://doi.org/10.1111/ijau.12136>
12. Ilechukwu, F.U. (2017). *Effect of audit fee on audit quality of listed firms in Nigeria*. *International Journal of Trend in Research and Development*, 4(5), 319-326
13. *International Auditing and Assurance Standards Board*. (2011). *Audit quality: An IAASB perspective*. New York.
14. *International Standards on Auditing* (2011).
15. Jensen, M. & Meckling, W. (1976). *Theory of the firm: Managerial behavior, agency costs and ownership structure*. *Journal of Financial Economics*, 3(4), 305-360.
16. Leventis, S., Weetman, P. & Caramanis, C. (2005). *Determinants of audit report lag: Some evidences from the Athens stock exchange*. *International Journal of Auditing*, 9 (1), 45-48
17. Lobo, G. J. & Zhao, Y. (2013). *Relation between audit effort and financial report misstatements: Evidence from quarterly and annual restatements*. *The Accounting Review*, 88(4), 1385-1412.
18. Modugu, P.K., Eragbhe, E. & Ikhata, O.J. (2012). *Determinants of Audit Delay in Nigerian Companies: Empirical Evidence*. *Research Journal of Finance and Accounting*, 2(3), 3-9.
19. Oladipupo, A.O. (2011). *Impact of corporate international linkage on the incidence of audit delay in Nigeria*. *Journal of Research in National Development*. 1(9), 24-32.
20. Oladipupo, A.O. & Monye- Emina, H.E. (2016). *Do abnormal audit fees matter in Nigerian audit market? International Journal of Business and Financial Management Research*, 4, 64-73.
21. Onalapo, A.A., Ajulo, O.B. & Onifade, H.O. (2017). *Effect of audit fees on audit quality: Evidence from cement manufacturing companies in Nigeria*. *European Journal of Accounting, Auditing and Finance Research*, 5(1), 6-17
22. Rahmina, L.Y. & Agoes, S. (2014). *Influence of auditor independence, audit tenure, and audit fee*





---

*on audit quality of members of capital market accountant forum in Indonesia. Procedia-Social and Behavioral Sciences 164, 324 – 331.*

23. Rubin, M.A. (1992). *Municipal selection of a state or external auditor for financial statement audits. Journal of Accounting and Public Policy, 11(2), 155–178.*
24. Shehu, U.H, & Musa, A.F. (2014). *Audit quality and financial performance of quoted cement firms in Nigeria. European Journal of Business and Management, 6(28), 73-82.*
25. Simunic, D. (1980). *The pricing of audit services: Theory and evidence. Journal of Accounting Research, 18(1), 161-190.*
26. Usman, A. (2014). *Audit attributes and financial reporting quality of quoted food and beverages firms in Nigeria, M. Sc Thesis Department of Accounting A.B.U. Zaria*



# PECULIARITIES OF STRUCTURAL CHANGES IN THE MACHINE-BUILDING INDUSTRY OF UZBEKISTAN

**Khaydarov Khayrulla Gulamovich**

*Independent researcher of Tashkent State University of Economics, Tashkent, Republic of Uzbekistan*

Article DOI: <https://doi.org/10.36713/epra3871>

## ABSTRACT

*The article describes the specific methods and mechanisms of structural change in the mutually beneficial structure of machine-building enterprises of Uzbekistan, the provision of raw materials, the improvement of production of selected and new types of products.*

**KEY WORDS:** *competitiveness, modernization, diversification, stock market, marketing, modification, lender, assets, stocks, financial resources, investment, infrastructure.*

## INTRODUCTION

One of the main and most important principles in the effective implementation of structural changes in the economy is to take into account the specific characteristics of each sector. The role and importance of the industry in the national and foreign economy, its level of development, the characteristics of economic resources and other factors require the development and application of specific methods and tools, solutions and conclusions, mechanisms and supports of structural change. The Decree of the President of the Republic of Uzbekistan dated February 7, 2017 "On the Strategy of actions for further development of the Republic of Uzbekistan", which sets priorities for economic development and liberalization [1]. Enhancing the competitiveness of the economy through the deepening of structural changes, stimulating the localization of production, first of all, replacing the import of consumer goods and components, expanding the intersectoral industrial corporation are among the most important tasks.

## METHODS

Research aimed at strengthening cooperation in industries and sectors through modernization and diversification of the economy, targeted use of factors that increase the competitiveness of enterprises in domestic and foreign markets, increase the efficiency of production and technical factors - economists T.Ziyoev, Sh.Israilova [2], Studied by M.Sharifkhodjaev, Yo.Abdullaev [3]. Extensive research on the scientific and theoretical basis and specifics of the development and competitiveness of sectors of the economy was conducted by foreign economists - V. Biryukova, A. Akhtulova [4], N. Sayfulin [5].

## RESULTS AND DISCUSSIONS

It requires the introduction and effective implementation of a specific mechanism for assessing the methods and economic situation of structural changes in the engineering industry of Uzbekistan. In this regard, it is expedient to identify the existing shortcomings in the period of restructuring of the network, their causes and areas for solution (Table 1).

**Table 1. Existing problems, shortcomings and directions for their solution in the restructuring of the engineering network**

<b>Nº</b>	<b>Content of problems and shortcomings</b>	<b>Reason of origin</b>	<b>Solution directions</b>
1	Inadequacy of means of production in the industry	Business entity technical the structure is unreasonable	In terms of production at each enterprise in the industry: - means of production grouping; - lease or sale of unusable; -purchase of necessary equipment.
2	Lack of financial resources	Improper organization of production and sale of the product	-ensure the involvement of the industry's own funds in the necessary tasks in the plan of structural changes; - Document on providing financial resources for structural changes. This document is necessary for communication with organizations involved in lending.
3	Lack of staff to implement structural changes	Experienced in the network and there is an indifference to professional training	-involvement of qualified specialists in structural change (marketing, finance); -ensure that employees have experience in structural changes, training, etc.
4	Dependence of joint-stock companies on the stock market	Requires a large amount of money	-increase the efficiency of targeted direct investment.

As can be seen from the table above, the main shortcomings in the implementation of structural changes in the industry remain due to negative factors such as obsolescence of means of production (63.9%) [6], lack of funding and lack of qualified personnel. However, as a result of the

effective implementation of structural changes, we can achieve the following positive features (Table 2).

**Table 2. Making structural changes in the engineering industry positive directions of increase**

№	The content of the positive aspects	Objectives to be achieved
1.	Provides property reform and production restructuring during the period of sector restructuring and privatization	-formation of a layer of real owners in the enterprises of the industry; - formation of a competitive environment; - specialization of the industry in the production of components and finished products; -organization of effective production activities on successful structural changes in the economy.
2.	The network is constantly being reformed and moved to a new level in terms of quality	- Efficient use of production capacity and raw material resources will be established; - Intensive development of production and adaptability to market conditions; - balanced conditions of supply and demand; - Increased independence in the free choice of production and pricing.
3.	Structural changes include changes in the production program and innovations in related structures	- reorganization of the technical base of the network; - performs the function of social and labor distribution; -experienced and qualified staff is formed; -Involvement of financial (active and passive) funds in targeted plans and control over it will be strengthened.
4.	It is possible to perform strategically practical tasks in the network	- Agreements are made with partners in the country and abroad; -coordinates activities with structural units and subcontractors; - decision-making on joint ventures and the design and development of autonomous production units operating in the industry.

It is known that the enterprises of the machine-building industry of the Republic did not specialize in the production of components, and all the necessary parts were imported. As a result, the share of machinery and equipment in imports increased (CIS countries to 15.9%, other foreign countries to 58.8%) [7], the efficiency of the industry and development prospects remained dependent on foreign manufacturers. Accordingly, it is clear that today a large amount of money is required to restructure the machine-building industry, that is, to produce modern finished products, to attract equipment and technology. To do this, one of the most convenient ways of structural change is to improve the efficient use of internal resources of the network.

Overcoming the existing financial difficulties in the above-mentioned sector requires the application of well-designed and prompt measures. Because, first of all, it is necessary to improve the overall condition of the network through urgent measures, to improve the attitude of workers and other employees to production, the attitude of other industry towards this industry. This will ensure the reliability of the network to attract foreign investment. Second, the introduction of a production

project based on capital investments that will ensure the future of the industry will be achieved.

In the implementation of effective production projects, it is necessary to pay attention to the affiliation, diversification and ownership of activities. This, in turn, requires an assessment of the following priorities in the structure of the network:

- Grouping of types of products that do not meet the requirements of the world and national markets;

- improve the introduction of selected and new types of products;

- redistribution of equipment required for production and experienced managers, consultants, qualified personnel;

- It is necessary to improve the market-based management mechanism.

Structural changes in the industry depend in many respects on the composition and regional location of production. At the same time, it is important to eliminate regional disparities in production, mainly in the enterprises of the sector. First of all, based on the mutually acceptable structure of enterprises, the availability of raw materials and the development of priority areas of production in places where demand is high, the



following tasks need to be addressed based on the economic potential and social characteristics of the region. These are:

- re-evaluation of the development of raw materials processing industries in the region;
- organization of additional production enterprises;
- Ensuring the structure of labor resources in the regions, employment and integration of labor resources.

- However, the enterprises of the machine-building industry are not optimally located in the country today. It is an important solution to maintain the production of homogeneous products such as technical parts, spare parts, restoration of details of light industry, which are available in the regions, in the regions where they are most needed.

- In order to further improve the regional status of structural changes, it is necessary to organize new economic cooperation between large and medium-sized enterprises, based on objective market conditions. At the same time, the interaction of large and medium-sized enterprises with large enterprises should be based on the orders of large manufacturers. Because, first of all, it focuses on the production of consumer goods by small and medium enterprises. Second, the mutual integration of enterprises will deepen and regional economic cooperation can be ensured.

- It would be more appropriate if it is based on the stages of structural change, the initial stage of which includes measures to assess and improve the financial situation, marketing services, compliance of the administrative structure, market mechanism and elimination of weaknesses.

- In the process of structural change in enterprises, it is necessary to make an operational assessment of its market position, financial and economic activity and management efficiency.

- When assessing the market position of the enterprise, the following should be considered.

a) determine the position of the enterprise in the market by obtaining and analyzing the following information: On the indicators of economic development of industries and regions, the directions of state policy, which determines the production and sale of products and raw materials consumed by the enterprise;

- On the current level of production in the country, the volume of imports and exports of products and raw materials, as well as the volume of production of import-substituting products;

- about consumer and market segmentation;

- about the main classifications of the market for each segment (price elasticity of the resulting price, the potential and real capacity of the market, its saturation with products and goods);

- Geographical distribution of goods, export markets;

b) identification of competitors and analysis of their activities:

- general information about competitors (sales volume in the market as a whole and its segments, total market share, goals, market behavior, self-assessment, etc.);

- Strengths and weaknesses of competitors (product quality, pricing policy, movement of goods, sales policy, after-sales service, forms of live settlements, prepayment, extension of payment, etc.) ;

- Determining the level of competition of manufactured products in the commodity sector (pressure through substitute products, the ability of buyers and suppliers to come to an agreement).

c) to make optimistic, pessimistic and moderately limited forecasts of market development based on the results of marketing research, within each of which the following is recommended:

- determine the phases and duration of the life cycle for each type of product;

- assessment of potential risks of the enterprise.

The following indicators are taken into account when evaluating the management of the enterprise:

1. Attitudes towards changes in the business environment.

a) Is the problem the result of a change in the external situation or the result of a decrease in the overall work rate?

b) Did management identify change quickly or did they expect shortages to occur?

c) Does management have a clear, efficient and reliable strategy for solving problems?

d) Is a unified approach to the problems within the management structure clear?

e) Does the enterprise have the political power to influence the external factors of the problem?

2. Ability to control the enterprise.

a) Does the enterprise have a clearly defined business plan?

b) Does the enterprise have adequate financial control?

c) Does the enterprise have an adequate management function?





d) Is the enterprise doing any work to confirm that the workforce meets the requirements of the action?

e) Is the cash flow that is effective during the management period of the enterprise considered?

3. The ability to manage to get out of a crisis.

a) Can management clearly identify problems and take responsibility for solving them?

b) Is management capable of developing a realistic and effective recovery plan?

c) Is management able to repay the loan and support creditors?

d) The clarity of the entrepreneurial spirit and the existence of a clear path to recovery?

e) Does the management have the necessary technical skills, or are there significant interruptions in it?

When evaluating this process logically, the poor financial condition of the industry automatically requires a positive approach to it. To do this:

1) By redistribution of internal resources of the enterprise:

- Cash flow management;

- Cost reduction by identifying and preventing excessive costs and losses;

- Improving the expansion of the range of additional products in the revision of the list of product names;

2) Through property restructuring:

- Liquidation of unused assets and directing to the sale of inefficient fixed assets;

- Modification of production operations in order to reduce the temporary norms for the production shift of product parts. At the same time, the activities of economically insolvent enterprises and efficient enterprises should be changed in the following order.

Great attention should be paid to financial change in economically insolvent enterprises. Although the state rehabilitation program has been implemented and benefits have been provided to these enterprises, there is an inability to produce products. But it is difficult for lenders to operate without a reliable production plan, i.e. to lend money to enterprises undergoing structural change. To this end, it is advisable to implement a strategy option in a situation of structural change deficit. At the same time, it is necessary to strengthen control over the projected cash flows, interest rates (use of a single rate to determine the current value of investments). As a result, the interest rate charged should be the real value of the investment made in the investment.

In economically insolvent enterprises, a convenient method is to assess business value. In this regard, special attention should be paid to joint-stock companies. To do this, it is necessary to strengthen

product sales and advertising. The following options for financial change may yield the expected results. That is, the ratio of the value of private capital to debt. In the period of structural change, it is necessary not to reduce the current production, to involve the enterprise in the target plans of the industry by collecting receivables.

The reduction of production volumes during the period of structural changes can lead to negative consequences, firstly, a sharp decline in financial revenues in the industry, and secondly, the incomplete satisfaction of demand for the product in the country. To do this, it is advisable to continue production in the network in the following groups:

Mass production is defined by the division of the industry into a system of agriculture, consumer goods, industry and enterprises, associated with the production of a large volume of necessary products. In this case, the same labor operations are performed by a large number of workers. The advantage of mass production is that every technological operation performed is carried out using previously used equipment. In this case, the coefficient of action  $K_{ba}=1$  were marked.

**Single production** - specializes in the production, processing and repair of small parts. Provides a package of private and public orders. In this case, the next product may differ from the previous product. Through this method of production, the creation of products for the export of the industry can also be widely implemented. That is, the addition of mass and multiple production methods, as well as the implementation of production based on orders, will have a major impact on the growth and efficiency of network production. In turn, ensures the production of newly designed products and parts based on the scientific and technical process.

**Numerous production**-preparation and repair are characterized by recyclable products. The importance of determining the quantity of products produced will depend on the coefficient of action performed on a large number of different, medium and small-scale production. This process is very important during production, i.e. it can prevent overproduction and waste. Will be in constant contact with mass and single production teams in the implementation of production.

The amount of work performed in large-scale production during this period  $1 < K_{ba} < 10$ ,

For the production of a large number of medium  $10 < K_{ba} < 20$ ,

For the production of small numbers  $20 < K_{ba} < 40$  equal.

These normative indicators prevent inappropriate consumption of raw materials. In our opinion, it is necessary to study the investment market, strengthen the activities of joint ventures and



introduce a network design and engineering center in the country.

In the restructuring of the industry, it is necessary to pay special attention to the development of relations of large enterprises with small businesses and private entrepreneurship. That is, specialization through the transfer of certain parts of production to small and medium enterprises, it is expedient to use the benefits of inter-farm integration processes. Also, the transfer of some parts of production to small and medium-sized enterprises will reduce the cost of production, provide tax benefits. In addition, small and medium-sized enterprises are quick to adapt to the market and have the ability to meet them quickly by studying the needs of customers. It is expedient to establish relations with small and medium enterprises, first of all, in large enterprises of the industry. In addition, some enterprises in the industry are formed in the form of joint-stock companies, despite the small scale of production. It is known that joint-stock companies are the preferred form of full-fledged opportunities for large enterprises in terms of organizational and legal relations, because their management is relatively complex and its costs are high (for example, issuing shares, publishing information on shares, etc.). Therefore, medium-sized enterprises established in the form of joint-stock companies should be transformed into more limited liability companies. This is due to the fact that the industry is not flexible due to the fact that enterprises are accustomed to the production of products in large categories and in a variety of ways.

## CONCLUSION

By defining the specifics of the structural changes taking place in the machine-building industry, the role of the machine-building industry in the structure of the national economy will be increased. In order to achieve positions in domestic and foreign markets, methodological support will be provided to the network, overcoming internal infrastructure and resource constraints, and maintaining a balance between economic and social goals.

## REFERENCES

1. *Decree of the President of the Republic of Uzbekistan dated February 7, 2017 No PD-4947 "On the strategy of further development of the Republic of Uzbekistan".* www: Lex.uz
2. *T.Ziyoev, Sh.Israilova. Theory of industry and enterprise economics. Textbook.-T: TSU. 2011.*
3. *M.Sharifkhojaev, Yo.Abdullaev. Theory and practice of market economy.-T: Ukituvchi, 2000.*
4. *V. Biryukova, A. Akhtulova. Competitiveness of the Russian economy (theory, practice, trajectory of changes and ways to increase). Textbook / Under the general. ed.-Omsk: Publishing house of SibADI, 2005.*
5. *N. Saifulin. Competitiveness: theory and methodology / Monograph.-Kazan. Center for Innovative Technology. 2008.*
6. *Data of the Statistics Committee of the Republic of Uzbekistan.\*)By IFUT-2 classifier 25,26,27,28,29,30,33 activities. 2019.*
7. *Annual statistical collection of the Republic of Uzbekistan - T: 2019. Page 253.*



## THE OCTOBER REVOLUTION OF 1917 AND THE ESTABLISHMENT OF SOVIET POWER IN THE TURKESTAN TERRITORY

**Baxtigul Abdupattaevna Mamadaminova**

*Senior Lecturer, Department of Humanities, Institute of Irrigation and Agricultural Mechanization Engineers in Tashkent*

### ABSTRACT

*This article shows the October Revolution of 1917 and the establishment of Soviet power in the province. The events of February and October 1917, which occurred in Petrograd, had an impact on the Turkestan Territory. After the establishment of Soviet power, the position of political forces in the Khiva Khanate became apparent. After the Bolsheviks came to power, they began secretly preparing for the seizure of the Khiva khanate, as was done with the Bukhara emirate. The leadership of Soviet Turkestan and their military forces sought to seize the territory of the Khiva Khanate and the Bukhara Emirate, and create a revolutionary government there instead of these states.*

**KEYWORDS:** *Khiva Khanate, February Revolution, Turkestan, Turkestan ASSR, RSFSR, Turkestan Commission, Turkestan Front.*

### DISCUSSION

The echo of the February and October events of Petrograd echoed in its remote region of Turkestan. Taking power into their own hands, the Bolsheviks announced the establishment of Soviet power. After the establishment of Soviet power in Turkestan, the position of political forces in Khiva became apparent. After the seizure of power, the Bolsheviks began secretly preparing for the seizure of the Khiva khanate like the Bukhara emirate. The beginning of 1918 was difficult for the Khiva Khanate. Recognizing that the forces to fight against the increasingly growing political situation in power are insufficient, on January 22, 1918, Asfandiyorkhan proposed the joint administration of the khanate, the leader of the Javmut clan of the Turkmens, Zhunaidkhan, and invited him to the capital, Khiva. Asfandierkhan appointed Zhunaidkhan, who arrived in the capital, as army commander (Sardori Karim) and completely handed over all power to him[1,107]. However, after this, Asfandierkhan did not stay long on the throne.

Asfandierkhan, a weak-minded and life-burner, could not protect the country from the invasion of the Bolsheviks. On October 1, in his own

palace, he was killed by a group of malefactors led by his son Zhunaidkhan-Eshim. On the Khiva throne, Zhunaidkhan planted the elder brother of the murdered khan, Said Abdullahan[2,37]. The leader of the Young Khiva party, Polvonnies Khozhi Yusupov, subsequently wrote the following in his memoirs about this palace coup: "By their custom, the Yavmuts met with the Khan (Asfandiyorhan). It turns out they prepared a man to kill the khan.

When meeting with the khan, he stabbed the khan several times, pretending to want to say hello to him. After leaving the palace, the Turkmen killed the courtiers Ibrohim Hajj and Ruzimhammad with shots. Then, having called Yasaulbashi (the head of the Yesaul) to their private chambers, they took possession of all the Khan's jewelry: gold, diamonds, after that they announced the incident, and asked the citizens not to be afraid and not to worry about the incident. And the next day they proclaimed the khan the brother of the murdered khan, Said Abdullahan. After that, they buried Asfandierkhan in a madrassah built by the khan himself in an area called Obulwafoyi Khorazmiy[3,179]"



In a short time, Zhunaid Khan brought the number of his soldiers to ten thousand. But the military operations that took place in September 1918 and March 1919 showed that while the army of Junaid Khan was not ready in the fight against the Bolsheviks[4,47]. Junaid Khan retreated and agreed to begin peace negotiations with the Bolsheviks. However, his harsh demands that the RSFSR withdraw his troops from Khorezm and not interfere in internal affairs showed in practice that he would not be able to negotiate peacefully with the policy of the Bolsheviks[5,109].

On April 7, 1919, the Extraordinary and Plenipotentiary Representative of the RSFSR A.N. Khristoforov arrived at the residence of Zhunaid Khan in Takhta kala, located near Khiva for negotiations. On April 9, a peace treaty was signed between Soviet Turkestan and the Khiva Khanate in Takhta Kalye. During the negotiations, Zhunaidkhan sharply raised the question of the withdrawal of Russian troops from the territory of Khorezm. According to the agreement, the Soviet government recognized the right to choose its own path of the peoples of the Khanate, both sides committed themselves to ending any hostilities, arranging for the sending of representatives, guaranteeing the free and safe movement of the peoples of both countries on the territory of both countries - on land and waterways, establishing ties for the purposes of commerce on the territory of citizens of the other side. The agreement was soon approved by the Central Executive Committee of the Turkestan Autonomous Soviet Socialist Republic and the Khiva Khan Said Abullahan[7,55-56].

However, both sides, in particular, the Bolsheviks, did not comply with these requirements. As a result, in the summer of 1919, relations between Bolshevik Turkestan and the Khiva Khanate became even more tense. Zhunaid Khan made an external political alliance against Russia with the Emir of Bukhara, Said Olimkhan. The people who decided to protect their country from the Bolshevik invasion, first of all, defended their right to independence.

The leadership of Soviet Turkestan and its armed forces sought to seize the territory of the Khiva Khanate and the Bukhara Emirate, which are independent states, and create a revolutionary government in their place. This was a reflection of the new position of the Central Committee of the RKB (b) and the leadership of the RSFSR in relation to the Turkestan region. In the years 1918 - 1920 in the Khiva Khanate and the Bukhara Emirate, as well as the neighboring countries of Afghanistan, Iran, Turkey, India, China and other countries, huge national liberation movements and various uprisings took place. Among the top political leadership of the

Bolsheviks, opinions were strengthened about turning the liberation movements, which had intensified in the East to the interests of Soviet Russia, and not stop at the same time from using weapons and force to achieve imperial plans. So, as a result of the invasion of the Russian army in Iran in June 1920 and November 1921, the Republic of Gilon was created in the region of Gilon[8,560].

The first who tried on themselves the results of the military aggression of Soviet Russia was the Khiva Khanate. In the fall of 1919 turned up a good opportunity to organize an attack on this independent state. In September 1919, in his telegram to the Commander-in-Chief of the RSFSR troops, the Turkestan Revolutionary Council showed the following reasons for "substantiating" the military operations planned against the Khiva khanate: "... undoubtedly, as soon as the case presents itself, the Khiva khan will begin active operations ...[9,139]" The undeclared martial law between the Khiva Khanate and Bolshevik Turkestan greatly strained the Bolshevik government and its representatives in Turkestan, and they already intended to solve this problem by using force. In this matter, the point of view of some leaders led by Trotsky became more and more priority. They demanded the use of national liberation movements, intensifying in the East in the interests of the "world revolution", up to the use of military force on this path[10,111].

The Bolshevik leaders in Russia and Turkestan sought to rally and strengthen all opposition forces in the Khiva Khanate. In November 1919, an alliance was created between these forces. Representatives of the large tribes of Kushmamedkhan and Gulomalikhan, who were at war with Zhunaidkhan, became part of a revolutionary alliance created together with the Communists and the Young Khivaites. This center had the goal of starting a war to overthrow the khan and take power into his own hands. The Bolshevik army was called to help[11,299-300].

This was an event that the Turkestan Bolsheviks were looking forward to. Because, it was a good pretext and a big "justification", in order to send troops to the territory of a neighboring country "to help the rebellious people of Khiva and" at his request ". In this matter in 1919 they were fully supported by the Turkestan Commission (Turkcommission) under the All-Russian Central Executive Committee and the Council of People's Commissars of the RSFSR. On December 20, 1919, the representative of the RSFSR in the Khiva Khanate Georgy Borisovich Skalov (1896 - 1935) received the directive of the Turkestan commission on providing assistance to the "rebellious Khiva people". The adoption of this





directive and its practical implementation was a direct invasion of the Russian government into the internal affairs of a sovereign Khiva state. The Turkestan Commission, as the controller of the region of the government of the RSFSR, was the direct executor of this aggression. It was not difficult to guess that the Directive of the Turkestan Commission on the introduction of troops into the Khiva Khanate was the essence of the general task assigned to this commission by the government of the RSFSR and the Central Committee of the RCP (b). This directive clearly showed the true purpose of the activities of the Turkestan Commission, the colonial essence of the Bolshevik policy regarding the East. The goal of the Turkestan commission from making such a crucial decision was to liquidate the Khiva Khanate, to have a decisive influence in choosing the form of government acceptable to the Bolsheviks and the Soviet government in establishing the political system in Khorezm in the future. As the Soviet leadership openly indicated in one of the documents regarding this issue, the goal of the Soviet state supporting this uprising in the khanate was "to prevent the spark from arising and to give it the right direction[12,112]".

On December 22, 1919, according to the Directive of the Turkestan Commission, the representative of the Turkestan Commission and the Turkestan Front (Turkfront) G. Skalov and the commander of the Amu Darya group N. M. Sherbakov gave the order to enter the territory of the Khiva Khanate "to assist his rebellious people". Parts of the troops of the Amudarya (Khiva) group were divided into two detachments: the Northern detachment under the command of N.A.Shaidakov and the Southern detachment under the command of N.M.Sherbakov. December 23 began the invasion of Soviet troops on the territory of the Khanate. As part of the Southern Detachment, a volunteer detachment consisting of Khiva fugitives (Young Khiva, Communists, etc.) fought. Simultaneously with the movement of Soviet troops, rebel groups, consisting of the Turkmen and Uzbek populations, joined them. Soon, the total number of Khiva rebels reached up to 3,000 thousand people. Soviet troops crushed the resistance of the soldiers of Zhunaidkhan, along with rebel forces captured Old Urgench, Eminkala, Porsu, Ilyali, Tashauz. In the second half of January 1920, they dealt a crushing blow to the troops of Zhunaid Khan in the Gazavat region, and approached the capital of Khiva, on February 1, they occupied the city without a fight[13,305]. On February 2, Khiva Khan Said Abdullahan renounced the throne. In the territory captured by Soviet troops, there was a lot of arbitrariness and violence.

In the liquidation of the Khiva Khanate, a certain role was played by Young Khiva residents. Such management methods as the monarchy, autocracy, characteristic of the Middle Ages, had become obsolete by the beginning of the 20th century.

## REFERENCES

1. *New history of Uzbekistan. Book 2. Uzbekistan during the Soviet era. Scientific editor: M. Juraev. - Tashkent: "Sharq", 2000. - B. 117.*
2. *Rajabov K. Independent Movement and Junaidkhan in Khorezm // "Society and Management", 2000. № 1.*
3. *Polvonniyoz Hoji Yusupov. History of Young Khiva.*
4. *Rajabova R. Offish times.*
5. *History of Uzbekistan (1917-1991). Two books. The first book. 1917-1939.*
6. *The history of Khorezm from ancient times to the present day. - Tashkent: "Fan", 1976.*
7. *Muhammadberdiyev K.B. The history of the Khorezm revolution. - Tashkent: "Fan", 1986.*
8. *M. Persitz. Shy intervention. About the Soviet invasion of Iran and Bukhara in 1920 - 1921. 2-ed. - Moscow: "Ant-Hyde", 1999. - 200 s; Genis V. Red Persia. Bolsheviks in Gilan 1920 - 1921. Documentary chronicle. - Moscow: MNPI, 2000.*
9. *Foreign military intervention and civil war in Central Asia and Kazakhstan. Documents and materials. T.1. - Alma-Ata: "Science", 1963. - S. 139.*
10. *History of Uzbekistan (1917-1991). Two books. The first book. 1917-1939.*
11. *Turkestan at the beginning of the twentieth century: to the history of the origins of national independence. Scientific editor R.Ya. Rajapova. - Tashkent: "Sharq", 2000.*
12. *History of Uzbekistan (1917-1991). Two books. The first book. 1917-1939.*
13. *Turkestan at the beginning of the twentieth century: to the history of the origins of national independence.*





# **ORGANIZATIONAL STRUCTURE AND LEGAL BASIS OF RADIO BROADCASTING IN UZBEKISTAN (1927-1980)**

**Temirova Mashxura Muhammadaminovna**

*Teacher of Kokand State Pedagogical Institute Kokand, Uzbekistan*

## **ABSTRACT**

*The article deals with issues related to the organizational structure and legal framework of radio broadcasting in Uzbekistan, as well as the people who led the activities of the structure. It is also said that the decisions of the government and the center, which regulate the process of radio broadcasting and broadcasting in the country, have served as the basis for the activities of the industry.*

**INDEX TERMS:** *radio, radio station, radiofication process, hardware, material and technical base, programs, radio stations, radio committee, information, radio waves, radio points.*

## **LEVEL OF STUDY OF THE TOPIC**

Research on the emergence of radio in Uzbekistan and its activities serves as a methodological basis for this research. In this regard, philologists R. Abdusattorov, Nishonbaev have a special scientific significance [1]. Their research covers the journalism of Uzbek radio. The history of the formation of Uzbek radio up to 1937 was studied by B. Rihsiev [2]. A.F. Esin also studied radio and television from a historical point of view in his scientific work [3]. The brochures of S.E. Smirnov [4] and R. Rakhmonov [5] on radio activity also have a special place. Also, the history of Karakalpak radio in 1930-1990 was studied by T. Madraymov [6], the role of the media, in particular, radio in the development of cultural life of the republic in 1950-1990. Mavrulov and, studied by Yu. Ergasheva [7]. It is noteworthy that these studies cover different periods of the radio broadcasting process in the country and its activities.

The process of complete accomplishment of the radiofication process in Uzbekistan, its material and technical condition, the issue of radio journalists and the process of radio coverage of the population has not been systematically studied. Republican radio shows a lack of historical coverage, both in the Soviet era and in the years of independence. The Central State Archive of the Republic of Uzbekistan has a lot of information on the history of radio

broadcasting and the lack of a comprehensive analysis of scientific research on the history of national radio requires a scientific study of the subject.

## **THE MAIN PART**

During the years of Soviet rule, the centralized system of government, which dominated the processes of central and local political governance, influenced the management of radio affairs, among other areas. The leaders of the central government of the USSR also paid special attention to such issues as the organization of radio broadcasting in the republics of the Union, as well as the establishment of bodies that control these processes, the definition of goals and objectives of these organizations. In particular, on the basis of the decisions of the Council of People's Commissars of the USSR in the organization of the radio broadcasting process in the Republic of Uzbekistan, important instructions were given by the People's Commissars of the Uzbek SSR. In 1927, when permanent radio broadcasting was established in Uzbekistan, the Central Committee of the CPSU (b) headed the management of radio broadcasting and radio broadcasting. Since 1925, this organization has been working on the basis of the tasks carried out by the Commission for the Organization of Radio Propaganda under the Department of Propaganda (Agitation and



Propaganda - MT) of the Central Committee of the CPSU (b). At that time, the following issues were identified as priorities of the main processes:

- provision of transmitters and receivers with the necessary equipment to ensure the organization of large-scale advocacy and cultural and educational work;

- intensive radio broadcasting of villages;
- The main priority is to strengthen propaganda and cultural-educational broadcasts [8].

In the early years of Radio Uzbekistan, the heads of political, economic and cultural organizations and groups of organizations working in the government of the republic worked on the above-mentioned tasks. In particular, the Ministry of Communications of the USSR was responsible for radio broadcasting in the republics of the USSR, and was regularly involved in logistics and logistics for the organization of radio broadcasts. VA Mokhryakov, Head of the Central Asian Communications Department, provided the necessary technical and financial assistance for the organization of radio broadcasting and broadcasting in Uzbekistan [9].

In July 1928, the Council of Labor and Defense passed a resolution "On the reorganization of radio broadcasting", according to which the joint-stock company "Radio Broadcasting" was liquidated. The organization and management of radio broadcasting in the territory of the USSR was entrusted to the People's Commissariat of Posts and Telegraphs. A special radio administration was established within this People's Commissariat. On December 28, 1929, the Central Asian Communications Department decided to establish a Republican Radio Council under the Soviet of People's Commissars to manage radio broadcasting in the USSR. The Radio Soviet is the only body of radio broadcasting, managed by the Soviet Central Radio Soviet. The tasks of the Council of People's Commissars of the USSR were:

- Management of radio broadcasting and broadcasting in the territory of the USSR;

- Review of radio broadcasting plans and monitoring of their implementation, ie control (censorship) of radio broadcasts;

- Viewing broadcasting plans, contracting with organizations interested in radio, sponsoring their services in the implementation of this work;

- Review financial plans and find the necessary funds for their material and technical support;

- Preparation of programs on political interests, education with the permission of the top, the development of radio programs to attract public attention to strengthen the propaganda;

- Conducting events to increase the number of radio listeners, organizing conferences and providing insights on compliance with established rules;

- Planning general public works around the radio and linking existing processes with the activities of the organization [10].

In 1931, the All-Union Broadcasting Committee under the People's Commissariat, and in 1932, in connection with the reorganization of the People's Commissariat of Posts and Telegraphs, the People's Commissariat of Communications of the USSR became known as the All-Union Broadcasting Committee. In 1933, a governing body called the All-Union Committee on Radio and Broadcasting was established under the USSR Council of People's Commissars. [11]

In 1930, the organization and management of radio broadcasting in the USSR was transferred to the People's Commissariat of Post and Telegraph. A special radio station was established within the People's Commissariat, and in 1931 the All-Union Broadcasting Committee under the People's Commissariat and in 1932 the People's Commissariat of Communications of the USSR became known as the All-Union Broadcasting Committee [12].

The scale of radio broadcasting in Uzbekistan has expanded. One of the most important events in the field of radio work in the country was the opening of the radio center in Tashkent, which was established in September 1929 and played an important role in the development of radio broadcasting in the country. Taking into account the influence of radio broadcasting on the broadest strata of the republic, in December 1931 the Central Asian Broadcasting Committee was established in Tashkent, which was later renamed the Uzbek State Radio Committee [13].

Based on the transformation of the USSR Council of People's Commissars into the USSR Council of Ministers in March 1946, the All-Union Radio Committee under the USSR Council of People's Commissars was renamed the All-Union Radio Committee under the USSR Council of Ministers [14].

In July 1949, the USSR Council of Ministers renamed the All-Union Committee on Radio and Broadcasting under the USSR Council of People's Commissars into the Committee on Radio Broadcasting (internal broadcasting) and the Committee on Radio Broadcasting under the USSR Council of Ministers (for foreign listeners) [15].

Despite the fact that the radio organizations of the republic changed several times since the establishment of radio in the republic until the end of 1950, the republican radio was organized on the basis of the charter established by the Central Radio Council. Regardless of which of the above organizations was under the control of the Republican Radio, the radio operated on the basis of its own directions of becoming the main propagandist of the communist ideology.



In 1957, Uzteleradio was established in the republic. In mid-1958, by a government decision, the Radio House was transferred from the Ministry of Communications to the Committee on Television and Radio Broadcasting [16].

In 1952-1957, the Radio Committee of the USSR was under the General Directorate of Radio Information of the Ministry of Culture of Uzbekistan. During these years, the program of the only television studio "Tashkent" was broadcast via an antenna mounted on a 180-meter TV tower and a transmitter TTR-5/2: 5 kW [17].

The activity of the People's Commissars of the Uzbek SSR played an important role in the systematic organization of the activities of the Radio Committee of Uzbekistan. Chairman of the People's Commissars of the USSR (1925-1937) Fayzulla Khodjaev played an important role in the establishment of the Republican Radio. Fayzulla Khodjaev regularly supervised the construction of the first radio station in Central Asia, the Tashkent Radio Station, in 1926, and the 25-kilowatt Tashkent Radio Station in 1929. [18] Also, the activities of the heads of the committees on the instructions of the Council of People's Commissars played an important role in the organization of radio broadcasting and broadcasting in the country.

The first director of the Tashkent radio station was E. Koksharov (1927-1930). E. Koksharov was directly involved in the construction of the Tashkent radio station, the installation of the radio station and the initial equipment of the building allocated for radio broadcasting, as well as the organization of the work process. E. Koksharov also informed the chairman of the Council of People's Commissars F. Khodjaev that in 1928 the radio station was in a difficult financial situation and developed measures to overcome this situation. The Council of People's Commissars will study the situation and take measures to eliminate the existing problem [19]. Abdullaev, Ankaboy, Ziya Said, and Rakhmonov, who served as chairman of the Republican Radio Committee after 1930, were instrumental. During their leadership, the process of radio broadcasting in the country was completed, the Tashkent Radio House was built and re-equipped. The type and size of broadcasts increased. Republican radio has served to ensure that it is always at the forefront among the allied republics.

Along with the organizational aspects of radio work and radio broadcasting processes in Uzbekistan, its legal aspects have also been created. On February 8, 1927, in accordance with the order of the Council of People's Commissars on radio broadcasting of provincial, city, district centers and collective farms in the republic [21], radio broadcasting of the republic was intensified.

The Republican Communist Party was involved in organizing propaganda and propaganda

issues on the Republican Radio. The decisions and instructions of the Communist Party of the USSR served as the legal basis for the party's dissemination of propaganda work.

The management of the Central Committee of the Communist Party for Broadcasting and Broadcasting provided party leadership over these broadcasts. The above-mentioned examples, set as the main task by the Commission, have served as an important program in the organization and implementation of the radio broadcasting process in all the republics of the Union, as well as in Uzbekistan. In this regard, the party has served as an important tool in communicating all the reforms, decisions and tasks in the social, political, economic and cultural spheres of the republic. During the leadership of the Central Committee of the Communist Party on radio broadcasting, decisions were made on the initial stage of radio broadcasting in the country, and a lot of work was done on its implementation.

Since the late 1920s, the Central Government of the USSR has issued many decisions and instructions on the process of radio broadcasting in the republics of its union. Such decisions issued by the central government served as a legal basis for the development of radio broadcasting and broadcasting, as well as for the development of broadcasting activities in the republics. In particular, in Uzbekistan, a number of resolutions and orders issued by the USSR and the government of the USSR aimed at the development of broadcasting and radio broadcasting served as the organizational and legal basis for the activities of the republican radio.

The construction of the first radio station in the country had a specific legal basis for the beginning of radio broadcasting in other regions of the country. It is known that in the late 1920s and 1930s, attention was paid to the subordination of all spheres of life in the republic to the ideology of the Soviet regime. The development of all social, economic, political and cultural spheres of society played an important role in the conduct of the population's attitude to labor in accordance with Soviet society. For this reason, in the late 1920s and 1930s, a number of decisions were made in the republic to improve radio broadcasting in the republic and to expand the process of radio broadcasting. These decisions have led to the further popularization of radio in the development of industry and agriculture in the country, educating the population in accordance with the party's ideas. In particular, in 1928, the Council of People's Commissars of the USSR "On the next tasks in the field of radio broadcasting." The resolution not only identified important tasks related to radio broadcasting in the country, but also indicated ways to improve radio propaganda, radio broadcasting in general [23]. Also, the decision of the XV Congress



of the Council of People's Commissars of the USSR in 1928 to pay special attention to the cultural sphere showed the importance and urgency of the work of radio broadcasting in the republic. It was noted at the meeting that the process of radio broadcasting in the country should be included in the list of cultural events, as the existing radio stations in the country are showing their results, despite the short time. Following this decision of the Council of People's Commissars, large-scale urban and rural radio broadcasting began in Uzbekistan [24].

The decisions of the Presidium of the State Planning Commission of August 29, 1929, approved by the Council of People's Commissars of the Uzbek SSR on July 29, 1929 also played an important role in the successful implementation of radio broadcasting in Uzbekistan [25]. On September 18, 1929, a conference of the Society of Radio Friends was held in Andijan to expedite radio broadcasting in cities and villages. An appropriate decision was made on the issues discussed at the conference, and on the basis of these decisions, radio broadcasting was soon revived.

Shortly afterwards, on October 16, 1929, the first congress of the Society of Radio Friends of Uzbekistan was held. The congress highlighted the important role of radio in promoting the reconstruction and consolidation of agriculture in the country, the development of heavy industry, the promotion of urban and rural culture. It was noted that the development of radio broadcasting in the country is one of the important tasks in the implementation of the above-mentioned state programs, given that a large part of the population is illiterate. The congress identified the work of the Society of Radio Friends on the basis of specific plans for the future of radio broadcasting and broadcasting. In particular, it set itself the task of organizing radio clubs, organizing special radio posts, training staff for radio, and publishing radio-related literature [26]. In carrying out such tasks, the Republican Radio Council relied on the decisions and instructions of the Central Radio Council with the support of the Council of People's Commissars of the USSR.

The above tasks were organized on the basis of the 1929 Statute of the Radio Council. This regulation consisted of 4 sections and 10 clauses, almost identical to the central radio Soviet regulations. The activity of the radio center was carried out on the basis of this Charter. The regulations are divided into separate sections according to the content of the preparation of broadcasts in the radio center. In particular, it consisted of the Department of Artistic and Dramatic Broadcasting, the Department of Political Broadcasting, and the Department of Educational and Musical Broadcasting [27].

The decision of the Council of People's Commissars of 27 January 1931 [28] proclaimed the right of all citizens, organizations and enterprises to install and use radio equipment in their workplaces or in their homes. This decision served to further liberalize the activities of radio organizations in this area.

In 1933, the Council of People's Commissars of the USSR approved the "Charter of the All-Union Committee on Radio and Broadcasting under the Council of People's Commissars of the USSR [29]". Radio, Central Broadcasting, and Local Broadcasting Departments were established under the auspices of the Committee. In particular, the regional radios, which began their work on the basis of the Tashkent radio station, have now received the status of the regional radio committee. The regional radio committees are subordinated to the republican radio committee and operate independently on the basis of the established charter.

The 1934 meeting of the Central Asian Economic Council on "Radio Broadcasting and its Development" was important for the development of national radio. The Council considers that it is necessary to further expand and improve the work of radio in the country, taking into account the effective contribution of national radio in the achievements of agriculture, industry and other economic growth processes of the republic. The meeting highlighted the achievements in the field of broadcasting and radio broadcasting, as well as listed the existing shortcomings and gave specific instructions to address them. The Ministry of Communications, as the main organization responsible for the implementation of tasks in this area, is entrusted with the control of [30]. The implementation of the issues raised at this meeting will show its positive results. By 1935, the total number of radio stations in the country was 7,297 [31]. This is three times more than in 1930. [32]

On February 2, 1935, Fayzulla Khodjaev, the chairman of the HKS, in his speech at the council of radio workers, spoke about the achievements and shortcomings of the republican radio. In addition, his instructions on the organization of future programs of the national radio, strengthening its material and technical base, as well as training of radio technicians and journalists, training of radio specialists served as the legal basis for the development of national radio [33].

The decision of the All-Union Radio Broadcasting Committee under the USSR Council of People's Commissars on November 11, 1935 "On the improvement of radio broadcasting in the national republics and regions" played an important role in the development of republican and regional radio. This decision covered all the processes related to radio broadcasting and broadcasting in terms of content. In particular, along with the development of national





radio, the tasks were set to organize the work of regional radios, to send special instructors to remote rural areas, as well as to control the regular operation of radio stations in all collective and state farms [34]. As a result of this decision, the Tashkent Directorate of Radio Communication and Broadcasting was established in 1940 on the basis of the first high-capacity radio station, which was transformed on March 27, 1941 into the Directorate of Radio and Broadcasting of Uzbekistan. As a result of the work carried out in the radio administration of the republic, by 1941, the first stage of radio broadcasting in Uzbekistan was completed. That is, at this stage, the centers of all regions of the country were radioed as a result of the analysis conducted by the Republican Radio Council.

The outbreak of World War II required the military deregulation of all sectors of the republic. One of the most difficult and responsible tasks here was to further develop the newly recovering economy and to supply all the necessary material goods for the front. It was also an important issue of these years to double labor productivity in agriculture. In addition, public awareness campaigns to ensure mass mobilization on the front have become a topical issue. Further improvement of the republican radio played an important role in the positive, rapid and effective solution of all measures in this direction. The need to broadcast the calls and messages to the public served as an important factor for the organizational legal framework of the radio's activities in these years and in the post-war years. Taking into account the policy of the Soviet government in the late 1920s and 1930s, May 6, 1945 was designated as Radio Day by the decision of the People's Commissars of the USSR, taking into account the effective work of radio during World War II. Since then, it has become a tradition to celebrate May 7 every year as "Radio Day". This, in turn, played an important role in the organizational work of the republican radio. In particular, Uzbekistan, like all the republics of the USSR, has been preparing for this day, and various competitions and festivals have been held between the republics. Such events have created a great basis for the improvement of the republican radio in all respects.

In the post-war years, Uzbekistan began to implement the five-year plans of the Communist Party, based on the unlimited use of cheap energy and rich resources of its people. Such qualities as diligence, patience and peace-lovingness of the Uzbek people were used in carrying out the task of unilaterally bringing the economy of the Republic to the pre-war level and further development, subordinated to the interests of the Center. The results of the Second World War once again showed that the use of radio's extensive capabilities in the implementation of the plans set by the Soviet government would be effective. For this reason, he

focused on the development of radio, which is an active promoter of five-year, seven-year and nine-year plans focused on various issues. Every decision and instruction on the successful completion of the above-mentioned plans has served as an impetus for the development of national and regional radio.

The most important tasks for the economy were outlined in the plan for 1946-1950, adopted at the 8th session of the Supreme Soviet of the Uzbek SSR in August 1946. The development of industry is focused on the development of cotton growing, which is a leading sector of the economy. The Resolution of the Soviet Government of February 2, 1946 on measures to restore and further develop cotton growing in Uzbekistan became the basis for strengthening cotton monopoly in Uzbekistan [36].

Naturally, such a topical issue has placed a great responsibility on the Republican Radio, which since its inception has extensively covered agriculture in its programs. For this reason, on June 29, 1945, the Chairman of the Council of People's Commissars of the USSR A. Abdurahmanov and the Secretary of the Central Committee of the Communist Party of the Soviet Union U. Yusupov adopted a Resolution "On Improving Broadcasting and Broadcasting in the Republic." The resolution considers the implementation of radio work to be very low, gives instructions on specific items to improve it and attaches it to the responsible persons [37].

In the 1950s, a number of decisions were made to develop radio broadcasting and broadcasting in the republic. The practical results of these decisions have played an important role in the development of the material and technical base of national and regional radios, as well as in increasing the number of radio stations in the regions.

Numerous decisions to increase the range of broadcasts aimed at those working on the Soviet government's agricultural development programs have served to improve the work of groups that make up radio programs, but in fact have extinguished the morale of the people and put the economy first. In particular, in April 1951, a meeting of the Bureau of the Communist Party of Uzbekistan discussed the issue "On the state of the art of music and measures to further improve it." It was noted at the meeting that the Department of Arts has been doing harmful work for many years, creating dramatic performances of opera, ballet and music with such legendary content as "Farhod and Shirin", "Layli and Majnun", "Tahir and Zuhra". The resolution recommended revising genre repertoires and radio broadcasts [38]. This decision of the Republican Communist Party served as a legal basis for the development of radio programs.

In the 60s of the XX century, in order to further develop cotton growing, the Government of the Republic paid great attention to the development





of Mirzachul. During these years, measures were taken to develop the reserve and gray lands and on this basis to increase the cultivation of cotton and grain [39]. It is more accurate to say that the beginning of this new process of mastering Mirzachul in the republic has now clearly defined the tasks of the radio. Satisfaction with the achievements of young people working in the development of the Surkhan-Sherabad desert was expressed in letters to the radio newspaper "Struggle for Cotton", which was broadcast on the radio [40]. The measures taken by the Soviet government to implement this policy in a timely manner, of course, required the intensification of propaganda work among the people. For this reason, the country has developed decisions to increase the role of the media in society. In particular, the resolution of the Central Committee of the CPSU of January 4, 1960 "On the tasks of party propaganda in modern conditions" emphasizes the important role of radio in the promotion of party ideas [41]. The implementation of these tasks has had a positive impact on the formation and improvement of the legal framework of the national radio.

The decision of the Central Committee of the CPSU on June 29, 1960 "On the further development of public initiatives in the Soviet press and radio" accelerated the activities of the republican radio [42]. The process of analysis of the activities of the Republican Radio shows that as a practical result of this decision, attention was paid to the fact that after the 60s, radio programs were organized according to the wishes of listeners. The letters sent by the listeners to their radio stations were studied and sent to them not only by radio but also by mail to the indicated addresses.

In accordance with the Resolution of the Central Committee of the Communist Party of Uzbekistan and the Council of Ministers of the Uzbek SSR of September 26, 1961 "On measures to accelerate the completion of mass radio broadcasting in the Uzbek SSR and the development of broadcasting and television in the republic" instructions were given to provide each family with a radio reception point [43]. As a result of the measures taken in the country on this decision, by 1970 the number of radio stations increased by 8% compared to 1930, the number of radio organizations by 4.9%, and the number of radio stations by 50%. In the 1970s, radios entered all homes and worked continuously. The decision became the basis not only for the completion of the radio broadcasting process, but also for the strengthening of its material and technical base, the systematization of specialists and their work process. On May 27, 1971, the USSR Council of Ministers adopted a resolution on the "Charter of Communications of the USSR." Paragraph 2 of the first part of the Resolution, entitled "General Rules", stipulates that the organization and design of radio broadcasting and

broadcasting shall be carried out in accordance with this Regulation, while Paragraph 3 of the Regulation states that "public radio broadcasting and radio broadcasting within the Ministries of Communications of the Allied Republics" [44]. Due to the great political importance of radio broadcasting for the state and society, Article 21 of the Regulation stipulates that any buildings and structures under construction must agree with the Ministry of Communications so as not to interfere with radio broadcasting, regardless of the relevant ministries [45]. Paragraphs 76-78 of the Regulation define the technical issues of the organization of radio broadcasts. Article 85 of the Regulation stipulates that the organization of any type of radio broadcasting shall be organized by organizations designated by the Ministry of Communications, if the enterprises and organizations have internal radio broadcasts, in strict compliance with the relevant rules and technical norms [46]. This regulation, developed by the Center, has served as a basic guide for professionals working in the field of national radio. On the basis of the charter developed by the Center, the Ministry of Communications of the USSR gave instructions to all radio committee organizations in the republic on the organization of radio broadcasting in the republic and monitored the actual results of the work performed on the basis of this charter.

In general, the regulations and decisions developed by the government of the USSR for the development of the radio industry in all republics also served as an impetus for the development of radio in Uzbekistan. As a result of the work carried out in the country on these decisions, in the 70-80s, the Uzbek radio served as a legal basis for its comprehensive development compared to the past.

Although the emergence and development of radio in Uzbekistan was a historical necessity, it was actually a technical development that had to happen. In the 1920s, when radio began to enter Uzbekistan, its potential was widely used in many countries, including Europe. For this reason, the leaders of the Soviet government paid special attention to the radio broadcasting of the republics. The figures given in the section above show that radio is widely developed in Uzbekistan, albeit slowly. The reason is that the first radio station in Central Asia was built in Tashkent. It was this first two-kilowatt radio station that in 1941 served as an impetus for the penetration of radio into many regions and remote areas of Uzbekistan.

The activities of the Radio Committee of Uzbekistan, the systematic and beneficial organization of its work were based on the regulations and decisions issued by the center. As a result of the implementation of these decisions and regulations, the Republican Radio has been able to meet its needs in all respects. The decisions made by



the Center are based on the ongoing political, economic, socio-spiritual processes in the country and the need to communicate them to the public, which, of course, has led to a strong base in all areas of radio. From this point of view, every historical process in the republic, the efforts to implement them have served to improve the legal framework of the republican radio. On the other hand, it was the desire of the USSR to evaluate its policy correctly for the states of the outside world. This was because the policy of the USSR government towards the states of the union was openly criticized by the countries with developed radio industry. For this reason, he focused on expressing on the radio that the peoples of the union were satisfied with their lives. This situation also served as one of the legal bases for the expansion of the radio broadcasting process in the country. As a result of internal and external factors, radio has been formed and developed in Uzbekistan for almost 50 years.

### TRANSLITERATION

1. R.Abdusattorov. *Information broadcasts of Uzbek radio: problems and solutions, journalistic skills (1989-1994) ref. diss Phd philology.*- T., 1996.
2. Rikhsiev B.A. *Formation and development of the Uzbek broadcasting (1917-1937). Author's abstract. Diss. Historical sciences.*- T., 1972.
3. Yesin A.F. *The activities of the Communist Party of Uzbekistan to increase the role of broadcasting and television in the communist education of workers (based on the materials of broadcasting and television in Uzbekistan, 1959 - 1966 g): Author / diss. Candidate of historical sciences.*- T., 1977.
4. Rakhmonov. R. *National audience of Uzbekistan – T. : Uzbekistan, 1977.*
5. S.E. Smirnov. *Says Tashkent –M-T.: Ogiz 1932.*
6. Madreimov T. *History and development of mass media in Karakalpakstan in 1930-1990. (radio broadcasting and television). Author's abstract. diss ... cand. Historical science.*- T., 1997.
7. Kravchenko E.V. *The history of regional broadcasting (on the example of the Krasnodar Territory). Abstract of dissertation for the degree of candidate of philological sciences.* –Krasnodar. 2007. Page 10
8. *Central Archive of Uzbekistan, R.86 fund, 10 lists, 84 volumes, 73 pages.*
9. *Central Archive of Uzbekistan, Fund R.736, List 1, Collection 838, 21 pages*
10. Yesin A.F. *The activities of the Communist Party of Uzbekistan to enhance the role of broadcasting and television in the communist education of workers (based on broadcasting and television of Uzbekistan, 1959-1966): Abstract. diss. Cand. East. Sciences.*- T., 1977. -- P.6.
11. Temirova M, Imomnazarova Yu. *Radio in Uzbekistan during the years of independence: directions of development and transformation.* - T; 2017. –B. 8.
12. Yusupov I. *Introduction of radio communication in Uzbekistan and the history of its development (on the example of Khorezm) // Education and upbringing.* - 2018. №3 (18) June. - p.19
13. Kravchenko E.V. *The history of regional broadcasting (on the example of the Krasnodar Territory). Abstract of dissertation for the degree of candidate of philological sciences.* - Krasnodar, 2007. -- P.11.
14. Kravchenko E.V. *The history of regional broadcasting (on the example of the Krasnodar Territory). Abstract of dissertation for the degree of candidate of philological sciences.* Krasnodar - 2007. - Page 11
15. Maxammetov M, Atamuratova Sh. *Television and radio directing.* –T. : Niso polygraph, 2017 –B.11.
16. Yusupov I. *Introduction of radio communication in Uzbekistan and the history of its development (on the example of Khorezm). Special issue Published in Education and upbringing №3 (18) June 2018 z.*
17. Rixsiev B. *The formation and development of radio in Uzbekistan. (1917-1937) Thesis for the degree of candidate of historical sciences.* –T, 1972. -B.6.
18. *Central Archive of Uzbekistan, R. Fund 1822, List 1, Volume 111, Page 48*
19. Rikhsiev B. *Formation and development of Uzbek broadcasting. Theses for the degree of candidate of historical sciences.* - T, 1972. - 220 p.
20. Khusainova M. *Namangan radio // Correspondent.* - T, 1973. - №7. - B.46.
21. Rixsiev B. *On the wing of the waves.* - T. : Uzbekistan.1967-B.6.
22. *Central Archive of Uzbekistan, Fund R.837, List 2, Volume 407, Page 17*
23. *Central Archive of Uzbekistan, Fund R.837, List 5, Collection 387, Page 32*
24. *Central Archive of Uzbekistan, Fund R.246, List 1, R. Volume 1053, page 103.*
25. Khusainova M. *Namangan radio // Correspondent.* - Tashkent, 1973. - №7. - B.46.
26. *Central Archive of Uzbekistan, Fund R.296, List 1, Volume 142, Page 21*
27. *Pravda vostoka, 1931, June 23.*



28. Kravchenko E.V. *The history of regional broadcasting (on the example of the Krasnodar Territory). Abstract of dissertation for the degree of candidate of philological sciences. Krasnodar - 2007. Page 11*
29. CAU, fund R.9, list 1, collection 763, page 155
30. CAU, Fund R.1619, List 11, Volume 215, Pages 3-4
31. Rikhsiev B. *Formation and development of Uzbek broadcasting. Theses for the degree of candidate of historical sciences. - Tashkent, 1972. - 114 p*
32. Xujaev F. *Let's rebuild the radio front. Selected works. Volume III. - Toshkent: Fan, 1980. - B. 321.*
33. Muhamedov.Yu. *Development of connection in Uzbekistan.- Toshkent, 1966. - P.19-20.*
34. Rixsiev.B. *On the wings of waves - T. : Uzbekistan. 1967. - B .39.*
35. *History of Uzbekistan. Volume II // T. :, 2015. - B .295.*
36. CAU, Fund R.2356, List 1, Volume 101, Page 16
37. *History of Uzbekistan Volume II // T. :, 2015. - P .334.*
38. *History of Uzbekistan Volume II // T. :, 2015. - P .334.*
39. Hidayatov.S. *Radio Uzbekistan is fighting for cotton. -T. : Uzbekistan. 1972. - p .3-4.*
40. *Red Uzbekistan // January 12, 1960 issue.*
41. Rixsiev.B. *On the wings of waves. - T. : Uzbekistan. 1967. - B .39.*
42. CAU, Fund R.837, List 39, Collection 656, Page 147.
43. *Decree of the Council of Ministers of the USSR "On the Approval of the Charter of Communication of the USSR" dated May 27, 1971 N 316.*
44. *Decree of the Council of Ministers of the USSR "On the Approval of the Charter of Communications of the USSR" dated May 27, 1971 N 316 ..*



## NARRATIVE THEORY-TEXT AS AN OBJECT OF RESEARCH IN NARRATOLOGY

**Hamroyeva Farida Fakhriddinovna**  
*Teacher of Samarkand State Institute of Foreign Languages*

### ANNOTATION

*Modern narratology as a science has become a separate research center at a turning point.*

*Narratology is the most effective direction for the complex analysis of a literary text. Narratology is developing in two directions: literary and linguistic. This is important for the cognitive analysis of a literary text. The text is a structure compiled by a historical author. The problem of literary text fragmentation is the result of the author's conscious and premeditated goal.*

*The terms that lead to an understanding of the supposedly theoretical basis of the narrative are defined in the text description plan. ( focalization, discourse, montage)*

*Literary criticism today studies literary and artistic works not only in relation to the author, but also in relation to the perceptual consciousness of the reader.*

*In addition to this research in the field of "storytelling techniques", narratology attaches great importance to the "consciousness" of the character.*

**KEYWORDS:** *Narratology, narrative theory, cognitive approach, artistic discourse, narrative structure, cognitive theory, narrative science, literary narrative, philology, linguistics, narratologist.*

### DISCUSSION

In modern philology there is a large amount of scientific work devoted to the study of the peculiarities of the writer's narrative thinking from the point of view of the cognitive approach. The base of narratology is one of the most promising branches of philological science, which is Russian structuralism, and today is the focus of philologists in various fields. The issues mentioned above have been studied in the following works: N.I. Matveeva "Narrative structure of artistic discourse in English": in the materials of the novel "stream of consciousness" in the early 20<sup>th</sup> century (2003); G.A. Borse "William Faulkner and the oral text" (2004) and his book "Narrative Technique: It's Theory in Fiction", Ryan.M.L "Narrative Entry for the forthcoming Routledge Encyclopedia of Narrative" (2004). A. Palmer created two books that served as the basis for narrative science: "Fictional minds" (2004) and "Social minds in the Novel" (2010). We would also like to highlight the

dissertations written in recent years: Andreeva K.A "Literary narrative: text semantics, cognitive aspects of poetics" (2004), Krasnoperova I.A "Cognitive-linguistic analysis of stable narrative structure" (2008), Kovalev O.V "Narrative Strategies in Literature" (2009).

W. Schmidt writes in his article "Prospects and Frontiers of Cognitive Narratology": "Cognitive Narratology, which is extremely colorful, opens up new horizons for literature.... Its main function is the analysis of the relationship between both narrative and the consciousness of the characters being portrayed, as well as the perceptual mind of the reader" [1]. In this article, among the current western narratologists A. Palmer's authoritative opinion and the debate over the effectiveness of fictional imagery are as follows: "This problem was not posed by anyone but by A. Palmer himself" (2004; 2010; 2011). Palmer accuses "classical" narratology of concentrating a one-sided, introspective view of closed, private, "intramental" consciousness. It requires from narratology an external perspective that



studies phenomena that it calls social mind and intermental thought: “which is joint, group, shared, or collective thought, as opposed to intramental, or private, individual thought” [2].

It should be noted that most researches relied on W.Schmidt’s work while acknowledging the importance of his “Narratology” in any case, while editing and debating some of the cases. In his study “ Analysis of Narrative Discourse” A.I.Tyupa writes: “Modern narratology is a very broad field of scientific research in the field of plot-narrative ideas (discourse) interrelated with any fable ( event, intrigue). The role of the philosopher Paul Ricker, the historian Hayden White, and the literary critic Wolf Schmidt, who have made significant contributions to the current state and direction of narratological research, is particularly noteworthy” [3]. If we evaluate the books of W.Schmidt in terms of the level of information, its level is extremely wide. The researcher is not limited to the history of narratology, but emphasizes the practical value of narratology, quoting writers who emphasize the core of science based on the “specificity of functional narrative” [4]: “...people in a novel can be understood completely ... .And this is why they often seem more definite than characters in history, or even our own friends; we have been told all about them that can be told; even if they are imperfect or unreal they do not contain any secrets, whereas our friends do and must, mutual secrecy being one of the conditions of life upon this globe..... But in the novel we can know people perfectly, and, apart from the general pleasure of reading, we can find here a compensation for their dimness in life. In this direction fiction is truer than history, because it goes beyond the evidence.... ”[5].

W.Schmidt’s research presented a generative model of the creation of a narrative device, the occurrence of which can also be traced in the novels of Scott Fitzgerald. According to the W.Schmidt “the task of generating models is to differentiate narrative operations, which transform the original material embodied in a work of art into a possible final product, the narrative text, as well as to create a logical sequence of operations will be in charge” [6]. Today, narratology, as W.Schmidt points out, is based on M.M.Bakhtin, V.B.Shklovsky, Yu.Timyanov is one the most promising branches of philological science, which later formed the works of Russian structuralists, such as representatives of the Tartu School (Yu.M.Lotman). Analyzing some of the ideas of B.M.Eichenbaum and V.B.Shklovsky, W.Schmidt rightly emphasizes the theoretical discoveries of his predecessors in the field of “ storytelling theory” concepts.

Narratology developed in two directions: literary and linguistic. L.V.Vitkovskaya says:

“Narratology, which at the present stage can be considered as a modern and more transformed form of structuralism, is, according to I.Ilin , a literary science that occupies a frontier between the phenomenological schools of structuralism and criticism” [7]. V.I.Tyupa emphasizes the importance of cognitive study of the text from the point of view of narratology, emphasizing its interdisciplinary nature: However , when neither the literary plot nor the theory of the literary narrator became part of narratology, it did not lose its originality and relevance. On the contrary, the rich literary experience in the study of genres, plot narrative poetics opens up new heuristic possibilities for their researchers and for modern rhetoric in general, while focusing on non-fiction narrative texts ” [8].

K.A.Andreeva in the article “ Marginal forms of the structure of modern narrative structure and semantics” provides important information about the importance of such a field of science: “ In connection with the appearance in the United Kingdom in 1988 of a special “ Dictionary of Narratology” by Gerald Prince, we consider it appropriate to take as a basis, citing the narrative definition given in it: “ Narrative is the transmission of one or more real or fabricated events ( as completion and process, object and act, structure and structuring) told by one, two or more narrators to one, two or more addressees” [9]. For us, the main keywords in this definition are obvious: structure and narrator. It should be noted that G.K.Kosikov’s article “Narrative” was published in “ Modern Western Philosophy. Encyclopedic Dictionary”. When we refer to it, we separate the necessary information as an “approach” to the text of the work of art: Narrative – story, short story. Narrative theory studies the construction of plot events ( French; histoire, reicit, intrigue; Germ; geschichte) and the general rules of plot structure.

“Narrative theory distinguishes three main levels of analysis from an epistemological point of view 1) activity 2) event and 3) original plot levels. The theory of activity describes a semantic axial grid that requires five minimum conditions that serve as the basis for narrative formation: Self- sufficient 5) The means used are known 4) On the way to achieve the goal this or that 3) Line- a specific of the action 2) The agent who is experiencing or performing the action in the situation 1) Agent. In the theory of narratology an action that violates a certain norm ( and therefore the expectations of readers or characters) and thus changes the current situation is an event” [10]. We emphasize the important ones: situations – activities (actions) within the plot are tools. It is this literary text, in our case, the criteria for the cognitive analysis of S.Fitzgerald’s novel.





Pragmatic research in linguistics has identified a number of specific features of narrative as a linguistic phenomenon, which have made it possible to carry out narrative analysis in accordance with its specific criteria and affiliations. T.Todorov shows the peculiarities of narrative: narrative logic, the sequence of events, the means of targeting in time and space, the author's explicit or implicit participation. It should be noted that in 2009 the Handbook of Narratology was published ("Handbook of Narratology. Ed.by Peter Huhn, John Pier, Wolf Schmid- Berlin; New York:Walter de Gruyter, 2009"). G.A.Lobanova's review of this publication states:.... "dictionary articles contain a number of paragraphs devoted to various problematic aspects.In addition, at the end of each article, in the opinion of the authors, the aspects of the events under study need to be studied first".

#### LIST OF USED LITERATURE

1. В.Шмид. *Перспективы и границы когнитивной нарратологии.* Гамбург, Германия. 2000. 6 ст
2. В.Шмид. *Нарратология – М.: Славянские языки.* 2003. 7 ст
3. Тюпа В.И. *Нарратология как аналитика повествовательного дискурса.- Тверь, 2001. 279 ст.*
4. Forster E.M. *Aspects of the Novel.* London, 1927. р 46, 47, 61.
5. В.Шмид. *Нарратология Пушкина.Пушкинская конференция в Стенфорде.* 2001. 14 ст
6. В.Шмид. *Нарратология – М.: Славянские языки.* 2003. 145 ст
7. Витковская. Л.В. *Когниция смыслаю Изд-во Пятигорского государственного университета.Пятигорск. 2012. 23ст*
8. Тюпа В.И. *Очерк современной нарратологии // Критика и семиотика. Вып. 5. Российский гос. Гумм. Ун-т. М., 2002.-Ст. 5-31.*
9. Андреева В.А. *Литературный нарратив: дискурс и текст* Спб.: Норма, 2006. 118 ст
10. Косиков Г.К. *Нарратив // Современная западная философия. Энциклопедический словарь. – М.: Культурная революция, 2009. – С. 159-160.*



# THE IMPRESSION OF CORPORATE SOCIAL RESPONSIBILITY (CSR) ON CORPORATE FINANCIAL PERFORMANCE (CFP) AND THE CONCEPT AND ROLE OF AGENCY THEORY

**Faria Rahman**

*Department of Law, School of Law, Galgotias University, India*

**Payal Pandey**

*Department of law, School of Law, Galgotias University, India*

## ABSTRACT

*The primary goal of an organization/company need to maximise its owners' value, but a proprietor's goal could be quite different. Consider Larry Jackson, 'The proprietor of a neighbourhood sports equipment stock. Jackson is in business to generate money, but he likes to require time without work to play golf on Fridays'. He also incorporates a rare employee who aren't any longer very productive, but he keeps them on the payroll out of friendship and loyalty. Jackson is running the business in a very way that's in step with his own personal goals. He knows that he could make more cash if he didn't play golf or if he replaced a number of his employees. But he's comfortable along with his choices; and since it's his business, he's liberal to make those choices. In contrast, Linda Smith is CEO of an oversized corporation. Smith manages the company; but most of the stock is owned by shareholders who purchased it because they were searching for an investment that might help them retire, send their children to varsity, acquire a long-anticipated trip, so forth. The shareholders elected a board of directors, which then selected Smith to run the corporate. Smith and also the firm's other managers are engaged on behalf of the shareholders, and that they were hired to pursue policies that enhance shareholder worth. Throughout this book, we focus totally on publicly owned companies; hence, we operate the belief that management's primary goal is shareholder wealth maximization. At the identical time, the managers know that this doesn't mean maximize shareholder value "at all costs." Managers have a responsibility to behave ethically, and that they must follow the laws and other society-imposed constraints that we discussed within the opening vignette to the current chapter. Indeed, most managers recognize that being socially responsible isn't inconsistent with maximizing shareholder value. Consider, for instance, what would happen if Linda Smith narrowly focused on creating shareholder value, but within the process, her company was unresponsive to its employees and customers, hostile to its area people, and indifferent to the consequences its actions had on the environment. Altogether likelihood, society would execute a large range of costs on the corporate. It's going to find it hard to draw in top notch employees, its products could also be boycotted, it should face additional lawsuits and regulations, and it's going to be confronted with negative publicity. These costs would ultimately cause a discount in shareholder value. So clearly when taking steps to maximise shareholder value, enlightened managers have to also mind these society-imposed constraints. It's at now where the researcher spreads an application of literature review onto testing Corporate Social Responsibility and its IMPRESSION on Financial Presentation. Subsequently, the researcher also stresses on the importance and implications of agency theory within the context of monetary management.*

**NOTE:** *The report contains bolded words for straightforward read and cursive words to assist keep track of small print.*



## **THE IMPRESSION OF CORPORATE SOCIAL RESPONSIBILITY (CSR) ON CORPORATE FINANCIAL PERFORMANCE (CFP)**

### **1.0 CORPORATE SOCIAL RESPONSIBILITY (CSR)**

#### **1.1 Introduction to CSR - Its Concept**

In financial management, in step with Khurshid (2017), Querol-Areola (2017), Galant and Cadiz (2017) and Bråtenius and Melin (2015) "Corporate Social Responsibility" (CSR) takes a step further in changing the mindset and traditional culture of the firm by giving organizations the chance to serve and build relationship with all stakeholders instead of merely acting in preference of shareholders by maximizing their wealth. Basically, to widen the scope of aims, objectives and goals towards moral and practical paradigms. (Mujahid and Abdullah, 2014) supported Khurshid (2017), Querol-Areola (2017), Galant and Cadez, CSR will be depicted as an extension of responsibility, beyond traditional and customary goals of firms, in conducting activities that ethically, socially and sensitively contribute towards social, cultural, economic and environmental development that entertains stakeholders' interests and promotes society's wellbeing at large. The activities may well be donations, community sponsorship, investments to prevent pollutions and employee benefits. (Bråtenius and Melin, 2015) this case explicitly implies how company structures its policies and practices and goes beyond legal obligations, compliance and company's interests to interact in social causes. Thus, CSR concept dictates the importance of organizations to think about the interests of society by taking responsibility for the IMPRESSION of their activities on customers, employees, shareholders, community and also the environment altogether aspects of their operation. These concept and objective of CSR shall be evident when organization's activities meet or exceed stakeholder's expectations.

#### **1.2 Introduction to CFP- Its Concept**

"Corporate Financial Performance" (CFP) depicts the flexibility of companies to utilize its assets to provide revenue. Thus, it refers to overall financial status of the firm in monetary terms of investment returns, return on assets and added value, over a period of your time. These measurements assist in creating distinctions with businesses in similar industry" (Khurshid, 2017).

#### **1.3 CSR and CFP Relationship**

Khurshid (2017), Querol-Areola (2017), Galant and Cadez (2017) and Bråtenius and Melin (2015) argue that there's a major relationship that connects CSR to CFP where it may be seen that firms with communitarian ideology that derive pleasure

CSR practices experience higher CFP compared to firms with individualistic ideology who purely invest time in maximizing shareholder wealth. This shows that CSR positively and negatively impresses CFP. This is often because, CSR are often seen through dual views where some managers view additional expenses of CSR as an ethical investment that invites competitive advantage whereas others view it as expenditure that reduces profitability creating competitive disadvantage. (Mujahid and this can be where the most problem lies, misinterpreting their entire concept of CSR- where CSR activities are alleged to be undertaken as long-term ethical and profitable investments instead of short-term additional cost and expenditure burden- because it exists on the motive of making betterment of society before improving CPF. Thus, Galant and Cadez (2017) believe it should be perceived within the positive side as its benefits overpowers its limitations. However, Cheng, Ioannou and Serafeim (2018) and Khurshid (2017) argue that firms fail to know how CSR positively IMPRESSIONs financial long-term performance because of trade-off between expenditure in CSR and profitability. This creates the importance of reviewing the literature of the positive and negative IMPRESSION of CSR on CFP.

#### **1.4 Factors that Contribute to Positive Relationship**

Many researchers argue that CSR positively Impacts CFP within the future depicting firm's profit maximizing CSR perspectives. The rationale being: -

##### **1.4.1 Freeman's Stakeholder Theory**

The paragraph below will be supported by "Freeman's Stakeholder Theory" developed in 1984 but supported and evaluated further by Galand and Cadez (2017), where the idea emphasizes that managers must act in interests of all stakeholders and not just fulfil shareholder wealth maximization goals. This is often because stakeholders are individuals with stake within the company and opposing their satisfactions can drastically and negatively deteriorate company image diminishing competitive advantage and reducing CFP. Therefore, if companies practice CSR, it could encourage shareholder engagement that positively IMPRESSION CFP. For example: employee satisfaction shall encourage high productivity, customer satisfaction shall promote product loyalty and word-of-mouth promotions and suppliers may give discounts- increasing overall CFP. (Galant and Cadez, 2017)

First, stakeholder engagement and trust. Galant and Cadez (2017) opines that the ideology of companies practicing CSR activities shows how the business is anxious and prioritizes objectives of groups aside from shareholders and is willing to require a broader and longer view than their own short-term profits.



This shows the trouble to make and be the change despite the CSR costs which will incur- clearly showing the genuineness to entertain society's betterment. So, Bråtenius and Melin (2015) adds that this positively IMPRESSIONs stakeholder's perception towards originations goals and culture as they're unable to imagine anything immoral when companies are being socially responsible. Thus, Khurshid (2017) supports dictating that stakeholders tend to develop greater trust and loyalty; especially consumers who begin supporting firms' by repeatedly purchasing their products- as they're confident towards the organization's ethical goals that cater better company image and reputation. Over time, companies are ready to cash in of CSR by charging premium prices and selling greater amount of their product and services- which indirectly offsets high CSR costs. This way, benefits exceeds costs allowing companies to determine their profits inclining above average clearly showing positive relationship between CSR and CFP.

**Second**, professional and private development. The implementation of CSR changes corporate culture and operations during which most of the tasks within the organization shall be geared towards following the moral code of conduct. (Khurshid, 2017) to realize this, every employee shall receive opportunity to undergo CSR training and development so as to successfully like CSR activities. Supported Galant and Cadez (2017) and Querol-Areola (2017), this increases their efficiency and effectiveness as they have a tendency to develop new skills and methodologies of executing tasks which will be applied throughout the organization. Also, Mujahid and Abdullah (2014) believe that employees may become better in their job

Because the essence of CSR may include work aspects which employees are passionate about-encouraging them to showcase greater interest and loyalty towards adapting the CSR culture of organization. This creates motivation to figure efficiently and effectively which will allow company growth and brand image increasing CFP.

**Third**, voluntary revealing. in step with Galant and Cadez (2017), Bråtenius and Melin (2015), Cheng, Ioannou and Serafeim (2018) and Querol-Areola (2017), CSR builds confidence in managers to arrange and record financial statements in true and honest browse despite high CSR costs might prune profit figures at the start. This will be as a result of, they are galvanized to showcase their efforts and sacrifices motive for society's betterment. Thus, Khurshid (2017) supports dictating that companies tend to deliver larger voluntary revealing that obliquely motivates investors to require a grip as a result of they gain trust at intervals the corporate and see lower profits because the beginning of larger CFP in future. This will be as a result of they see larger

CSR expenditures as prudent, and intelligent investment alternatives which may push up the price of stock at intervals the on the brink of future-allowing them to maximise stockholder wealth.

Thus, Galant and Cadez (2017) opines that investors unit willing to support CSR investments as they believe that 'risk desires reward. This indirectly could be a competitive advantage for companies as their goals of CSR is prepared to raise investors despite initial profit deterioration.

Not alone that, endless commitment to social contributions shall prune dealings costs and boost market opportunities- allowing businesses to prolong their aggressiveness national and internationally. This, over a quantity of it slow elevates the CFP. (Khurshid, 2017)

**Fourth**, intellectual capital (IC), in step with Khurshid (2017), could also be made public as Associate in Nursing assets that resembles company's main informational provide that possesses the ability to create and develop new product, maintain and attract new and existing customers and increase profits. It is the last word provide that contains every potential subject matter about but the company developed business enhancements. Thus, IC happens to be a helpful asset which will along improve company performance by delivering innovation ideas, worth creation opportunities and enhancing employee's power. IC consists of three efficiency elements, namely, 'human capital', structural capital' and 'capital employed'. (Khurshid, 2017) throughout this context, it's argued that CSR plays vital role in enhancing and developing IC as every practice show common interest. Therefore, the essence of CRS that encourages engagement with internal and external shareholders displays implementation of various fully totally different sensible actions that unit at intervals the kind of 'intangible resources. These refined actions are additionally secret formulations developed out of workers and management's experiences- that unit important to the conception of IC. (Khurshid, 2017) Thus, CSR practices check main contributors to the event of IC in terms of human capital, structural capital and organization's name. So, IC improvement creates future economic profit by reducing productions costs and increasing quality and equity return owing to firm's secret formulations and theories that unit able to improve name that promotes name and whole image. This may increase competitive advantage, profit and CFP. (Khurshid, 2017)

### **1.5 Factors that Contribute to Negative Relationship**

In distinction, many authors argue that CSR negatively IMPRESSIONs CFP at intervals the short basic cognitive process firm's

Profit increasing ancient views. The principle being: -





**First**, worth burden. In financial management, in step with Galant and Cadez (2017) and Bråtenius and Melin (2015), the last word and ancient goal of each firm is to maximise profit where each alternatives and practices ought to contribute to profit motive, if not, those practices shall be eliminated from the organization. Thus, Cheng, Ioannou and Serafeim (2018) believes, the conception of CSR might appear to be it involves simply moral and social practices that need to be implemented at intervals the alternatives of the organizations once it really involves additional costs for its implementation to be effective. This would possibly contradict with the profit motive of organizations as CSR's additional expenditures appear to be a financial burden that, in on the brink of future, can significantly prune profits then the CFP. (Galant and Cadez, 2017)

**Second**, agency relationship. Supported Bråtenius and Melin (2015), CSR negatively interferes with principal-agent relationship where agents unit required to act in accordance to shareholder's interests but generally oppose this responsibility owing to conflict in interest. Instead, agents tend to maximise personal wealth. This instance clearly shows that if managers do not appear to be willing to maximise shareholders wealth, obviously, they shall not entertain CSR significantly once CSR incurs additional costs that manager's unit focus in creating personal gain. Self-interested managers shall seldom extremely seldom prefer to choose short term CSR as they are a lot of interested by short financial profits than unsure long-term profit. Also, Bråtenius and Melin (2015) adds that, if managers acted in accordance with shareholders' interests, since they're 'agents', they shall solely maximize shareholders wealth and shall haven't any mandate to use CSR once it goes against shareholders maximization goals. This shows however CSR, if applied, could place company during a competitive disadvantage-negatively impacting CFP.

**Third**, Time and bulletin CSR could take long length of your time to herald positive results on CFP and to make positive company image not like advertisements. Hasan et al. (2016) typically, the defrayal on CSR could show lower profits, therefore deed businesses to experiencing prospects of not having any image. This can be as a result spent of CSR reduces amount left for advertising. Thus, to make image and earn profitable standing in brief term, corporations could typically pay on advertising to make smart image in customers mind. This shows however CSR might not be a quick thanks to improve profit, therefore negatively impacting CFP (Bråtenius and Melin, 2015).

**Fourth**, scarce resource. consistent with Hasan et al. (2016), Bråtenius and Melin (2015) and Kolisch (2015), the thought of implementing CSR in business show that companies currently have extra goal over

Associate in Nursing higher than shareowner wealth maximization- wherever CSR might not simply be an interior structure observe however an external observe of business humouring in social services and stakeholder's social affairs. Thus, Bråtenius and Melin (2015) adds that if CSR practices widen with everybody inspired to perform social accountable activities, there's high possibilities of unwittingly misallocating and misappropriating scare resources. Therefore, misuse of things of production that area unit restricted in offer could cause deficiency to fulfil the requirements and wishes of shoppers. This might lead to corporations affected by cost that if any of the choices area unit taken wrong, it will hugely have an effect on CFP. The decreasing FP shall cause stakeholders to modify to different corporations UN agency is also a lot of profitable- additional influencing CFP.

**Fifth**, packaging and scrutinization. consistent with Bråtenius and Melin (2015), intensive and long-run observe of CSR in organizations could improve the corporate image wide that 'going green' or 'being socially responsible' shall be the terms utilized by societies to deal with the organization. This suggests the corporate shall be common in behaving ethically within the eyes and a focus of society. As a result, Bråtenius and Melin (2015) evaluates that their area unit high possibilities for the corporate to face journalists, reporters and media. At this level of packaging, if in any respect the corporate becomes a suspect of 'insincerely being socially responsible' wherever promoting CSR was simply a medium to enhance image and boost stakeholders confidence, or, happens to form an error by 'not playacting ethically'; for example: mistake of harming animals and discreetly polluting stream then, this side of CSR shall destroy company's image, name and profit drastically impacting CFP. Thus, an organization that doesn't observe CSR is also free from these treats.

### **Conclusion (Point of View and Opinion)**

It can be evaluated that CSR has positive and negative IMPRESSION on CFP. However, the main theme that can be obtained from this literature review is that CSR is a modern concept and can be made as a modern financial goal compared to traditional goal of shareholder wealth maximization. The goals at the end of the day do create and generate profits, but the duration of time and the technique may be different. Here CSR may take longer time to generate profit and spread awareness of its importance to its stakeholders, but managers should treat is as an investment rather than an unnecessary expenditure. It is very important for managers to understand the concept of CSR. This is why this topic has been chosen as it is a vital area that deserves discussion including views and opinions of various authors.





## **AGENCY THEORY: A LITERATURE REVIEW**

### **Area of Discussion: Do Agents Act in Accordance to Principal's Interests?**

#### **2.0 Agency Theory**

##### **2.1 Formation of Agency- Its Origins**

In this context of economic management, in step with Barrington and Stimpson (2013), big business organizations like public restricted companies possess opportunities to spice up big sums of capital through provision of shares that unit purchased by sizable quantity of shareholders. Keown, Martin and Petty (2017) opine that this makes shareholders, homeowners of the company, UN agency have ability to handle possession and confront risks and returns of their shares but inability to participate in strategic and operational deciding, managing, running and dominant the business. Thus, shareholders elect directors and managers to perform these responsibilities on their behalf- creating separation between possession and management. (Barrington and Stimpson, 2013) This separation express an important instrument relationship between shareholders Associate in Nursing managers; basic cognitive process the existence of 'agency' gift - that's at intervals the kind of associate degree 'Principal-Agent' relationship higher referred to as 'Agency Relationship'. (Brigham, Houston and author, 2007)

##### **2.2 Agency Relationship and Rising Agency Downside**

Based on weight unit (2010) and Ross (2007), agency relationship finds its roots from the widening gap between 'shareholder's ownership' and 'manager's management responsibilities'- where it'll be defined as a result of the arrangement at intervals that one party referred to as 'principal' (shareholder) appoints or hires another party is conscious of as 'agent' (manager) to act in accordance to their interest, below instrument agreement. This correlation of principal and agent itself resembles 'agency'. Keown, Martin and Petty (2017) adds that, 'below this circumstance of agency agreement, managers unit required to position goals of stockholder as their primary objectives'. However, {this is this is typically this will be} not constantly the case as managers usually perform opportunist actions motive towards their personal interests- at the expense of shareholders. This expressly depicts 'conflict of interests' owing to the assorted objectives- once shareholders' aim 'shareholder wealth maximization' whereas managers' aim 'personal wealth maximization'. (Ng, 2010) Thus, this non-congruent diverging goal sort the foundations of 'agency problem' that photos managers at intervals the organization as 'wealth

seekers and risk averse' not like principals UN agency unit 'profit seekers and risk neutral'. (Ng, 2010) this case marks the emergence, development and intervention of 'Agency Theory'.

##### **2.3 Agency Theory and Area of Dialogue**

According to Panda and Leepsa (2017), weight unit (2010) and Brigham, Houston and author (2007), agency theory represents the oldest model at intervals the literature of management and economics- that intensively studies and explains the principal-agent relationship, agency problems and agency costs suggest imperative remedies that align every party's interest to mitigate problems. However, this theory concentrates heaps of on the agent's side in terms of agent being the matter maker rather than principal. Ross (2007), Brigham, Houston and author (2007) and weight unit (2010) in financial management, agency theory pertains to a pair of types of 'principal-agent' relationships, namely: 'shareholder and managers' and 'shareholders and creditors. However, the following paragraphs shall consider 'shareholder-manager relationship' in terms of critically discussing the various views of the various authors towards "factors that contribute to agency conflict and factors that mitigate agency conflict" through the model of agency theory.

##### **2.4 Factors Contributing to Agency Conflicts**

Many authors argue that managers do not act in accordance to shareholder's interests. The principle being: -

**First**, separation of possession and management and diverging goals. Keown, Martin and Petty (2017) and Panda and Leepsa (2017) argue that the goal of the firm is to maximise stockholder wealth where managers unit utilized to realize this for shareholders. This shows separation between homeowners and managers where the managers unit merely agents to help shareholders succeed their goals, but shareholder's goal is not manager's goal. (Panda and Leepsa, 2017) So, this show every parties having fully totally different goals with managers running the firm in step with their personal goals, interests and desires like increasing their own wealth in terms of salaries, fringe edges, perquisites and vary of share decisions at the expense of shareholders.

Smith (2011) adds that this behaviour is Associate in Nursing outgrowth of basic human attribute that strives to maximise personal gain out of rationality and motivation. As a result, separation fails stockholder in observance agents and achieving wealth maximization-contributing to agency conflict.

**Second**, risk preference. Ross (2007), Panda and Leepsa (2017) and Smith (2011) argue managers unit in positions where their gain level is set by company performance. This encourages them to run the company in risk- free methodology by diversifying money into fully totally different quality classes and



investment merchandise, minimizing risky investments, stock risks and financial leverages. (Keown, Martin and Petty, 2017) This reduces the prospect of bankruptcy and group action capital loss-rising company performance and managers employment continuity. In distinction, Keown, Martin and Petty (2017) opine that this risk loath angle may not be in favour of shareholders UN agency unit generally risk neutral. this will be as a results of stockholder belief 'risk desires reward' that risky investments possess high prospects of skyrocketing their share worth. (Keown, Martin and Petty, 2017) but, Brigham and Houston (2009) evaluates that since managers unit elective to run the company, their decision to object risky investments causes shareholders to lose profitable opportunity-leading to agency costs. This shows but every parties possess fully totally different risk exposure creating conflict.

**Third**, loss implies self-satisfying actions discreetly taken by managers whereas not shareholders knowledge; knowing the costs of risks shall be borne by shareholders. (McColgan, 2014) Thus, Panda and Leepsa (2017) support dictating managers unit galvanized to inconspicuously invest in step with personal skills that cater for personal gains owing to having lower or no possession and lesser motivation to require a grip and maximize shareholders wealth. McColgan (2014) argues this self-interest investment might increase the importance of managers towards the company, allowing them to mention higher yield as they are irreplaceable. Thus, egocentric managers generally advantage of moral hazard to cater for personal profit at the expense of shareholders-creating issue in observance these actions as they are discreetly performed; thus, elevating agency costs. (Panda and Leepsa, 2017), (Smith, 2011) and (McColgan, 2014)

**Fourth**, maintained earnings. supported McColgan (2014) and weight unit (2010), managers unit generally pleased from the goal of accelerating stockholder wealth to specializing in business growth- as a results of larger business size generates higher earnings which will be reinvested into business core for future investment comes rather than being paid out as dividends to shareholders. Barrington and Stimpson (2013) adds that business growth permits managers to control a far larger and well-known business that grants larger power, standing and sovereignty- subsidization them higher remuneration and job security for the nice work that they're doing. However, McColgan (2014) and Smith (2011) argue that this aim of business diversification conflicts with shareholders as they wish to be paid dividends rather than having it maintained. this will be as a result of, diversification reduces returns and worth of the firm- damaging overall stockholder wealth. but agents still support business growth

although it harms principal interests as standing is substantial. (Ross, 2007), (Brigham, Houston and author, 2007) and (Ng, 2010)

**Fifth**, data property. Barrington and Stimpson (2013) argue that managers possess the authority to rearrange, organize, coordinate, command and management the full management by taking important alternatives at every interval. Thus, McColgan (2014) supports dictating they are folks fully indulged in business management activities-where they are awake to either side, update and performance data of the business. In distinction, McColgan (2014) to boot argues shareholders own the business and appearance every likelihood to maximise their wealth- but unit unaware of business alternatives and performance unless aware by managers. Often, homeowners do not appear to bear in mind or the data does not reach them inflicting info property. (Panda and Leepsa, 2017) this may increase the possibilities of conflict in agency relationship.

**Sixth**, length of involvement. Supported Keown, Martin and Petty (2017), the employment turnover of managers is additionally higher than shareholders UN agency possess business possession. Owing to the short term of employment, managers unit alone interested by the short returns conflicting with shareholders UN agency unit anxious to grasp future cash flows. (McColgan, 2014) Thus, managers tend to maximise personal wealth and government compensation by manipulating earnings and reducing R&D expenses before retirement- that's all against prime goal of firms. This creates conflict and can increase agency costs. (McColgan, 2014)

## 2.5 Consequences of Agency Conflict

The reasons of managers not acting towards shareholder's preferences finishes up in negative consequences referred to as 'agency costs. Agency costs could also be pictured as a result of the costs borne by shareholders owing to agency conflict. This cost can be divided into a pair of categories, namely: 'indirect costs'- that refers to the foremost effective numerous forgone owing to managers minimizing share worth and 'direct cost'- that happens in a pair of practices namely 'corporate expenditure' and 'monitoring, bonding and residual loss. (Brigham, Houston and author, 2007) "Monitoring costs" unit expenses incurred by shareholders for perceptive, accessing and supervising manager's appraisal at intervals the business. These might embrace supervisors' payment, board of director's maintenance, appraisal and behaviour analysis and compensations. Also, manager's recruitment, development, work expenses come below observance costs (McColgan, 2014).

"Bonding costs" unit expenditure incurred in coming up with specific framework that guides managers to manage in step with company's systems.



This binds managers to point out commitment towards the instrument obligation to agency relationship- indirectly limiting their self-interest activities. For example: obligatory recording and preparation of economic statements and mandatory distribution of dividends opposing actions of retaining earnings. Observance worth decreases as bonding rises. (Brigham, Houston and author, 2007) and (McColgan, 2014) "Residual Loss" is worth acquisition out of agency losses over and better than observance and bonding practices. For example: managers still taking self-interested alternatives. So, to remain residual loss lower, observance and bonding worth ought to be used. (Brigham, Houston and author, 2007)

## 2.6 Factors Mitigating Agency Conflict

In distinction, many authors argue that managers have important incentive to act in shareholders' interests. The reasons being: -

**First**, Provision in company act. In step with weight unit (2010), The Malaysian Company Act 1965 requires managers to arrange financial statements and acquire it audited by freelance external auditors. This will be so as that the auditors shall communicate and inform shareholders about the company's performance that if the financial statements' unit reliable, relevant and given by managers in true and honest browse. Panda and Leepsa (2017) adds that the thought of auditors being a middle man throughout this situation indirectly compels managers to act in shareholders' interest as every act of manager shall be reflected in financial statements. Also, the act encourages companies to carry out Annual General conferences (AGM) to allow shareholders be fully aware of the company by asking queries about companies' activities and managers decisions. This so as that shareholders will eliminate data property and consequently employ or terminate managers to reinforce agency relationship. (Ng, 2010)

**Second**, group action compensation and possession. Managers unit required to be fairly compensated reciprocally of managing and dominant the company at intervals the name of 'going concern'. Ng (2010) and ross (2007) argues that despite various fully totally different compensation packages, every manager deserves to receive 'annual salary' that funds living desires and basic expenses; 'yearend bonuses' in step with performance and profit of company and 'opportunity to buy for shares and be a section of company's ownership' that recompenses for continuing performance. This best compensation shall be allowing managers to buy for shares as a result of indirectly this shall motivate them to maximise share worth knowing they check a section of firm's possession. (Ng, 2010)

Thus, generally managers unit awarded 'performance shares' on basis of company performance or

'executive stock options' allow them to buy for shares at given worth in future. This way, shareholders shall succeed retaining and attracting managers- reducing gap between diverging interests. (Ng, 2010)

**Third**, info flow. in step with weight unit (2010), the Securities Commission and Bursa Asian country requires shareholders to perform 'management appraisal' by establishing internal audit committees and effective audit and financial news, so as that company's annual report can address risks, solutions to risks and current and expected company performance details. Despite managers active data asymmetry, this way, stockholder shall be timely notified information which may facilitate them appraise manager's performance and make recruiting-dismissal decisions effectively.

**Fourth**, linking management remuneration to stockholder wealth. Managers unit given 'yearly performance objectives' like increasing sales and profits, where, if these targets unit exceeded, then managers shall be rewarded with motion remunerations as they succeed elevating company performance. This way, managers unit anticipated to maximise stockholder wealth in commit to increase personal wealth. (Ng, 2010)

**Fifth**, commerce shares and threat of takeover. In big companies, self-interested managers that escape stockholder observance out of ingenuity unit at high risk of obtaining major shareholders such as insurance, government investment and pension funds, disposing shareholdings. The disposal of shares drastically reduces share worth making firm in danger of takeover. the strategy of takeover shall automatically dismiss all managers upon appointment of latest management inflicting loss of employment. this means the essence of deterrence applied in orienting agents towards principal's goals. (Ng, 2010)

**Sixth**, threat of firing resembles another deterrent issue where managers unit at the verge of getting ousted if they begin intensively dominant shareholders alternative mechanism. This happens when diversification of firm attracts many shareholders and under control of managers unit unable to vote against managers. (Brigham, Houston and author, 2007) Thus, to overpower managers control authority, shareholders have begun firing managers significantly if company performance is deteriorating. This will be evident with Yahoo, Xerox and Coca-Cola once they were ousted once being CEO for temporary time. (Ng, 2010)

## Conclusion (Point of View and Opinion):

Purpose of browse and opinion based on the literature review designed for the motion: "Do Agents Act in Accordance to Principal's Interests?" it's going to be expressly evaluated that heaps of authors unit against this statement whereas many





professional the statement. These contradicting views of authors emerge owing to the assorted views and perception used in gazing but agency theory addresses the matter and brings solutions to mitigate the conflict. Thus, this whole literature review is written on the grounds, essence and context of agency theory but the content may well be a compilation of literature reviewed from the essential views and opinions of authors UN agency delivered their understanding and interpretations through legitimate journals. Supported the essential findings beyond, it's going to be evaluated that the conception of agency emerged for the basic delegation of authority and responsibility to run an organization throughout a scientific and efficient manner. However, conflicts of interests between a pair of fully totally different parties created problems of agent objecting to perform for principal's interest owing to self-interest. This develops agency costs. However, the explanation behind the matter could also be satisfied. This shows that agents might go off tract but could also be trained to act in principal's interests through implementation of agency theory. This becomes the sole reason for reviewing the literature where agency problems in organizations today merited to be understood and solved to maximise stockholder and managers wealth and cater for higher business and economic prosperity.

## REFERENCES

1. Barrington, K. and Stimpson, P. (2013). *Cambridge Igcse Business Studies. 4th ed.* Hodder Education, pp.1-92.
2. Bråtenius, A. and Melin, E. (2015). *The IMPRESSION of CSR on financial Performance. MSc, Accounting, Strategy & management, [online] pp.11-38.* offered at: [http://studenttheses.cbs.dk/bitstream/handle/10417/5336/anna\\_linnea\\_helena\\_braatenius\\_og\\_emil\\_ie\\_josefin\\_melin.pdf?sequence=1](http://studenttheses.cbs.dk/bitstream/handle/10417/5336/anna_linnea_helena_braatenius_og_emil_ie_josefin_melin.pdf?sequence=1) [Accessed twelve Apr. 2018].
3. Brigham, E. and Houston, J. (2009). *Fundamentals of economic management. 12<sup>th</sup> ed.* Mason: South-Western Cengage Learning, pp.18-20.
4. Brigham, E., Houston, J. and writer, E. (2007). *Fundamentals of economic management. 10<sup>th</sup> ed.* Mason, OH u.a.: Thomson, pp.20-26.
5. Cheng, B., Ioannou, I. and Serafeim, G. (2018). *Company Social Responsibility and Access to Finance. [online] Nrs.harvard.edu.* offered at: <http://nrs.harvard.edu/urn3:HUL.InstRepos:9887635> [Accessed twelve Apr. 2018].
6. Galant, A. and Cadez, S. (2017). *Company social responsibility and financial performance relationship: a review of measure approaches. Economic Research-Kosovska Australiana, 30(1), pp.676-693.*
7. Hasan, I., Kibeis', N., Liu, L. and Wang, H. (2016). *Company Social Responsibility and Firm financial Performance: The Mediating Role of Productivity. Journal of Business Ethics, [online] pp.1-34.* Offered at: [https://helda.helsinki.fi/bof/bitstream/handle/123456789/14088/BoF\\_DP\\_1607.pdf](https://helda.helsinki.fi/bof/bitstream/handle/123456789/14088/BoF_DP_1607.pdf) [Accessed twelve Apr. 2016].
8. Knawel, M., Khanam, F., Nasreen, S. and Hameed, S. (2013).
9. *IMPRESSION of company social responsibility on the firm's financial performance. IOSR Journal of Business and Management, [online] 14(5), pp.67-74.* offered at: [https://scholar.google.com/scholar?hl=en&as\\_sdt=0%2C5&q=IMPRESSION+of+corporate+social+responsibility+on+the+firm%E2%80%99s+financial+performance&btnG=](https://scholar.google.com/scholar?hl=en&as_sdt=0%2C5&q=IMPRESSION+of+corporate+social+responsibility+on+the+firm%E2%80%99s+financial+performance&btnG=) [Accessed twelve Apr. 2018]. Keown, A., Martin, J. and Petty, J. (2017).
10. *Foundations of finance. 4th ed.* Boston: Pearson, pp.1-36. Khurshid, M. (2017). *IMPRESSION of company Social Responsibility on financial Performance: The role of Intellectual Capital. university analysis Journal, [online] (AIC), pp.247-263.* Available at: [http://www.cityuniversity.edu.pk/curi/Journals/Journal/special\\_aic\\_16/25.pdf](http://www.cityuniversity.edu.pk/curi/Journals/Journal/special_aic_16/25.pdf) [Accessed twelve Apr. 2018].
11. Kolisch, H. (2015). *can CSR pay? – The IMPRESSION of CSR on financial Performance. A Comparison between land and thus the us. activity, Management and Social sciences., [online] pp.2-11.* offered at: [http://essay.utwente.nl/67415/1/Kolisch\\_BA\\_MB.pdf](http://essay.utwente.nl/67415/1/Kolisch_BA_MB.pdf) [Accessed 12 Apr. 2018].
12. McColgan, P. (2014). *Agency theory and company governance: a review of the literature from a GB perspective. Accounting & Finance. [online] offered at: https://s3.amazonaws.com/academia.edu.documents/32710879/agency\_theory.pdf?AWSAccessKeyId=AKIAIWOWYYGZ2Y53UL3A&Expires=1523451693&Signature=Uo0QY92t3KPU5ZqGm7LOFc40rec%3D&responsetype=inline%3B%20filename%3DAgency\_theory.pdf* [Accessed eleven Apr. 2018].
13. Mujahid, M. and Abdullah, A. (2014). *IMPRESSION of company Social Responsibility on companies Financial Performance and Shareholders wealth. European Journal of Business and Management, [online] 6(31), pp.1-8.* offered at: <http://citeseerx.ist.psu.edu/viewdoc/download?doi=10.1.1.685.5627&rep=rep1&type=pdf> [Accessed twelve Apr. 2018]. Ng, K. (2010). *financial management. 1st ed.* Oxford: Oxford Press, pp.12-15.
14. Panda, B. and Leepsa, N. (2017). *Agency theory: Review of Theory and proof on Problems and views. Indian Journal of company Governance, [online] 10(1), pp.74-95.* Available at: <http://ijc.sagepub.com> [Accessed eleven Apr. 2018].
15. *Literature Review on Company Social Responsibility and Agency Theory. Querol-Areola, E. (2017). The link of company Social Responsibility and Financial Performance below company Governance Aspects in selected Southeast Asian Companies. Management, Economics, Law, Social Sciences and affairs, pp.38-158.*
16. Ross, S. (2007). *Financial management fundamentals in Asian country. 1st ed.* Shah Allam: McGraw-Hill (M), pp.10-15.



- 
17. Smith, T. (2011). *Agency Theory and Its Consequences. M.Sc. Finance & Strategic Management.* [online] offered at: [http://studenttheses.cbs.dk/bitstream/handle/10417/2798/thomas\\_ruediger\\_smith.pdf](http://studenttheses.cbs.dk/bitstream/handle/10417/2798/thomas_ruediger_smith.pdf) [Accessed 11 Apr. 2018].





# THE IMPORTANCE OF E-GOVERNMENT AND MASS MEDIA

## (As an example of the People's Republic of China)

**M. Siddikova**

*A senior lecturer in the University of World Economy and Diplomacy*

### ABSTRACT

*This article analyzes the features of e-government and the unconformity of traditional management methods of governments to the people's requirements of the information society. Furthermore, it considered about using of mass media in the dialogue with the people on the example of the People's Republic of China.*

**KEY WORDS:** *dialogue with the people, mass media, Internet, e-government.*

### DISCUSSION

*"The main purpose of the creation of a government was to maintain just and rational social conditions of living for people...".*

*Aristotle.*

One of the urgent requirements of the society is that the government implements modern governance adapted to modern innovations, clashes and exchanges of civilizations to ensure the well-being of the country's citizens and society, to effectively protect their interests. It is known from history that when a new type of media emerges, it always brings changes in the political sphere as well. This can also be seen in the emergence of the press and the dramatic changes that radio and television have made in the world of politics. The Internet has not only changed people's lifestyles, but has also given a new look to politics, for example online politics. The online audience in the virtual world was in a sense able to influence real politics with its power. The development of media on the Internet is encouraging many scholars to study the "hidden" influences of different countries in the political system. Even

people who were not so interested in politics in the past are becoming more and more interested in it through the Internet. Especially the ones who know their rights as violated try to protect their rights through the network.

The network has already become a platform that gives the public the right to observe, comment and even discuss political processes. In a virtual audience, the impact power of society is increasing. In many countries around the world, political bodies and organizations are also creating their own news sites, realizing the importance of the Internet audience, and are giving opinions, comments and interpretations on various problematic situations. This is positively received by the audience with great interest. It is significantly important to follow the experience of the government of the People's Republic of China, which has a population of about one and a half billion in order to study the way of providing information to nearly a quarter of the world.

Chinese scholar Wang Linlin points out in his book, *The Online Age and Government Updates*, that while the information technology revolution has not radically changed government regulations, it has had an impact on the government system, even the Communist Party of China. It is now clear that the government cannot fully meet the demands of the people when it conducts governance based solely on its traditional characteristics. This, in turn, led to government updates in the Internet age, and the

<sup>1</sup>Wang Linlin (王淋淋). *Government updates in the Internet era (网络时代的政府更新)*. Institute of Public Administration Studies (国家行政学院出版社). 2013. — page 46.



number of theoretical researchers in the field also increased. The Eighteenth Plenum of the Communist Party of the People's Republic of China discussed such important issues as "strengthening the social governance of the Internet, promoting the orderly movement of Internet standards", "paying high attention to Internet security."<sup>2</sup> The advancement of such issues and the thorough study at the highest government level indicate that the government leaders of PRC are paying close attention to changes in the political environment. The "42nd China Internet Development Statistical Report" released by the China Internet Information Center (CNNIC) on August 20, 2018, shows that in the first half of 2018, China's Internet population reached 802 million.<sup>3</sup>

This number ranks first among the world's countries due to China's large population. Current moment which is full of great changes is thought to be in turn requiring the updates from the government. During a visit to Peking University in 2004, Lee Bolinger, the president of Columbia University in the United States, said: "Currently, three different forces are making a difference in the world's development, and these forces, which are also evident in China, include:

- An economy that is constantly evolving in the process of globalization;
- Government activities;
- The Internet"<sup>4</sup>.

Today, it is known that the governments of many countries around the world use the Internet effectively to implement their functions. Internet media, unlike newspapers, radio and television, has enormous power and influence.

Although the online community and online politics are virtual, its functions and effects are by no means virtual. It can have a serious impact on real governance. According to Chinese scientists, the new government should manage the Internet world in harmony with the free spirit, especially to find ways

to promote a positive Internet world.<sup>5</sup>

With the rise of online networks, the PRC government has taken the necessary control actions in a timely manner. At the meeting of the Political Department of Central Committee (中共中央政治局) on April 23, 2007, important aspects of the development of China's unique Internet culture were highlighted. In September 2007, the main topic of the department's eighteenth further training course was "the Development of World Internet Technology and the Formation and Management of Chinese Internet Culture." In his speech at the event, former Chinese President

Hu Jintao said, "The rapid development of Internet culture has played an important role in disseminating messages, acquiring knowledge, promoting the party's teachings and priorities, while bringing new themes to China's socialist culture. It is necessary to form and manage the Internet culture in a creative spirit, to meet the growing spiritual needs of people"<sup>6</sup>.

According to Chinese researchers, the following should be analyzed for the effectiveness of government activities in the online information age<sup>7</sup>:

First, the government is no longer just a traditional authoritarian body, but a modern system that serves the public.

Second, changes in the activities of citizens, they are now becoming the owners of civil society, not traditional citizens.

Third, the changes in the sources of the government's fairness, especially, the increase in the significance of the people's authority and opinions on the net place can influence the government on remaining the same or becoming different.

Fourth, the widespread development of online media today and the active participation of the audience in it has created a great opportunity for free critical thinking. The lifestyle of the online community is based on openness, diversity, liberalism, and citizens in the online community are also becoming more independent and individualized. As a managing power, the government has to take steps to maintain its authority in order to adapt to the new form of society.

Fifth, the comprehensiveness of government activities should be reflected mainly in ensuring the well-being of citizens.

In order to adapt the government to the modern environment, to answer the questions in it, and to increase the effectiveness of its implementation, it is necessary, first of all, to involve the public opinion in

<sup>2</sup>Wang Linlin (王淋淋). Government updates in the Internet era (网络时代的政府更新). Institute of Public Administration Studies (国家行政学院出版社). 2013. — page 1.

<sup>3</sup>[http://www.cnnic.net.cn/gywm/xwzx/rdxw/20172017\\_7\\_7047/201808/t20180820\\_70486.htm](http://www.cnnic.net.cn/gywm/xwzx/rdxw/20172017_7_7047/201808/t20180820_70486.htm) China Internet Research Information Center (中国互联网罗信息中心) (CNNIC). 38th Statistical Report on the Development Status of the Chinese Internet. 20.08.2018.

<sup>4</sup><http://www.southcn.com/tech/news/tech/news/200404110015.htm>, 2008.

<sup>5</sup>Wang Linlin (王淋淋). Government updates in the Internet era (网络时代的政府更新). Institute of Public Administration Studies (国家行政学院出版社). 2013. Page 31.

<sup>6</sup>This source. —page-42.

<sup>7</sup>This source. —page 45-47.



the government mechanism and strengthen its response. According to a survey conducted by the Chinese Youth Newspaper (中国青年报) on online public opinion: 61.4% of the public believe that "it is very convenient to tell the truth through the internet"; 67.2 per cent of the public agreed that "stratification and many similar differences in online audiences have decreased", the distance between government agencies and the general population has become closer; According to 57.3% of the population, online public opinion polls by officials "help to ensure harmony between the government and the population".<sup>8</sup>

In virtual power, knowledge and information form the basis of organizational power. Chinese scientists compare the different aspects of virtual government and traditional government and classify them as follows.

**Table 1. Different aspects of virtual government and traditional government**

The objects of the research	E-government	Traditional government
<b>Organizational structure</b>	Online	Functional
<b>Type of activity</b>	Direct contact with society, businesses and citizens	Indirect concern for society, businesses and citizens
<b>State</b>	Active, changeable, elastic	Quiet, stable
<b>Sources</b>	Knowledge, talent, information	Power, authority, property
<b>Leader (head)</b>	Acts as a director in government actions	The scale of middle-level managers is wide and there is a lack of coordination
<b>The method</b>	Soft, collaborative, coordinated work	Standardized uniformity, struggle between ministries
<b>The point (place) of activity</b>	Electronic point	Own points of each one
<b>Function</b>	Socialization, popularization	Closedness

For several years, many countries around the world have been organizing virtual government in practice. According to the World Market Organization (WMRC), in terms of region, government virtualization is highest in North America at 51 percent, Europe and Asia at 34 percent, and the Middle East, Russia and South America it is from 27.7 percent to 31.1 percent.<sup>9</sup>

<sup>8</sup> Hou Jaosiao (侯兆晓). Public opinion is becoming a bridge to democracy (网络民意渐成民主渠道) // The Democracy And Law Journal (民主与法制), 2008. #16. — pages 42-44.; Wang Linlin (王淋淋). Government updates in the Internet era (网络时代的政府更新). Institute of Public Administration Studies (国家行政学院出版社). 2013. — page 78.

<sup>9</sup> Liu Лю Фенгюань (刘凤元). The analysis about the development and future of "E-government" (浅析“虚拟政府”发展趋势及其启示). Business Period Journal (商业时代), 2008. 20 №, page 10; Wang

The government's openness to the public, especially through the media, can be seen it has developed since the foundation of the U.S. White House Press Office and its Speaker in the 1950s. The spokesman had officially become a political system in the United States. Today, this system has been significantly refined, the content of which mainly includes issues related to major government and other important events, emergencies, and the public interest in general. This, in turn, implies a system for answering public questions. In China, however, the system gradually began in the 1980s. In 1983, the working group of the foreign propaganda department of the Central Committee (中央对外宣传领导小组) made a "proposal to establish" a system of press conferences "and strengthen the activities of international journalism." (关于实施“设立新闻发

Linlin (王淋淋). Government updates in the Internet era (网络时代的政府更新). Institute of Public Administration Studies (国家行政学院出版社). 2013. — page 93.



言制度”和加强对外国际记者工作的意见<sup>10</sup>。On April 23 of that year, the Chinese Journalists Association first introduced a new press secretary of the State Council for International Journalists officially announcing the establishment of a government press conference system in China.

Since the new century began, the implementation of a number of legal documents, such as the “Regulation on Information Transparency of the Government of the People’s Republic of China,” has become the political and legal basis for the functioning of the government press conference system. Following the rapid spread of SARS in the country in 2003, the Ministry of Health held a total of 67 press conferences from early April to June 24, 2003.<sup>11</sup> It was the period with the most press conferences in the country’s history. For more than thirty years, the Chinese government press spokessystem has been carrying out special tasks such as shaping public opinion and improving the government’s image. At the same time, it provides the media of different countries with the necessary information about China.

As a result of the rapid development of the Internet, the public’s need for information is growing. In accordance with the need of the public and the initiative of the government, an online press speaker system was established. On September 1, 2009, the Guiyang Municipal Government of Guizhou Province announced the introduction of an online press speaker system. This system was the first sign that the PRC government was officially launching an online press speaker system<sup>12</sup>. The government news site of China’s Shanxi Province has been running a “Communication with the Public” page since 2009 to answer every question asked by the audience. This, in turn, is important in ensuring that the audience is calm and stable towards the issues of that territory.<sup>13</sup>

After that, government online press services began operating in many parts of the country. This system now serves as a connecting bridge between the government and the population. According to a survey of 3,009 people conducted by the China

Youth Newspaper (中国青年报) in collaboration with the Beijing Income Market Research Company, 64.5% of respondents believe that the introduction of an online press speaker system means the government’s high public opinion, 80.3% and people hope that the city government where they live will introduce a similar system.<sup>14</sup>

Today, the political activeness of the Weibo network is increasing in China. According to Chinese experts, Weibo is a new type of media platform that has attracted a lot of attention. Various government and ministry agencies are also expanding their administrative capabilities by creating their own Weibo pages.<sup>15</sup>

In the second half of 2009, for the first time, the Taibuan Wang website of the Taoyuan County Government of Hunan Province was launched. It was the first government agency to launch a Weibo page. Later, the Weibo pages of the Yunnan Provincial Government, such as Weibo Yunnan, and Beijing’s Ping an Beijing, were organized. At the same time, the official Weibo pages of party leaders have also proliferated.

According to the e-government research center of the China Institute of Administrative Studies in February 2012, the total number of government pages registered on the Weibo pages of Chinese national news agencies Xinhua, Xinglang, Tengxun, Jenmin reached 50,561, of which 32,358 are government and party bodies and 18,203 are the official pages of the employees working in the party and government.<sup>16</sup>

Weibo has quickly become China’s big source of information, with the opinions well-known experts and scholars, as well as the voices of various categories of ordinary people. This vast information space has provided a convenient opportunity for the government to manage and gain the trust of the public. In the case of Beijing, the Beijing City Press Service officially launched the Beijing Weibo Press Group (北京微博发布厅) in November 2011. The page was a “joint service” launched by 21 ministries and seven speakers. It was the first regional-level Weibo press distribution group in the country.

Wang Shenshen, a Chinese expert, stated that the Chinese government’s online services, such as the government’s Weibo page, government websites or online press speaker system, are all in the early stages

<sup>10</sup>Wang Linlin (王淋淋). Government updates in the Internet era (网络时代的政府更新). Institute of Public Administration Studies (国家行政学院出版社). 2013. — page 174.

<sup>11</sup>This source. — page 174.

<sup>12</sup>Wang Linlin (王淋淋). Government updates in the Internet era (网络时代的政府更新). Institute of Public Administration Studies (国家行政学院出版社). 2013. — page 174.

<sup>13</sup>Zhang Chunhua. Sociological Interpretation of Net-Mediated Public Sentiment. Social sciences academic press. Beijing. —P.086.

<sup>14</sup>Wang Linlin (王淋淋). Government updates in the Internet era (网络时代的政府更新). Institute of Public Administration Studies (国家行政学院出版社). 2013. — page 174.

<sup>15</sup>Zhang Chunhua. Sociological Interpretation of Net-Mediated Public Sentiment. Social sciences academic press. Beijing. —P.086.

<sup>16</sup>E-Government Research Center of the China Institute of Administrative Studies. <http://www.nsa.gov.cn>





of quality and content, and need to improve skills and learn the benefits of foreign experience<sup>17</sup>.

The speaker of a government online press conference should not be the same as traditional press speakers, he said:

- ✓ creative approach, devotion to work not with sense of compulsory;
- ✓ quick response to public opinion;
- ✓ having the ability to lead social opinion in its own way;
- ✓ be able to quickly resolve misunderstandings in the community;
- ✓ being based on facts;
- ✓ Speak with dignity, avoid arrogant and empty talk, and do as much as possible to prevent the online public from being skeptical of important political events.

A number of laws have been enacted by the Government of the People's Republic of China in recent years to ensure the legal participation of the online public in politics and to prevent unmanageable situations. For example, "Resolution of the Standing Committee of the National People's Congress on Internet Security" ("全国人民代表大会常务委员会关于维护互联网安全决定"), "Internet Information Service Management Measures" ("互联网信息服务管理办法"), "Principles governing the publication of information by Internet sites" ("互联网站从事登载新闻业务管理暂行规定"), "Emergency Response Rules" ("突发事件应对法") and the adoption of a number of similar legal documents have provided the legal basis for public participation in politics on the Internet and the activities of online media in general. However, the Chinese believe that the rapid growth in the number of Weibo users shows that the current legislation is still insufficient.

In an informed society, the influence of the media on international politics, economics, culture and other areas, as well as on people's thinking, work and life is expanding. That is why it is more important than ever to form a sense of social responsibility for every branch of media.

This means that China's major branches of media seek to integrate with the Internet, providing information in economic, political, cultural, social and environmental areas. It is also one of the priorities of the media policy to provide timely comment on the rise in real estate prices, to pay serious attention to economic issues such as food security, to respond quickly to sensitive issues raised on the Internet, to manage public mood. Quick resolution of problems by the government

strengthens the people's trust in the government and leaders. In addition, it requires a new approach and rapid performance from the media and all state bodies. As meeting the needs of the people in this information and rapid publication of articles on important issues, problems and the events of public interest, the activation of communication with the audience today demonstrates the unique development of the information industry.

<sup>17</sup> Wang Linlin (王淋淋). Government updates in the Internet era (网络时代的政府更新). Institute of Public Administration Studies (国家行政学院出版社). 2013. — page 178.





## **RHETORIC IN THE ENGLISH AND UZBEK LANGUAGES**

**Khushnuda Batirovna SAMIGOVA**  
**Farkhod Khabibullayevich ABDULLAYEV**

Speech culture and the art of public speaking are the issues that were conducted constantly and still supposed to be studied in the world linguistics. Human beings always have intended to speak expressively and impressively for ages. Therefore, these above mentioned topics are considered to be among the topical issues that have to be revealed and the existing researches have to be developed periodically.

The comparative study of rhetoric aspect of speech culture in the English and Uzbek languages is very important in increasing and developing learners' knowledge, skills and experience in using the linguistic means referring to these languages. It is too difficult to understand and to justify the specialists, especially the leaders and the heads who can not express their ideas independently and have not got fluency, eloquence and accuracy in speaking in their mother tongue.<sup>1</sup> Thus idea clarifies the importance of being aware of secrets of speech culture and the art of public speaking nowadays.

A number of research results including the followings related to rhetoric aspect were obtained in the world: the peculiarities of linguistic and stylistic means in developing and improving written speech and increasing communication effectiveness in dialogic rhetoric have been proven (Boston College), the linguistic peculiarities of paradox and promise in increasing speech efficiency were proved (Massachusetts University), the most frequently impacting factors on the formation of modern rhetoric in political processes were identified (The Novgorod State Institute), the gender and linguocultural peculiarities of dialogic rhetoric were proven (The Uzbekistan State World Languages University).

A number of researches including the following priority directions in the world linguistics

on studying rhetoric aspect of speech culture are being carried out: determining linguistic peculiarities of rhetoric at different language levels; improving bilingual and explanatory dictionaries referred to the terms in rhetoric; generally improving the measures in developing speech and communication culture; developing new innovation methods in improving peoples' oral and written speech activities; identifying the peculiarities of rhetoric according to the types of speech.

In linguistics a lot of works on rhetoric were carried out in different languages and remarkable researches by scientists can be considered as a great contribution to linguistics. For instance, A. Judith conducting dialogic rhetoric in English mainly concentrated on revealing the dialectical features of it. C. Patricia Foley studied the significance of permission in rhetoric on the basis of English speech patterns. M.M. Hincks focused on conducting the written speech in rhetoric aspect. L.M. Long, W.A.I. Paton and other scholars devoted their works to reveal other issues related to the English rhetoric<sup>2</sup>.

---

<sup>2</sup> Judith A. The Genre of Logic and Artifice: Dialectic, Rhetoric, and English Dialogues. – Dissertation for Achieving PhD. – Toronto, Toronto university, 1998. – 280 p.; Patricia C. Foley. Paradox and Promise in the Dialogue on Race: a Case Study Analysis of the Dialogues of the Springfield World Class City Commission. – Dissertation for Achieving PhD. – Massachusetts, Massachusetts University, 1999. – 200 p.; M.M. Hincks. Successful Dialogues: Systematic, Written, and Prominent Self-analysis in College Composition. – Dissertation for Achieving PhD. – Boston, Boston College, 2005. – 170 p.; Long L.M. Associative Rhetoric: Beyond Rhetorical Sensitivity and Individual Rhetoric. – Dissertation for Achieving PhD. – Georgia, University of Georgia, 1997. – 287 p.; Paton W.A.I. Current-Traditional Rhetoric Reexamined. – Dissertation for

---

<sup>1</sup> Каримов И.А. Баркамол авлод – Ўзбекистон тараққийининг пойдевори. Баркамол авлод орзуи. – Т.: Шарқ, 1997. – Б. 15.



In N.A. Kashey, G.M. Yarmarkina, Z.I. Kurtseva<sup>3</sup> and other scholars approached to rhetoric aspect from Russian point of view. Scholars such as V.O. Nemchenko, N.U. Georgeva<sup>4</sup> approached to this topic from teaching point of view.

The types of public speech and linguistic-stylistic means expressed in the orator's speech were studied in A.Kh. Arkhipova's work in Uzbek linguistics. D. Teshabaeva conducted the modern aspects of speech culture on the basis of mass media texts. Scholars such as H. Jalilov, H. Pasulov, S. Svirskiy, A.Y. Mikhnevich, I.A. Krivelev, N. Mahmudov worked out the issue connecting with teachers and lecturers' art of speaking. S. Inomkhujayev, A. Ahmedov, N. Bekmirzaev, H. Jalilov, Y. Mukhibov, E. Mukhibov's monographic works were devoted to reveal the basis of public speaking. The developing periods of the Eastern art of public speaking was described in S. Inomkhujayev's work. B. Omonov analyzed political speaking skills<sup>5</sup>.

---

Achieving PhD. – Michigan, Michigan University, 1990. – 267 p.

<sup>3</sup> Кашей Н.А. Современная риторика в социально-политическом взаимодействии. Дис. ...док. филол. наук. – Великий Новгород, НГУ, 2005. – 290 с.; Ярмакина Г.М. Обыденная риторика: просьба, приказ, предложение, убеждение, уговоры и способы их выражения в русской разговорной речи: Дис. ...канд. филол. наук. – Саратов: СГУ имени Н.Г. Чернышевского, 2001. – 180 с.; Курцева З.И. Коммуникативно-нравственный аспект риторического образования: Автореф. дис. ...канд. пед. наук. – Москва: МПГУ, 2002. – С. 70.

<sup>4</sup> Немченко В.О. Формування внутрішнього переконання судді в адміністративному процесі України: Автореф. дис. ...канд. юрид. наук. – Запоріжжя, ЗНУ, 2013. – 20 с.; Георгієва Н.Ю. Просодія переконування в англійському діалогічному мовленні: Автореф. дис. ...канд. філол. наук. – Одеса: ОНУ, 2005. – 21 с.

<sup>5</sup> Арипова А.Х. Нотиклик нутқининг лисоний-услугий воситалари: Филол. фан. номз. ...дис. – Тошкент: ЎзР ФА, Алишер Навоий номидаги Тил ва адабиёт институти, 2002. – 170 б.; Тешабоева Д.М. Оммавий ахборот воситалари тилининг нутқ маданияти аспектида тадқиқи (ЎзР ОАВ мисолида): Филол. фан. док. ...дис. автореф. – Тошкент: ЎзДЖТУ, 2012. – Б. 20-28; Жалилов Х. Ижтимоий фан ўқитувчиларининг нотиклик санъати. – Монография. Т.: Ўзбекистон, 1987. – 32 б.; Расулов Х., Свирский С. Лекторнинг нотиклик санъати – Монография. Т.: Ўзбекистон, 1978. – 39 б.; Кривелев И.А. Лекторнинг нотиклик санъати. – Монография. Т.: Ўзбекистон, 1980. – 15 б.; Михневич А.Е. Лекторнинг нотиклик санъати. –

The gender and linguocultural peculiarities of rhetoric, linguistic and extra linguistic factors of it on the basis of dialogic speech have not been studied in not kindred languages by foreign and Uzbek scholars yet. Thus, it will strengthen the necessity of a new research work on the dialogic rhetoric.

The thesis research was reflected in the scientific research plans of the Uzbekistan State World Languages University and was conducted within the framework of the scientific researches referred to the topic «The important issues of Linguoculture».

The aim of the research work is to conduct dialogic speech in the rhetoric aspect on the basis of English and Uzbek speech patterns and reveal national and common sides of these languages.

The tasks of the research work is to scientifically prove the fact that dialogic speech is considered to be a studying object of rhetoric;

determine linguistic and extra linguistic factors and prove common and differential sides of them;

prove the general and common sides of linguistic means referred to men and women's speech;

clarify the most frequently used topics and identify the usage frequency of linguistic means referred to them according to their usage in speech;

justify linguistic means expressing the national-cultural peculiarities in dialogic rhetoric;

identify linguistic units expressing positive and negative meaning in dialogic rhetoric of the English and Uzbek languages.

The object of the research is dialogic rhetoric in the English and Uzbek languages.

The subject of the research work is a comparative study of linguistic and extra linguistic means of dialogic rhetoric in the English and Uzbek languages, conducting gender and linguocultural peculiarities of it.

---

Монография. Т.: Ўзбекистон, 1979. – 44 б.; Махмудов Н. Ўқитувчи нутқ маданияти. – Т.: Алишер Навоий номидаги Ўзбекистон Миллий кутубхонаси, 2007. – Б. 20-157; Иномхўжаев С. Нотиклик санъати асослари. – Т.: Ўқитувчи, 1982. – Б. 5-124; Аҳмедов А. Нотиклик санъати. – Монография. Т.: Ўзбекистон, 1967. – 56 б.; Bekmirzaev N. Notqlik asoslari. – Т.: Yangi nashr, 2008. – 140 б.; Бекмирзаев Н. Нотик ва нутқ. – Т.: Наврўз, 2015. – Б. 17-39; Жалилов Х. Нотиклик санъати. – Монография. Т.: Ўзбекистон, 1976. – 77 б.; Мухибов Я., Мухибов Ё. Искусство публичного выступления. Риторика. – Т.: Ўқитувчи, 2011. – 173 б.; Иномхўжаев С. Ўтмиш шарқ нотиклиги. – Т.: Ўзбекистон, 1982. – 38 б.; Б. Омонов. Сиёсий етакчининг нотиклик маҳорати. – Монография. – Т.: Ўзбекистон, 2000. – 91 б.



Authenticity of the research results is defined by persuasiveness of conclusions, a concrete statement of a problem, an efficiency of approaches and methods applied in work, the fact that theoretical approaches applied within it received on actual linguistic materials and dictionaries, printed and electronic products issued on the recommendation of the responsible organizations. The relevance of the achieved results to the theoretical conception of this work, achieved novelties and defined new issues also define the authenticity of the research work.

The results of the research and scientific conclusions can be used in carrying out scientific researches in Comparative Linguistics, Translation Studies. The materials of the research can be in great use in defining the national-cultural peculiarities of the languages in Linguistics and Translation Studies. The scientific-theoretical conclusions of the thesis will also serve to further improvement of the teaching and educational process.

The practical value of the thesis is determined by the use of its conclusions in teaching the special courses and the aspects such as «The Basis of Speech Culture», «Stylistics», «Foreign Language (English)», «Uzbek Language».

There are four aspects of speech culture: normative, ethical, communicative<sup>6</sup> and rhetoric<sup>7</sup>. Each of the aspects is considered to have their specific features. Following a number of rules such as normative, the correctness, accuracy, purity, relevancy, logicity of speech and being aware of consistent patterns and secrets of etiquette of speech, public speaking and rhetoric can serve as a basis in possessing beneficial results during communication.

In linguistic dictionaries the word *rhetoric* is interpreted in the following way: «Rhetoric is the aspect that studies efficient and eloquent speech theoretically»<sup>8</sup>.

Ancient times orators expounded this word in this way: «*It is the art that teaches us to be aware of the ways in making people believe in a definite issue*» (Aristotle), «*It is the aspect that trains us to speak correctly*» (Quintilian). Russian scholars gave the following identifications to it: «*It is the art of speaking effectively, persuasively*» (M.V.

Lomonosov), «*It is the workmanship that knows how to impress others that can find the way to the heart of mankind, and can lead them towards a speaker's intentions, ambitions*» (N. Koshanskiy, M.M. Speranski)<sup>9</sup>.

Foreign scholars interpreted the term rhetoric in various versions: «*It is a persuasion, speaking correctly and the art of decorating a speech*» (V. Florescu), «*It is the theory of persuasive speech*» (C. Perelman, B. Franz, Geissner), «*The art that was formed on the basis of observation different speeches*» (De Marsais), «*The art of thinking carefully and cautiously in order to touch the feelings*» (Beckon)<sup>10</sup>.

From our point of view: «Rhetoric is an art of speaking expressively, meaningfully, effectively and it aims to have an effect on listeners, to direct them towards a speaker's intentions, to interest them in a certain issue, to persuade them to implement good jobs». We approve the definitions that describe rhetoric as *an art of persuasion and reassurance*, we accept them as the most relevant interpretations that were given to this term.

The term rhetoric is interpreted in two ways. Mainly rhetoric is referred to a subject that aims to study the basis of public speaking. It is also defined as an aspect that theoretically reveals any kind of expressive and impressive speech.

Before being formed as a school subject rhetoric passed through many historical periods. In 510 BC with the formation of democratic institutions in the Athens the art of speaking became a very important part of life, as well as in the public service branches. A group of teachers who were called *sophists* began to teach people to speak better and more expressively<sup>11</sup>. Their lessons were very expensive and sophists considered their knowledge as wisdom<sup>12</sup>. In Rome teachers and masters of rhetoric were the Greeks. The great masters of theoretical and practical rhetoric were Cicero and Quintilian, both of them carried the teaching process on the basis of Greek methods<sup>13</sup>.

<sup>6</sup> Тешабоева Д.М. Оммавий ахборот воситалари тилининг нутқ маданияти аспектида тадқиқи (ЎзР ОАВ мисолида): Филол. фан. док. ...дис. автореф. – Тошкент: ЎзДЖТУ, 2012. – Б. 24-36; Культура русской речи. Учебник для ВУЗов. – М.: Норма-Инфра, 2000. – С. 15.

<sup>7</sup> Пасечная И.Н. Культура речи (аспекты порождения высказывания). – Орск, ОГТИ, 2012. – С. 9-28.

<sup>8</sup> Ахманова О.С. Словарь лингвистических терминов. – М.: Советская энциклопедия, 1969. – С. 389.

<sup>9</sup> Габуния З., Башиева С. Риторика как часть традиционной культуры. – Нальчик, ЭЛЬФА, 1993. – С. 3-77.

<sup>10</sup> Тарасов Е.Ф. и другие. Речевое воздействие в сфере массовой коммуникации. – М.: Наука, 1990. – С. 15-21.

<sup>11</sup> Нерсесянц В.С. Сократ. – М.: Инфра – М – Норма, 1996. – С. 60.

<sup>12</sup> Введенская Л.А., Павлова Л.Г. Риторика и культура речи. – Ростов – на Дону: Феникс, 1998. – С. 223.

<sup>13</sup> Funk and Wagnalls New Encyclopedia. – USA: Funk and Wagnalls, 1976. V 22. – p. 252.



In many countries the rhetoric was said to exist in the 3 main spheres of life: in politics, in judicial system and in religion.

The traditional rhetoric had a great impact on the art of public speaking in Great Britain. That was a period in the Middle Ages when religious rhetoric was on the top of its popularity and political rhetoric had already lost its value. In England the most famous ancient religious rhetor (speaker) was John Henry Newman. Widely agitating religion he had a strong effect on the promotion of local religious standards<sup>14</sup>. Ancient popular religious orators such as Paul, John Chrysostom and Augustine used to speak to public. By the end of the XV century famous orators such as Savonarola, in the XVI century Martin Luther and John Calvin spoke to public<sup>15</sup>. In the XVIII century under the influence of the Latin and Greek literature the art of public speaking developed in England<sup>16</sup>. During the Renaissance rhetoric was in the height of popularity and became an important aspect in the spiritual and cultural life<sup>17</sup>. During this period political rhetoric was considered to be more important, people began to be interested in it constantly. In the XIX century (1832) the reformation of the laws led the art of public speaking to the further development. But in a short period of time it turned to be a simple political speech, it was considered to be quite a noncense<sup>18</sup>. By the 1920<sup>th</sup> the traditional rhetoric had lost its scientific significance and was taught only in the aspect of Stylistics<sup>19</sup>.

The Greek oratory was known as preaching (*voizlik*) in the East. Preaching was considered to be an art having a social importance that had a great connection with public speaking, scientific and political lectures, discussions, debates, agitation and propaganda. In ancient times in Eastern countries a king came out to public personally and spoke about the local policy, the international situation and other issues<sup>20</sup>. They used to speak on Fridays during

praying times, on national holidays Hayit and Navruz and on other days. They would also speak at the meetings to announce about wars that had broken out between countries. In the IX century this responsibility was given to special people who were called preachers (*voizlar*) and used to speak effectively, persuasively in a pleasant voice.

Islamic teaching system called *sufizm* aimed to lead a person toward the spiritual and ethical perfection and it also had a great impact in the development of rhetoric in Uzbekistan. Kozi Ishoniy (XV-XVI centuries) the author of the book «A Secret of a Word» from Fergana made a great contribution to the development of rhetoric. He was a master of human psychology; he could easily persuade, reassure people and win in any disputes and discussions<sup>21</sup>.

The East had its own great muslim scholars, religious leaders, writers and many other mature preachers. Khoja Muayyad Mehnagi, Mavlono Riyoziy, Hussain Voiz Koshifiy, Mavlono Muin Voiz Hisraviy, Bahauddin Valad, Jaloliddin Rumi, Mufti Ziyovuddinxon son of Ishan Bobohon, Abu Rayhon Beruniy, Muhammad Sodiq Qoshgariy, Abu Nasr Farobiy, Kaykovus, Zahiriddin Muhammad Bobur, Alisher Navoiy and others were great and famous statesmen with their lively, powerful speech at that time.

At the beginning of the 60<sup>th</sup> more attention was given to learn the norms of literary language. The traditional rhetoric had lost its scientific value and they began to teach it at higher educational institutions in the aspect «The Basis of Speech Culture». Historical rhetoric had its own methods of existence. A new life has brought to it new methods.

In the development period rhetoric was considered to be only related to three types of speech (political, judicial and religious), those were recognized to be the studying objects of rhetoric. However, later in some source materials informing about public speaking this point of view was rejected. For instance, G.Z. Apresyan and S. Inomxojev fulfilled the antique information with their point of views by adding political-social, academic, judicial, social-common, religious, mass media speeches to above mentioned 3 speeches<sup>22</sup>. A.Y. Mikhnevich added disputes to above mentioned ones<sup>23</sup>. This type of speech includes the speeches that are expressed at

<sup>14</sup> The Columbia Encyclopedia. – USA: Columbia University Press, 1993. – P.2091-2092.

<sup>15</sup> World Book Encyclopedia. – USA: World Book, 1994. V.14. – P. 819.

<sup>16</sup> Britannica Concise Encyclopedia. – USA: Encyclopedia Britannica, 2003. – P. 1034.

<sup>17</sup> Цицерон. Три трактата об ораторском искусстве. – М.: Наука, 1972. – С. 356; Габуния З., Башиева С. Риторика как часть традиционной культуры. – Нальчик, ЭЛЬФА, 1993. – С. 3

<sup>18</sup> Britannica Concise Encyclopedia. – USA: Encyclopedia Britannica, 2003. – P. 2091-2092.

<sup>19</sup> Гиро П. От риторики к стилистике// Новое в зарубежном лингвистике. – М.: Прогресс, 1980. – С. 35-40.

<sup>20</sup> Ўзбекистон Миллий энциклопедияси. 12 жилдли. – Т.: «Ўзбекистон миллий энциклопедияси» Давлат илмий нашриёти, 2001.

Ж. 2. – Б. 6; Апресян Г.З. Ораторское искусство. – М.: МУ, 1978. – С. 30; Жалилов Х. Нотиклик санъати. – Т.: Ўзбекистон, 1976. – Б. 13.

<sup>21</sup> Апресян Г.З. Ораторское искусство. – М.: МУ, 1978. – С. 30-31.

<sup>22</sup> Апресян Г.З. Ораторское искусство. – М.: МГУ, 1972. – С. 62-63; Иномхўжаев С. Нотиклик санъати асослари. – Т.: Ўқитувчи, 1982. – Б. 6.

<sup>23</sup> Михневич А.Е. Лекторнинг нотиклик санъати. – Т.: Ўзбекистон, 1979. – Б. 13.





meetings, dialogues, disputes, debates, symposiums, question-and-answer evenings, press conferences and in other situations.

In the World Encyclopedia on Philosophy we can find information confirming the fact that rhetoric exists in ordinary oral speech, in exchanging the ideas (the oral dialogues between two or more people), in transferring some information in a certain sequence (rumors), in speeches representing oral folk (telling tales, anecdotes, myths)<sup>24</sup>.

Among above mentioned speeches we focus on studying oral dialogues between two or more people in our research work.

Many scholars approved the idea that dialogic speech is considered to be the studying object of rhetoric.<sup>25</sup> Ancient or traditional rhetoric used to study only formal public speaking, but the modern one considers all forms of speech, as well as the dialogic speech as its conducting object.

L.A. Vvedenskaya, L.G. Pavlova divide dialogue based speeches into two: formal and informal<sup>26</sup>. Formal speeches include the speeches on a certain issue, on documentations, on agreement and office meeting speeches. Informal speeches are considered to be the most used speech. It is used among family members, in the streets, in the transports, in a friendly conversations between friends and closely familiar people. We focus on the second informal type of dialogues mentioned above.

Linguistic means belonging to different language levels and serving to increase speech efficiency are also determined in this article.

Pronouncing the last vowel of a word longer in Uzbek and stressing each word in the sentence and expressing it politely in English increases the efficiency of speech in both languages. By pronouncing the words *please* and *илтимос* longer and louder the persuasion is strengthened. Some consonant sounds are often omitted in Uzbek as the result of pronouncing the last vowel in a word longer (*берақо-о-о, келақо-о-о*), but in English this linguistic phenomenon is not used. Accurately and clearly expressed words, phrases expressed with love and care may have a positive impact on listeners in both languages. Stressing each word in English and each syllable separately in Uzbek increases speech efficiency. Using excessing sounds in these languages (*uh..., ums..., ahs..., er... / ҳм..., э...*), coughing and pausing decrease the quality of eloquency. By stressing addressing words in the sentence one can easily attract a listener's attention to himself/herself in both languages. Stressing not only a syllable and a word but the whole sentence or a text surely would increase the speech efficiency in both languages as well.

Suffix *-қуз*, second person singular expressing the meaning of respect, negative meaning forming suffix *-май*, interjections such as *-ми, -чи* are constantly used in Uzbek dialogic rhetoric. But in English this linguistic phenomenon is expressed by the usage of negative and interrogative forms of modal verbs in sentences (*could you, couldn't, will you, won't you*). Adding diminutive and affectionate suffixes to a person's name also has an impact on the expressiveness of speech (*Ann+ie / Жавлон+жон*) in both languages. Expressiveness is increased by adding to a listener's name the suffixes such as *-жон, -хон, -бек* that express the meaning of respect in Uzbek. But in English adding to a person's name words such as *Mr., Mrs., Miss* expressing the same meaning would increase speech efficiency. This linguistic phenomenon is interpreted with the fact that the Uzbek language is considered to be in a group of agglutinative languages and English is included into the analytical languages group. Thus in major cases suffixes are mainly added to a word in Uzbek, meanwhile in English this linguistic phenomenon is seldom used.

Adding diminutive and affectionate affixes, possessive pronoun of the first person singular to the words expressing relatives such as *ака, опа, ука* (brother, sister) in Uzbek as well as using them before names (*Ботир+жон укам, Опоқи+жон*) surely increases effectiveness of speech. The words of relatives in this language are even used to unfamiliar people, but in English they are only used to relatives (*auntie, daddy*).

<sup>24</sup> Грицанов А.А. Всемирная энциклопедия. Философия. – М.: Современный литератор, 2001. – С. 865.

<sup>25</sup> Франк Д. Семь грехов прагматики: тезисы о теории речевых актов, анализе речевого общения, лингвистике и риторике// Новое в зарубежной лингвистике. – Москва: Прогресс, 1986. – № 17. – С. 370; Рождественский Ю.В. Лекции по общему языкознанию. – М.: Высшая школа, 1990. – С. 70-74; Кривелев И.А. Лекторнинг нотиклик санъати. – Т.: Ўзбекистон, 1980. – Б. 5; Платон. Диалоги. – М.: Эксмо, 2007. – Т. 1. – С. 5-1220; Рождественский Ю.В. Теория риторики. – М.: Добросовесть, 1999. – С. 3-442; Азизян И.А. Диалог искусств Серебряного века. – М.: Прогресс-Традиция, 2001. – С. 5-387; Грицанов А.А. Всемирная энциклопедия. Философия. – М.: Современный литератор, 2001. – С. 865; Мартынова И.А. Основы риторики. – Санкт Петербург: Сова, 2002. – С. 188; Ипполитова Н.А, Князева О.Ю., Савова М.Р. Русский язык и культура речи. – М.: Проспект, 2009. – С. 370-387; [www.ahmerov.com/book](http://www.ahmerov.com/book); <http://stylistics.academic.ru>.

<sup>26</sup> Введенская Л.А., Павлова Л.Г. Риторика и культура речи. – Ростов – на Дону: Феникс, 2005. – С. 6-52.





In dialogic rhetoric personal pronouns have a significant role. Using the plural forms of the pronoun *you / siz* is positively approved in rhetoric aspect of both languages.

In researched languages any kind of word can be used as a basic word (word that can be a reason in impressing a person). Using the auxiliary verb *do* or the word *just* before the main verb in English, adding the adverbs and adjectives such as *жуда, қаттиқ, роса* to the verbs in Uzbek increases efficiency of speech. In Uzbek repeated words (*қани-қани, олинг-олинг, келинг-келинг*) have significance in speech expressiveness, but in English this linguistic phenomenon does not exist. Equivalents for this kind of words in English can be a word, a word combination or a phrase (such as *welcome, help yourself*). Using unnecessary words (such as *well, so, just / анақа, тавба, астағфуриллоҳ*) repeatedly in dialogic rhetoric in both languages decreases effectiveness of the communication.

In dialogic rhetoric except a word a word combination, a sentence and a text can also be used as a basic linguistic unit in persuading, involving, reassuring a person in a certain issue in both languages. In researched languages efficiency can be increased by different means in declarative, interrogative, imperative, exclamatory sentences, rhetoric questions and conditional subordinate clause. Stressing the addressing and introductory words in these languages one can strengthen the effectiveness of speech. Interrogative sentences are considered to be more effective during communication process rather than declarative sentences. Unlike the English the Uzbeks often use advising words in the texts while making an impact on a listener.

Relative words are mainly expressed in Uzbek (as *опоқижон, амакижон, укажон*) while words of respect in English (as *sir, Mrs., dear*) increase speech efficiency by stressing addressing words. This linguistic phenomenon depicts the differential sides of dialogic rhetoric in these languages.

The significance of stylistic devices such as metaphor, metonymy, epiphora, repetition, hyperboly, alliteration, inversion, paraphrase, gradation, antithesis, litote, epithet, ellipsis, oxymoron, simile in dialogic rhetoric are revealed and scientifically approved with the help of speech patterns in both languages.

For instance, **simile** is a stylistic device that expresses similarity and exaggerates the same quality of an object comparing to the second one. This linguistic phenomenon is based on the likeness between two objects or happenings<sup>27</sup>. It is expressed

by adding the conjunctions *like, as* in English and suffixes *-дек, -дай* are added to the part of speech such as noun and pronoun in Uzbek. As well as the words *эўё, каби сингари, монанд* are used in simile. For example:

*Alan blew the pipe. Robin then repeated Alan's music and corrected some parts of it. Then Alan began again. Robin used the same tune.*

«Enough!» he said. «You can play the pipes. Now we will try something else». He got up to fight... «Robin Oig», he said. «You are a great piper! You are much better than me. I think I am better with the sword than you. But if we fought, I could not kill a good piper like you.»

*The quarrel had now ended. All night they played and ate and drank<sup>28</sup>.*

Филҳол эрини ийдириш йўлини тутиб, унга илиқ муомалада амр берди:

– Барака топгур, ҳалиям бўлса кўғирчоқ одам опчиқиб ўрнатинг. Сиздан нима кетди? **Карнайчидан бир пуф дегандай гап-ку, ахир!** Бир сафар хўп деяқолинг?!..

Расул ака гапни кўпам чўзиб ўтирмай, унинг амрини вожиб қилишни афзал билди:

– Хўп, кўғирчоқ одамни шу бугуноқ кўндириб қўяман<sup>29</sup>.

In the former example the sentence *I could not kill a good piper like you* was used to persuade the listener to calm down. In the latter pattern the sentence *Карнайчидан бир пуф дегандай гап-ку, ахир* was used in persuading the listener.

All sounding means that are not excepted as linguistic units, and have a significant importance in transferring information to the members of communication are called *paraphonetic means*. For instance, pronouncing a sound in a very soft tone in dialogic rhetoric one can obtain a suspected results of communication. Here is the speech:

«Wormtail will get us drinks», said Snape. «I am not your servant!» he squeaked, avoiding Snape's eye. «Really? I was under the impression that the Dark Lord placed you here to assist me.» «To assist, yes – but not to make you drinks...» «I had no idea, Wormtail, that you were craving more dangerous assignments», said Snape silkily. «This can be easily arranged: I shall speak to the Dark Lord.» *Wormtail hesitated for a moment... within seconds*

Шомақсудов А., Расулов И., Кўнғуров Р. Рустамов Х. Ўзбек тили стилистикаси. – Т.: Ўқитувчи, 1983. – Б. 239.

<sup>28</sup> Stevenson R.L. Kidnapped. – England: Longman, 1993. – P. 84.

<sup>29</sup> Аббос Саид. Беш кунлик дунё. – Т.: Шарқ, 1996. – Б. 26.

<sup>27</sup> Ўзбек тилининг изоҳли луғати. 5 жилдли. – Т.: «Ўзбекистон миллий энциклопедияси» Давлат илмий нашриёти, 2008. Ж. 5. – Б. 185;



he was back, bearing a dusty bottle and three glasses upon a tray<sup>30</sup>.

– Тўйда сени Ёқуб кўрган экан, – деди йиғи аралаш онам. – Тегмасанг бўлмайди.

– Нега ахир? Ким экан мени мажбурлаб хотин қилиб оладиган?.. Мен тегмайман унга!

... Ёқуб кириб келди.

– Сиз... сиз..., – дея олдим титраб-қақшаб...

– Ўзингизни босинг, Латофатхон, – деди Ёқуб... – Қўрқманг, – дея **секин товушда юпата бошлади у мени...** – Сизни бир кўришдаёқ ёқтириб қолдим... Мана шу ҳовли-жойни сенинг номинга расмийлаштираман. Шу жой сеники! Тагинда машина, устаган жойингга олиб боради...

...охури шоҳона ҳаёт ҳақидаги ваъдалар таъсирида бўшашдим, Ёқубники бўлдим...<sup>31</sup>

Pronouncing sounds softly in a mandative tone, expressing phrases in a begging and pleasing tone are also approved in the rhetoric aspect of both languages. Unlike in English, adding vowel sounds such as -а, -е, -я, -ю to the end of the last word surely increases the persuasiveness of speech in the Uzbek language.

The importance of human gestures in speech efficiency was analysed in this paragraph. Both nations may caress a shoulder of a listener with love and care while persuading him to some kind of actions. The English crossing their forefinger and middle fingers try to reassure and persuade their listeners.

The Uzbeks putting their hands on their chest try to convince a listener. Persuasion by caressing or patting on a listeners' shoulder frequently is used by adult men and women. The Uzbeks move a forefinger from the upper part of a face down. This gesture means «shame on you» and in this way they try to stop a listener from doing some action. Hand gestures during praying for the sake of a listener are expressed differently by two nations (the English gather all fingers together and touch their forehead and shoulders. The Uzbeks opening their hands put them together in order to pray).

The English in many cases apply to strangers with a smile on their face while persuading them to give some information. Uzbek speaker's smiling while talking to a stranger and persuading him/her to some activity (especially women's smile) may lead a

listener to have improper thoughts about the partner during the conversation.

The pleading and pleasing expression in speaker's eyes is considered to be one of the motivating, persuading factors in dialogic rhetoric in both languages. This expression can lead the partner to change his views toward the aim of a speaker. The English speaker's straightly looking at a listener's eyes is well appreciated in dialogic rhetoric, meanwhile in the Uzbek rhetoric aspect it is not appreciated positively.

Different approaches of local and foreign scholars to the term *gender* are theoretically analyzed in this paragraph. From our point of view the linguistic term *gender* is a reflection of men and women's world of view, culture and etiquette in their speech and language. In this paragraph the linguistic means that have a significant role in decreasing effectiveness of women's speech are analyzed in English and Uzbek.

In both languages women achieve a speech efficiency by pleasing, asking politely (*Please, Geordie, just for me, Geordie / Ҳамида бону ёшли кўзларини Ҳумоюнга тикди. Йиғлаб илтижо қилди: «Бу қандай кўргулик?»*). They use repetition, exclamatory sentences in their speech (*will you enter... will you be there... Geordie... please, Geordie / ...мусулмонлар! Бу қандай кўргулик? Мен боламни хавф-хатарга қандай ташлаб кетгаймен, мусулмонлар!; Will you be there, Geordie? / Наҳотки Ҳиндистонни бутунлай тарк этсак? Please, Geordie! / Илтимос, асалим!*). Expressiveness is gradually increased in their speech (*You must win. You must beat that Weber. I shall wish it with all my heart! I want you to win, Geordie / ...менинг дилимда қанча орзулар бор эди... Зора ўғлимиз ҳам шу мамлакатга чин фарзандлик хизматини қилса. Наҳотки бу орзулар бари пуч чиқса!*).

Women of the both nations try to express their speech politely and softly, this way expressiveness in their speech is increased. In persuading they use terms of endearment, praising words (*Iaddie – йигитча, darling – азизам, you are very beautiful tonight – сиз бугун жуда ҳам гўзалсиз каби*). While using terms of endearment English women in major cases use noun phrases, Uzbek women use verbal phrases additional to noun phrases (such as *my love, sweet, honey / жоним, айланай, ўргилай*).

They often use paralinguistic means such as crying, pleasing («*Have a mercy on me*», *she said cring / Ҳамида бону ёшли кўзларини Ҳумоюнга тикди. Йиғлаб илтижо қилди...*).

They also achieve a speech efficiency by giving advice (*You must be very gentle, David. Now you must try to bring each other happiness. Marriage is full of difficulties, David / Болам, укаларингга*

<sup>30</sup> Rowling J.K. Harry Potter. – New York: Scholastic inc., 2005. – P. 24.

<sup>31</sup> Ибодинов А. «Латофат» дўконидаги қатл. – Т.: Шарқ, 2001. – Б. 106.



доим ибрат бўлгин, сен каттасан, уларни доимо тўғри йўлга бошлагин, жон болам. Мен энди кексайиб қолдим...). This linguistic phenomenon is mostly used in Uzbek women's speech. They make very long sentences while giving advice and express their speech in whole texts. They remind the patterns taken from narrated stories and the religious book Hadis (such as *Ҳадисда шундай дейилган...*, *Қуронда бундай деб ёзилган...*). Meanwhile the English women make shorter sentences, they just speak to the point.

In dialogic rhetoric praying for the sake of a listener is mostly used by Uzbek women (such as *Худо хайрларингизни берсин, умринг узоқ бўлеур, барака топ*). This linguistic phenomenon is mostly used in older women's speech. English women rarely use these kind of phrases (such as *God bless you*).

English women try to make an impact on men by being angry and irritable. They can use *Black English* and foul language (*Hell with it. The hell with them*). Meanwhile Uzbek women mostly use cursing in their speech (*Қирон келсин илоё, ўша немисларга! Тур ўрнингдан-е. Э, башаранг қурсин*).

Moreover the Uzbek women make their speech more efficient by using phrases such as “*одамлар, қўшнилар нима дейди?*” (What do other people, neighbours say about it?). This linguistic phenomenon is not used by English women, in these cases they can use the phrase *shame on you*.

The men of both nations possess speech efficiency by bequesting and promising (*that is my last will...! бу менинг сенга қилган васиятим, ёдинда бўлсин... ; I promise... / ваъда бераман...*). They avoid of being sly, try to speak honestly, give real facts in their speech, they remind about financial support to a listener. This way they have an impact on their listeners (*I will pay for it..., I will support you financially..., I will loan the money, you needn't worry about taking it, I will help you / Мен турибман буёғига..., мен тўлайман..., шу ишни қилсанг минг сўм бераман*).

In the relations between men and women the English men become too romantic; they can produce effect on women by singing a song or reading a poem («*Oh my love is like a red red rose, That is newly sprung in June: O my love is like the melody, That is sweetly played in tune!*»<sup>32</sup>). English men use a very wide range of their lexics while making women believe in their love (such as *you are my love, darling, I love you*). Though there are so many endearing words in Uzbek, Uzbek men are a little bit

timid in making their lover believe in the love. They don't speak openly about their love.

English men widely use pleasing sentences while talking to women. Uzbek men prefer to be a bit proud in this situation and they don't use linguistic units that have a pleasing meaning.

In persuading English men frequently remind their listeners to behave like an English gentleman (*It is not the way of a gentletman; you ought never to offer your dirty money to a Highland gentleman*), meanwhile Uzbek men persuade, reassure a listener by reminding the characters of Uzbek men such as being confident, courageous and speaking only once (*Эркак киши битта гапиради, йигитлик сўзим..., сен эркаксан, эркакка ўхшаб гапир*).

Uzbek men always take into consideration the opinions and the interests of people, neighbours around them and remind the importance of them in their speech (*Одамлар, эшитганлар нима дейди?*). This linguistic phenomenon is not used by English men.

In both languages religious words and phrases, wishing good wishes, praying for the sake of a listener, advising are used (*God bless you..., be healthy.../ умрингдан барака топ..., Аллоҳим ўз паноҳида асрасин..., доимо иноқ бўлинглар, бир-бирингизни қўллаб-қувватланглар...*). But this linguistic phenomenon is mainly used in Uzbek men's speech.

Different lifestyle, religion, culture and other factors that are related to these both nations reflect the existence of national gender peculiarities in dialogic rhetoric.

While persuading listeners speakers use *linguistic units referred to religion* in researched languages. In the West they consider the Bible to be one of the most powerful weapons in upbringing good natured human beings, in persuading them to trust in God, in making them believe in Jesus Christ<sup>33</sup>, meanwhile in the Eastern religion, especially Islam religion is accepted as one of the factors used to influence people's feelings psychologically. Both nations use the words *God / Худо* in sentences while reassuring their listeners. In Uzbek the word *Худо* has synonyms such as *Оллоҳ, яратган эгам, Тангри*. The English word *God* has the synonym word *Lord*. Usage of the words *Jesus Christ, Bible* in English and the words *дўзах, Қуръон, Ҳадис, жаннат, суннат* in Uzbek depicts the national peculiarities of dialogic rhetoric.

In dialogic rhetoric by *praying to the God for a listener's sake* speech efficiency is possessed. In these languages they use the words *God / Худо (God save you, God bless you / Худо сени ўз паноҳида асрасин, Худо сени яллақасин)*. However,

<sup>32</sup> Walker D. Geordie. – UK: Nelson, 1992. – P. 63.

<sup>33</sup> <http://www.creationtips.com/influence.html> библия





according to the religious beliefs of the English, the name of the Holy Father is used in praying (*our Father bless you*). But in Uzbek they use the phrases referring to the personal matters and the life of a listener (*бола-чақангнинг роҳатини кўр, орзу-ниятларингга ет, яхши жойлардан ато қилсин*). Thus the phenomenon indicates the national sides of dialogic rhetoric in researched languages. During praying for a listener's sake the Uzbeks use very long sentences, meanwhile the English make short sentences.

Speakers remind a listener about the rules and laws of the country in dialogic rhetoric. They persuade a listener or stop him from doing some actions by using the phrases *you have no right, I will call the police / ҳаққингиз йўқ, полиция чақираман* in both languages. But in Uzbek to remind about the police is rarely used, because this nation is considered to be too shameful, compromise. Disputes usually end on the basis of agreement and compromising.

In the dialogic rhetoric of the both languages *bequeathing* is used. These nations always consider that the will of a dying person must be fulfilled. While bequeathing the English don't make their speech long and they only speak to the point. But the Uzbek make very complicated and long sentences during bequeathing. They pray for the sake of listeners, wish good things, and give advice to them while bequeathing.

*Advising* is also accepted as a factor that is used to have an impact on people in both languages. In English they always remind a listener not to forget about behaving themselves as English ladies and gentlemen (such as *Gentlemen do not insult their friends*). In Uzbek they constantly remind the listeners to follow the rules of etiquette and also remind the ideas about implementing the duties referred to children, parents, family (such as *Буғун шаҳарга тушиб, онанг қабрини зиёрат қилиб чиқ, болам. Сира-сира кечиктиришга ҳаққинг йўқ, бурч бу. Фарзандсан, ота-онангни тирикликларидан рози қил, вафот этганларидан кейин ҳам бепарво қолма*). In English they use shorter sentences and phrases, meanwhile the Uzbeks use too long sentences. In Uzbek, advising is constantly used rather than in English in reassuring and persuading a listener.

In the researched languages *swearing* on the name of God is used to increase speech eloquence (*Lord knows, I swear by almighty God / тегсам, Худо урсин, Худо ҳаққи*). The English trusting Christianity swear using the following phrases: *I swear by Jupiter, by Jove! I swear by almighty God! I swear by all that is holy, by the welkin! Honest to*

*God! Honest to goodness*.<sup>34</sup> The Uzbeks whose belief is Islam use the following phrases referred to this religion: *каломупло урсин, Қуръон урсин, Худо урсин*. They also express the exaggeration while swearing (*ёлғон айтсам ёрилиб ўлай*)<sup>35</sup>, meanwhile the English may swear on mother's grave (*I swear to that on my mother's grave...*)<sup>36</sup>. Thus phenomenon shows national peculiarities of dialogic rhetoric in both languages.

In researched languages linguistic phenomenon *promising* has significant role in speech eloquence. Speech patterns such as *I will take the moon for you – ойни олиб бераман, I will never be Romeo – отимни бошқа қўяман* are equivalent phrases in promising in these languages. The usage of the English phrase *words of a gentleman* and the Uzbek phrase *йигитлик сўзим* in speech while promising depicts the national peculiarities of dialogic rhetoric.

In dialogic rhetoric by *asking politely or pleasing* a listener, one can easily persuade him. Pronouncing the word *please* in English and the word *илтимос* in Uzbek longer increases speech efficiency. Using the words expressing respect (such as *madam, sir*) before listener's names, the modal verbs in interrogative form make speech more efficient in English. Adding suffix *-жон* to the words expressing relatives and to a listener's name and pronouncing them in pleading and pleasing tone strengthens the speech efficiency (such as *жон амаки, жон Алишер*).

In dialogic rhetoric reminding a certain amount of national currency in speech (in English the words *dollar, pound* and *sterling*, in Uzbek the words *dollar* and *sum*), as well as using a comparative forms of adjectives such as *many* and *much / кўп* increases effectiveness of speech in conducting languages. In this situation speakers *offer a listener financial support*.

Reminding *food names* to a listener also increases speech efficiency in both languages. For instance, food and drinks such as *fish, beer, pudding* in English, *pilov, hot black tea* in Uzbek are some of them (*You better eat the fish anyway – from head to tail. I have heard this math test is really hard, and our brains need all the help they can get.*)<sup>37</sup> *Бўлмаса, бизникига кетдик. Битта яхши қўлбола ош*

<sup>34</sup> ru/dictionary/english\_russian/swear.html

<sup>35</sup> Сафаров Н. Наврўз. – Т.: Ғафур Ғулوم номидаги Адабиёт ва санъат нашриёти, 1977. – Б. 116.

<sup>36</sup> Macleod H. Mind Over Mussels. – Charlotte town: The Acorn Press, 2011. – P. 136.

<sup>37</sup> Collis H. 101 American Superstitions. – USA, Passport Books, 1998. – P. 46.



қилдираман, чой-пой ичамиз, қани-қани кетдик<sup>38</sup>).

They use *endorsing and approving phrases* in dialogic rhetoric. In both languages they use encouraging phrases that lead a partner to be brave and to be strong (*what are you afraid of; don't be afraid of / қўрқма, нимадан қўрқасан? Мен борман-ку ёнингда*). In Uzbek while endorsing they constantly use national proverbs too (*Билмаганин орланмай сўраган олим, орланиб сўрамаган ўзига золим*).

In dialogic rhetoric the phrases like *What will people around say about it?* are mainly expressed in the Uzbek language. As it is known the concept *shame* is considered to be the most serious factor in Uzbek culture. In this language the following phrases are very often used: *What will the neighbors say? What will the people say? What a shame?* In the West people used to living on the basis of individualistic theory, meanwhile in the East a team, a group and a collective work is preferred. They used to taking people's ideas and point of views into consideration. These kind of factors made an impact on the formation of the above mentioned linguistic phenomenon in dialogic rhetoric.

With the help of speech one can *make a listener feel sorry* for him in the English and Uzbek rhetoric aspect. In this case speakers pretend to be poor and tell about the situation they occurred to be. Paralinguistic means such as crying can be noticed in their behavior. Unlike in English, in Uzbek while making a listener feel sorry speakers may wish him the best wishes in long phrases and pray for the sake of him.

For the sake of nobility a light cheating is often approved in dialogic rhetoric. Linguistic phenomenon euphemism is also well appreciated in dialogic rhetoric. This linguistic phenomenon is closely connected with the concept *respect* in both languages, meanwhile it is also closely related to the concept *shame* in the Uzbek language.

*Terms of endearment* also serve to increase efficiency of speech in dialogic rhetoric. The equivalent phrases in both languages with the same meaning are used while caressing (such as *honey – асалим, dear – азирум*). But the words and phrases such as *my young lady, my gallant gentleman* in English, *акажон, опоқижон, амакижон* in Uzbek that are used while caressing depict the national peculiarities of dialogic rhetoric. As well as the suffixes are constantly added to the words of caressing in Uzbek, but in English this linguistic phenomenon is expressed by combining possessive pronoun of the first person singular to a term of endearment or a word (such as *my sweet, my*

*sweetheart, my love / жон+им, дўмбоқ+қина+м, тойчоғ+им*). Unlike in English, in Uzbek they use linguistic means formed on the verbal phrases while endearing (*гиргиттонинг бўлай, ўргилиб кетай*).

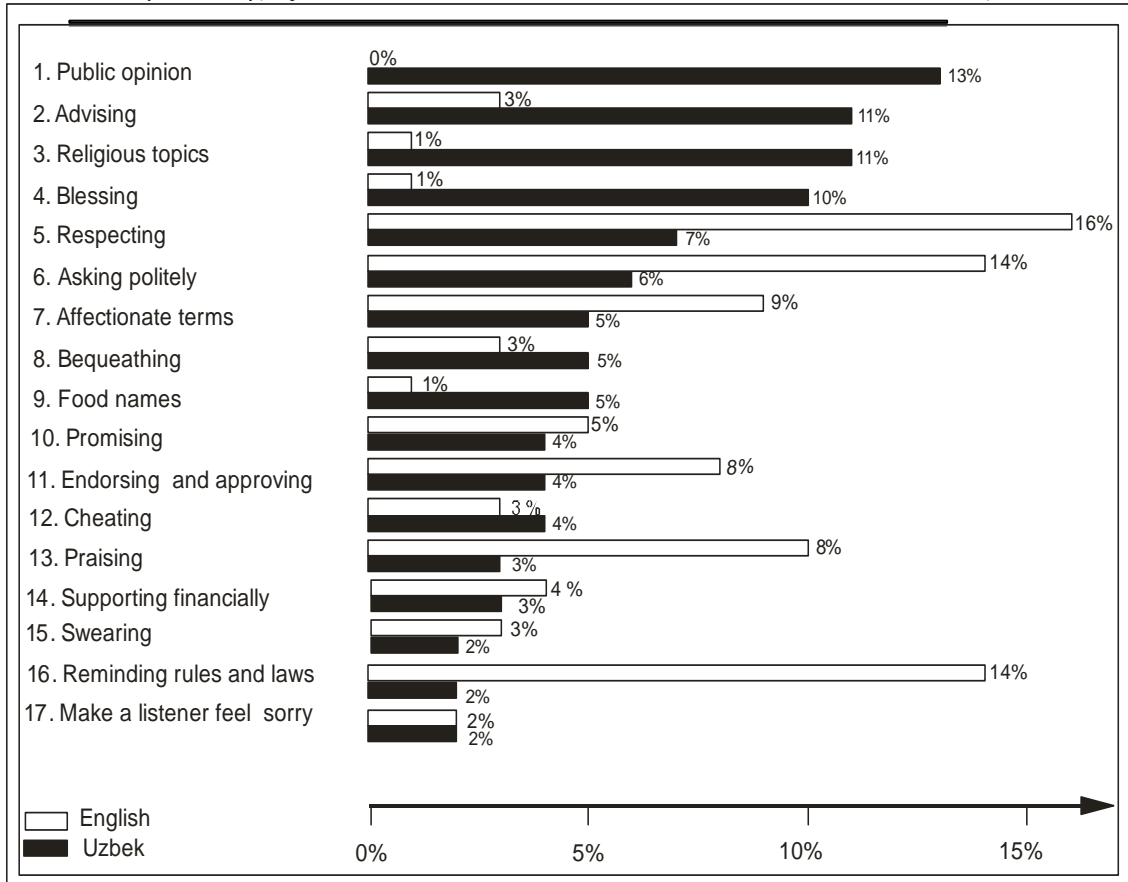
Linguistic units expressing *respect* are also well appreciated in dialogic rhetoric. In English this kind of linguistic units are used before the personal names, in Uzbek this linguistic phenomenon is expressed by adding suffixes to the end of personal names (*Mrs. Brown / Бобур+жон*). In Uzbek suffixes are also added to the words with the meaning of relativeness (*дада+жон, ойим+лар*) and in this case these words express the meaning of respect. The usage of modal verbs and the word *please* in English expresses the meaning of respect (*You will, won't you? / Will you eat your food? If you please...*). The personal pronoun as *you / сиз* in both languages serve to increase speech efficiency.

Linguistic units expressing *praise* are also used in dialogic rhetoric of both languages. For instance, phrases such as *you have nice eyes – кўзларингиз чиройли экан, you have beautiful hair – сочларингиз жуда чиройли экан, you look very smart in this suit – костюм сизга жуда ярашибди* are used in praising. Frankly appreciating the achievements, positive sides of a listener, praising him, using polite words and phrases surely would guarantee a good communication result. Praising words serve for the same objectives in these researched languages.

On the basis of research materials analysis we present the following picture that depicts the usage frequency of linguistic means in dialogic rhetoric (see picture 4.1):

<sup>38</sup> Исmoil Мухаммад. Баҳорнинг энг сўнгги лоласи. – Т.: O'zbekiston, 2006. – Б. 103.





**Picture 4.1. The usage frequency of linguistic means referring to the English and Uzbek dialogic rhetoric**

The above given picture shows that according to the usage frequency in speech the linguistic means that express respect (16%), pleasing (14%) and human rights (14%) possess the highest level in English. The linguistic means referred to the praying for the sake of a listener (1%), public opinions (0%) and religious topics (1%) possess the lowest levels.

The linguistic means that are referred to public opinion (13%), religious topics (11%), advising (11%), praying for the sake of a listener (10%) are accepted the most used means according to the usage frequency in Uzbek speech. The linguistic means that express swearing (2%) and human rights (2%) are considered to possess the lowest level.

The linguistic units that have a positive meaning are meant to be the units that are expressed on the basis of speech etiquette norms, these linguistic units (referring to endearing, praise, respect, pleasing) have been analyzed in the above given chapters. The linguistic units that express negative meaning are meant to be those units that express opposite meaning to the term politeness and kindness. According to the aim of speech the linguistic units that have a negative meaning are used in dialogic rhetoric. This type of rhetoric is called

*black rhetorics*<sup>39</sup>. In this type of rhetoric speakers use all possible ways, strategies, opportunities to achieve the goal of speech. Language norms are often violated in these cases. For instance, speakers may swear, frighten, threaten, curse, say insulting words to a listener (such as *Where are you? Come out of there! You little thieving rascal! / Goddamn your eyes, I will show you. Come on, let's go to the bridge. / For pity's sake, will you shut that mouth of yours and stop your prattling. / Борсанг, оқ сутимни кўкка созураман. Ўлсам гўримда тик тураман! / Ғирт сурбет экансан-ку! Нима бошқа ҳеч нарса калланга келмадими? Йўқол кўзимдан, аблаҳ*). This way a speaker tries to persuade a communicant to implement some actions. Mainly English and Uzbek men may swear their listeners while speaking. English women also constantly swear during their speech, meanwhile Uzbek women curse while persuading a person.

<sup>39</sup> Бредемайер К. Черная риторика: Власть и магия слова. – М.: Альпина Бизнес Букс, 2005. — 224 с.; [www.dr-bredemeier.de/black-rhetoric/](http://www.dr-bredemeier.de/black-rhetoric/); [www.jstor.org/stable/2783854](http://www.jstor.org/stable/2783854)



On the basis of the research analysis we come to the following conclusions:

In the West the art of speaking was initially formed from the speeches of sophists (teachers), but in the East it began from the speeches of preachers (people reading a king's verdict to public). Rhetoric has historical development stages, it is considered to change constantly.

Though rhetoric is interpreted as public speech, any kind of speech, including dialogic speech can be a studying object of rhetoric.

As rhetoric studies the ways of achieving speech efficiency, it depicts the means that serve to increase the efficiency of the English and Uzbek dialogic speech. In Uzbek in majority cases suffixes are added to the words in achieving speech efficiency but in English this linguistic phenomenon is expressed by adding certain words to another word. In English the words expressing respect, in Uzbek the words with relative meaning are mainly used.

Expression of stylistic devices has a significant role in dialogic rhetoric. Stylistic devices such as metonymy, anaphora, epiphora, inversion, paraphrase, hyperboly, ellipsis, gradation, antithesis and other stylistic devices, phraseological units are used in speech according to the aim of speech in both languages.

In the dialogic rhetoric parophonetic and parakinetic means play significant role in increasing speech efficiency. There are national and common features in their usage in researched languages.

In dialogic rhetoric there are different and common sides in English and Uzbek men and women's speech. The impact of western and eastern culture on forming these languages is reflected on dialogic rhetoric too.

Praying for the sake of a listener, bequeathing, advising, swearing, promising, pleasing, reminding about financial support and names of dishes, endorsing, reminding the laws, rules and peoples opinion, making people feel sorry, telling lies, caressing, respecting, praising, speaking on religious topics are considered to be the most frequently used topics in dialogic rhetoric. The usage frequency of the linguistic means referred to these topics in the researched languages differ from each other.

In the dialogic rhetoric of both languages linguistic means that express negative meaning are used in foul language, while insulting, cursing, frightening, threatening. English speaking women in majority cases use foul language, in Uzbek women's speech cursing is constantly expressed.

Variety of the following factors such as living conditions, geographic location, history, religious beliefs, culture, customs and traditions, national values, national character, national food, educational and upbringing basic principles, internal rules and laws of the area they live in and other factors are

considered to be the main reasons for existence of national peculiarities of dialogic rhetoric in both languages. As well as it depends on how these two nations interpret the concept *culture*. This phenomenon approves once again the existence of connection between language and culture.

In different language systems dialogic rhetoric has its gender, linguocultural peculiarities, both linguistic and nonlinguistic means are expressed in it. From this point of view gender, linguocultural peculiarities, linguistic and nonlinguistic means can be comparatively conducted in kindered and not kindered languages in translation studies, ethnolinguistics and comparative linguistics.

Rhetoric is a historic category. Periodical changings reflect on it. Rhetoric changes and forms periodically. The developing process of it has significant sides in the various cultural systems. From this point of view etymological peculiarities of rhetoric can be comparatively researched in different languages.

Rhetoric is a social phenomenon, it has its significant peculiarities in different social groups and conditions. This demands implementation of comparative research of it in different language systems from sociolinguistic point of view.

All kind of speeches can be a studying object of rhetoric. From this point of view political, military, religious and other types of private rhetoric can be researched in kindered and not kindered languages.



# THEORETICAL AND ECONOMIC PREREQUISITES FOR THE DEVELOPMENT OF REGIONAL INDUSTRIAL CLUSTERS IN THE ECONOMY OF THE REPUBLIC OF UZBEKISTAN

**Khankeldieva Guzal Sherovna**

*Professor of the Ferghana Politechnical Institute, Dsc.150100, Ferghana street 86, Ferghana city,  
Uzbekistan*

Article DOI: <https://doi.org/10.36713/epra4855>

## ABSTRACT

*The article focuses on the theoretical foundations of the development of regional industrial clusters, as well as identifies economic aspects of improving the activities of regional clusters in strategically important sectors of the economy of the Republic of Uzbekistan. As the examples of successful clusters show, the inclusion of medium and small enterprises in them is necessary to increase the flexibility and speed of the cluster's response to external changes, thereby increasing its competitiveness. The development of the innovation environment and institutions of network interaction is also a mandatory step in the formation of clusters.*

**KEY WORDS:** *cluster, cluster classification, industry, regional cluster, modernization, synergy effect, innovation, innovation cluster, production efficiency, investment resources, public-private partnership.*

## INTRODUCTION

At the present stage of industrial development in the Republic of Uzbekistan, an important role is played by the development of new forms of integration associations between enterprises of the dominant sectors of the economy. Innovative regional clusters are one of the promising forms of integration associations that contribute to the accelerated modernization of the region's economy. In the conditions of modernization of economic relations, the content of such forms of integration is expanding, which is the reason for new scientific research in this direction.

Currently, the concept of "regional cluster" is one of the most widely discussed in the economic literature abroad. In terms of sustainable development of economy of the Republic of Uzbekistan, the task is to find effective organizational and economic development of key industries in the region.

The essence of the cluster approach is that clusters represent geographically localized chains of independent organizations with intensive vertical and horizontal connections, which gives a synergistic effect [1].

## LITERATURE REVIEW

The American economist M. Porter made a significant contribution to the development of cluster theory. He considered a cluster as a group of geographically adjacent interconnected companies and related organizations operating in a certain area, characterized by common activities and complementary to each other [2].

The concept of "cluster" was introduced to Economics by Professor M. Porter of the Harvard business school, who defined a cluster as a set of geographically concentrated interconnected enterprises, specialized suppliers, financial and consulting enterprises, research and educational organizations that compete.

The definition of M.V. Beshpalov is considered the most popular among authors in the field of regional studies. According to its definition, a cluster is a Union of entrepreneurs whose members are linked by agreements on strategic interaction.

E.V. Kurkudinova considers the cluster as [4]:

- Regionally limited forms of economic activity within related sectors;



- Vertical production chains;
- Aggregation of industrial entrepreneurs at a high level.

## DISCUSSION

The review of theoretical works allowed us to conclude that one of the problems of practical use of the cluster concept is the lack of a unified approach to the conceptual apparatus, including the definition of a regional innovation cluster and types of innovative cluster effects.

Cluster effects are defined as the impact of participation in clusters on various output indicators of the firm and the cluster as a whole. In our study, we will focus on effects that describe the impact associated with cluster participation on the organization's performance, innovation activity, and competitiveness, i.e., innovative cluster effects [5, 6, 7].

We have formulated a working definition of a regional innovation cluster based on the theory of industrial agglomeration, taking into account the peculiarities of cluster formation, as well as the innovative activity of participants: a group of enterprises of various types competing for products, factors of production and markets located on the territory of one region, and characterized by: increased innovation (new products, technologies, business processes) and close interaction with knowledge sources.

The analysis of theoretical and empirical research has allowed us to identify the following types of innovative cluster effects [8, 9, 10, 11, 12, 13]:

- effect of agglomeration. The benefits that firms derive from co-location within a specific territory include economies of scale, equalization of transport and logistics costs, reduction of barriers to the exchange of knowledge, ideas and management practices, and simplified access to unique assets.

- learning effect. Close cooperation, exchange of information and knowledge within the network of cluster participants (firms, research organizations, universities, and others), lead to an increase in the level of knowledge of all participants. In innovation clusters, continuous learning processes are enhanced, creating positive externalities in the management and technological spheres.

- effect of cooperative competition. In an economy characterized by extensive networks of enterprises working simultaneously in cooperation and competition with each other, there are areas where competing producers can cooperate. These include, for example, lobbying, trade shows and fairs, specialized investments in infrastructure and training.

In contrast to theory, in practice it is quite problematic to separate one effect from another - in

developed innovation clusters; they may overlap and complement each other. The simultaneous influence of all components of innovative cluster effects leads to the emergence of synergy: firms participating in clusters are more motivated to create new products and firms than single enterprises, which leads to an increase in the innovative activity of all participants. Introduction of an approach to the study of regional innovation clusters that combines quantitative and qualitative analysis based on mezo-and micro-level.

When developing an approach, it is necessary to limit the scope of analysis of innovation clusters. First, we take into account innovation clusters where businesses may not have technological connections. Technologically linked chains are considered only as a part of an innovation cluster. Firms within the latter can use the full range of relationships: be members of the same business associations, collaborate with the same educational institutions, and demand the same innovative infrastructure. Secondly, the object of the study is not a single regional intersectoral innovation cluster with clearly defined borders, but a firm, and the probability of its participation in the cluster is estimated. We analyze enterprises that have a certain set of properties - location in the neighborhood, interaction with other market participants, innovation, which are more or less likely to be members of various innovation clusters in the region.

Our proposed 3-level approach can be presented as follows.

The first level is the study of conditions and opportunities for the formation of innovation clusters based on regional statistics. The study examines the regional environment, assesses the availability of competitive industries and necessary resources, the degree of diversification of the production structure, the degree of innovation activity of enterprises, and the infrastructure security of business in the broad sense of the word. If the results show that there are conditions for the development of clusters in the region, the next step is to search for those types of activities that have signs of clustering and the potential to increase innovation activity.

The second level is the identification of potential industry innovation clusters based on the assessment of localization and specialization coefficients that characterize the concentration of firms and employees in a particular sector of the region's economy. However, these indicators do not take into account cooperation between firms; they do not fully reflect the specifics of such a phenomenon as a cluster. Thus, for further analysis and evaluation of innovative cluster effects, it is necessary to move to the micro level, which allows not only to track the interaction within the cluster between organizations of various types of activities, but also to assess the factors that affect the probability of a firm's participation in clusters.



The third level is a quantitative assessment of innovative cluster effects and qualitative characteristics of cooperation based on micro-level data. In this case, a combination of quantitative and qualitative analysis methods is used. At the first stage, using econometric modeling, the hypothesis is tested that enterprises get competitive advantages from the effects of close placement and interaction and competition, that is, from innovative cluster effects. This stage, in turn, is divided into three consecutive steps:

Step 1. Identification of participants in innovation clusters;

Step 2. Assessment of the innovation cluster effects;

Step 1. Identification of factors that affect the probability of entering of the firm into innovation clusters.

The goal of the second stage, based on the results of in - depth interviews with participants of innovation clusters, is to detect additional factors that cannot be identified during the statistical

analyses. Thus, we include in the study those cluster agents with which the firm has no obvious technological connections.

Clusters have some key features. They cover the integration of scientific, educational and industrial potential of the region, has a high level of territorial concentration of cluster participants, which ensure the emergency of a synergistic effect in the modernization of industrial potential and innovative development of enterprises. In addition, clusters are characterized by the presence of systemically developing relationships and cooperation between cluster members. High innovative activity of cluster members allows us to constantly improve the competitive advantages of cluster members. Combining companies in clusters gives an advantage in reducing barriers to innovation, stimulating the development of the regional economy, improving the trade balance of the region, increasing employment and generally improving the competitiveness of the regional economy [14, 15].

**Table 1**  
**Types of cluster classification**

Classification parameters	Type of cluster
By the type of dominant relationships	horizontal, vertical; industrial, spatial
According to the degree of specialization /diversification	specialized, lateral, compositive, conglomerative
On the basis of availability of geographical concentration	urban, regional, national, cross-border; virtual (spatial proximity is not required)
By the source of induction	artificially stimulated; evolutionary (spontaneous)
By level of industrial coverage	micro-level (inter-company relationships); mezo-level (separate industry and intersectoral relationships); macro-level (considering the economy of the territory as a complex of intersectoral relationships);
By the nature of the main resource	based on trade; based on knowledge
On the stage of the life cycle	agglomeration; emerging; developing; mature; transforming
For the internal dynamics / efficiency	desirable; politically dependent; potential; latent; working
By type of distribution of market power	asymmetric; symmetric
By the nature of the participants	clusters of small companies and clusters with the presence of large businesses; clusters of local companies and clusters involving third-party firms; clusters of private companies; clusters with the presence of state organizations
By accessority	tradable; resource, local; high and low-income





By the degree of international embeddedness	third-party companies satisfy internal demand; third-party companies satisfy external demand
---	---

An important feature of a cluster that distinguishes it from other forms of business coordination is its location on a compact territory, which leads to an agglomeration effect. Production integration, supplemented by territorial proximity of enterprises and organizations participating in the cluster, generate a coordination mechanism for joint action that contributes to positive external effects from the close proximity of a large number of firms specializing in a particular field, closely connected through business and personal contacts to create opportunities for flexible response to changing consumer demands, to create conditions for the integration of institutions of higher education, business and science.

The economic effect of clusters is to increase labor productivity, reduce production costs, facilitate access to a new market, stimulate new companies, develop innovative potential, etc.

Regional industrial clusters are characterized by a high degree of implementation of innovative resources by reducing operating costs and transport costs of cluster participants due to the concentration of the industry enterprise in one territory. Minimizing investment risks by distributing them among cluster members also contributes to this process. In this regard, clusters stimulate innovation through the exchange of know-how, qualified personnel, and interaction with educational institutions. In addition, clustering contributes to the commercialization of knowledge by stimulating the creation of new companies, the ability to quickly test innovative products and services on the market.

One of the main features of the cluster is the presence of a set of associated positive effects that form their comparative advantages, such as the production scale effect, the coverage effect, the synergy effect and the multiplier effect [16].

The basis of the production scale effect is the presence of a core of innovation activity in the face of one of the cluster firms.

The optimal combination of elements of the cluster system creates a synergy effect, which increases the quality of products and improves the efficiency of interaction between the successful clusters. The essence of the effect is that a new economic structure that appears when merging enterprises can use a synergistic effect, while the result of such an Association exceeds the sum of the results of the activities of separate enterprises. However, here each participant retains its independence and fights to increase its own competitive advantages within the cluster, which generally contributes to the elimination of inefficient forms of enterprises.

With the simultaneous effect of scale,

coverage and synergy, non-profit cluster members can overcome the lower margin of profitability with the help of specialization, which provides increased productivity and reduced cost of production. This way, businesses that are part of the cluster get additional competitive opportunities.

The multiplicative effect of a cluster is influenced not only by the economic, but also by the geographical location of the region, which determines the degree of its economic isolation or openness, as well as the development and stability of the regional economy, which is largely provided by successfully functioning regional clusters. The ability of regional enterprises to produce competitive products that are in high demand not only in the region itself, but also outside it, determines a fairly high level of the multiplier effect.

In addition to the multiplier effect for cluster members, the multiplier effect also occurs for enterprises in related industries and supporting industries that form the cluster infrastructure. This is primarily due to the territorial proximity of enterprises to key cluster participants, the growth of investment attractiveness of the cluster, and the activation of innovation processes. Thus, attracting investment to clusters contributes to the emergence of a multiplicative effect of economic development in the entire region.

## CONCLUSIONS

Along with the activation of innovation processes in the region, clustering of the region's industry creates additional opportunities for sustainable development of the region. This will be due to the following circumstances:

1. Clusters, acting as an important factor in the formation and dissemination of industrial knowledge and skills through joint exchange of experience and joint training, contribute to the formation of sustainable innovation in the "learning region". The formation and use of industrial knowledge, skills and innovations are the most important factors of the region's competitiveness in the context of a globalized economy and the transition of the country's economy to a knowledge-based economy.

Cluster members take benefit from technology exchanges with large foreign corporations and local industrial equipment suppliers by reducing transaction costs, providing a high degree of flexibility in technology transfer, and effectively controlling the results of operations. In addition, many large foreign companies prefer face-to-face contact with local businesses, as technology exchange is a matter of trust.



The role of social relations in the region is also important for the formation of industrial knowledge. These social interactions arise from the historical and cultural characteristics of the region, which include: common standards and values, forms of interaction between subjects, specific forms of innovation within the cluster, and trust. Therefore, at the regional level, clusters provide a wide range of positive externalities or an innovative push, through the use of the region's available resources, its educational and research potential, and the cluster's communication network.

2. Clusters create conditions for accelerated modernization of local small enterprises. One of the main goals of sustainable regional development is to find reserves for growth of gross value added in the region. In recent decades, integration into the global production network has been a factor in increasing value added. The modernization of local small and medium-sized enterprises implies a process by which economic entities move from low-profit to relatively high-profit activities.

Regional industrial clusters provide small firms with a high degree of specialization in servicing specific industrial segments, as this facilitates access to the capital of an industrial enterprise, as well as an active exchange of ideas and transfer of knowledge from specialists to entrepreneurs starting their own business.

Modernization will mainly be achieved by improving the economic performance of small enterprises, updating production processes, improving product quality, switching to more profitable activities in the value chain, as well as innovation, technology, design and marketing.

Modernization in creating a value chain in production networks has a positive impact. However, such an upgrade always leads to wins and losses among companies and employees, and the profit generated from the increase in value through the upgrade processes is often distributed very unevenly. In addition, such benefits are not provided to the firm's employees in the form of higher wages, greater job security, or improved working conditions.

Modernization of small enterprises allows the implementation of a long-term development strategy, increased tax payments, environmental protection, health and safety of the region's population. This concept takes into account various forms of social modernization and environmental improvement, as well as the economic modernization of local small enterprises.

3. Clustering of the region's industry allows regional authorities to move from supporting specific enterprises to providing systematic support to target groups. Systematic support of target groups gives a multiplier effect to the development of the regional economy, which provides a qualitative leap in the innovative development of the region. State support

for cluster enterprises also reduces barriers to innovation, encourages the development of the regional economy, improves the trade balance of the region, promotes the use of various sources of technological knowledge and connections, and increases the competitiveness of the regional economy or the country as a whole.

4. Clustering improves the exchange of information between potential cluster participants. The cluster formation process is based on the exchange of information about needs, equipment and technology between industries - buyers, suppliers and related industries. Territorial innovation and industrial clusters are based on a stable system of dissemination of new technologies, knowledge, products, the so-called technological network, which is based on a joint scientific base. The latter are focused on the exchange of strategic know-how and achievements of long-term partnership agreements. Continuous interaction facilitates formal and informal exchange of information about the prospects for cooperation between organizations with complementary assets and professional skills. The exchange of information, production experiences, and R&D results leads to the improvement of educational and scientific institutions and the creation of a developed social and cultural capital. As a result, the region of the country becomes an attractive center for foreign investment, which in turn accelerates the economic development of the country as a whole.

5. Clusters are a great importance for improving the competitiveness of an economic region. The competitiveness of enterprises in clusters leads to an increase in the competitiveness of the industry and the country's regions as a whole. Clustering increases the scale of activities, increases the demand for factors of production, including labor, and stimulates the growth of exports outside the region and the flow of financial resources. Competitive clusters have a large contribution to the value chain. They create a synergy effect based not so much on tangible, but rather on intangible assets, which are characterized by the creation of high added value.

6. Clusterization affects the growth of wages and living standards of the population. The expansion of the cluster is due to the acceleration of research and innovation activities in the region and the formation of a highly qualified workforce. Improving the skills of employees in the cluster guarantees higher wages for work due to increased productivity in the activities of firms in clusters and increased cash flows from outside. The increase in wages, in turn, affects the income of the population and the well-being of the region's labor resources. As a result, the region becomes an attractive center for specialists and workers from other regions. By providing high employment in the region, clusters contribute to the development of local infrastructure and improve the



living conditions of the region's population.

7. Clustering contributes to business development and the formation of new forms of entrepreneurship in the region. With the development of the cluster, create conditions for the specialization of labor resources and improvement of the business environment of the region.

8. Clustering contributes to the inflow of foreign investment in the region. Along with other factors, clusters play an important role in shaping the country's investment climate. As the formation of clusters in the regions enhances competitiveness not only of enterprises participating in the cluster, but also the economy of the region as a whole, which positively affects many aspects of life of the region and its population, socio-economic indicators. The formation and development of clusters contributes to the stabilization of the labor market, reducing the personnel deficit of enterprises, reorienting unprofitable enterprises and, ultimately, leads to an increase in investment activity. Creating conditions for accelerated business development and increasing the competitiveness of their constituent companies, clusters are more attractive centers for foreign investment. Investing in an enterprise network within a cluster that has a developed infrastructure with extensive interaction with educational and research organizations is characterized by relatively low risk and high returns. The inflow of foreign investment, in turn, can turn the region into a point of economic growth, which improves the image of the region before domestic and foreign investors. Active investment activity contributes to the diversification of the structure of the regional economy, increases its socio-economic indicators and creates additional jobs.

Thus, the positive effect of clustering industry in the region covers broad aspects of regional development. By intensifying research and accelerating innovation, clusters ensure the economic development of the most important sectors of the region's economy and increase the innovative potential of enterprises and stimulate intra-firm competition, strengthen the desire of entrepreneurs to innovate and modernize the production structure. All this contributes to progress in the regions and in the country as a whole.

The cluster approach contributes to the formation of newly created territorial production complexes in the region due to the high competitive advantage of such complexes, both on the global and national markets. By connecting the center and the environment through closer inter-firm interaction, regional clusters form common labor markets, facilitate the movement of technologies, and increase the availability of shared resources for enterprises. Due to the impact of scale effects and synergy, all cluster participants gain additional competitive advantages through the development of horizontal

network cooperative relations, as well as partnership between business, government, science and education. The synergetic effect of clusterization of the economy is expressed in the form of additional added value due to the effective interaction of economic entities, which is an integral element of the economic space of the cluster.

Considering the key advantages of clusters in the regional economy, it is necessary to say that the development of integration relations between industry enterprises gives a serious boost to the prosperity of the region's economy and the elimination of inefficient production structures operating in the region. Especially, effective interaction of government bodies with business solves problems related to the development of public-private partnership in the economy. In the future, the regions where clusters are formed will become the leaders of the country's economy and determine the competitiveness of the national economy. In addition, clusters contribute to regional and national development based on innovative technologies, which indicates the importance of the cluster for the sustainable development of the region.

## LITERATURE

1. Гуриева Л.К. Синергетические эффекты кластерной организации промышленных предприятий // УЭКС, 2013. - №12 (60). URL: <https://cyberleninka.ru/article/n/sinergicheskie-effekty-klasternoy-organizatsii-promyshlennyh-predpriyatiy> (дата обращения: 06.10.2018).
2. Портер М. Конкуренция. - М.: Изд. Дом «Вильямс», 2003. - С.376.
3. Беспалов М.В. Роль и значение инновационных кластеров в осуществлении национальных и региональных инновационных программ развития//Качество. Инновации. Образование. - М.: ПК «СТС-Принт», 2009. - №2. - С.23-27.
4. Куркудинов Е. В. Кластерный подход как технология управления экономическим развитием региона. [Электронный ресурс], Режим доступа: [ecsocap.hse.ru> data/2011/03/22/1268220201/35.pdf](https://ecsocap.hse.ru/data/2011/03/22/1268220201/35.pdf).
5. Ханкелдиева Г.Ш. Особенности корпоративного управления в акционерных обществах с государственным участием // Бюллетень науки и практики. Электрон. журн. 2017. №11 (24). С. 357-363. Режим доступа: <http://www.bulletennauki.com/honkeldiyeva>
6. Ханкелдиева Г. Ш. Перспективы развития электроэнергетической отрасли Республики Узбекистан в условиях модернизации экономических отношений // Бюллетень науки и практики. Электрон. журн. 2017. №12 (25). С. 293-299. Режим доступа: <http://www.bulletennauki.com/honkeldiyeva-g> (дата обращения 15.12.2017).



7. Khankeldieva G.Sh. Prospects of the development of investment activity in the field of tourist services: problems and ways of solution. // *International Scientific Journal "Theoretical & Applied Science"*, Philadelphia, USA. 10, (78), 2019. – 160-165 pp.
8. Мирзаев А.Т. Оценка использования рекреационных возможностей на рынке туристических услуг // *Региональная экономика: теория и практика*. – 2019. – Т. 17, № 5. – С. 990 – 1002. <https://doi.org/10.24891/re.17.5.990>
9. Mirzaev, A. T. (2020). Assessment of cluster formation in management of recreational activity. *ISJ Theoretical & Applied Science*, 04 (84), 605-610. <https://dx.doi.org/10.15863/TAS.2020.04.84.101>
10. Mirzaev, A.T (2018) "The level of use of tourist attractions in the regions and the factors affecting them," *Economics and Innovative Technologies*: Vol. 2018: No.3,Article19.Available at: <https://uzjournals.edu.uz/igtisodiyot/vol2018/iss3/19>
11. Мирзаев, А. Т. (2019). Совершенствование интегральной оценки механизма рекреационно-туристических объектов. *Бюллетень науки и практики*, 5(2). – С. 127-134. <https://doi.org/10.33619/2414-2948/39/17>
12. Mirzaev A. T. Estimation of the prospects for the use of recreational facilities in the market of tourism services // *Наука сегодня: вызовы, перспективы и возможности [Текст]*. – 2018. – С. 76.
13. Mirzaev A. T. Evaluation of innovation capacity resource components in effective management of recreational clusters on the basis of econometric analysis // *EPRA International Journal of Research and Development (IJRD)*. – 2020 . – pp.131-137. <https://doi.org/10.36713/epra4790>
14. Асракулов, А. С. (2019). Неформальная занятость и анализ факторов, влияющих на неформальную занятость в Узбекистане. *Региональная экономика: теория и практика*, 17(12), 2328-2336. <https://elibrary.ru/item.asp?id=41473273>
15. Asrakulov, A. S. (2017). Some aspects of development of the labor market of the Republic of Uzbekistan. *Актуальные проблемы социально-гуманитарных наук* (pp. 39-42).
16. Орипов А. А. (2019) Развитие информационно-коммуникационных технологий в Узбекистане. *Образование и наука в России и за рубежом*, (16).



## **NOISES OF ELECTRONIC DEVICES (GENERAL INFORMATION, SOURCES)**

**Gulkhayo Oybekovna Akbarova**

*Teacher of Andizhan State University, Republic of Uzbekistan*

Article DOI: <https://doi.org/10.36713/epra4857>

### **ABSTRACT**

*In the article have been shown the analysis of the main approaches to the classification of internal electrical noise in electronic semiconductor devices. Classifications of electrical noise for each of the selected features are presented.*

**KEY WORDS:** *Thermal noise, flicker noise, Gaussian noise, white noise, frequency noise.*

### **INTRODUCTION**

The physical processes that were considered in the study of electronic devices were considered deterministic, although in fact these processes are influenced by various random factors causing fluctuations (random changes) in the currents and voltages in the circuits of the devices. Fluctuations in voltage (or current) at the terminals of electronic devices and devices are usually called noise. Noises are inherent in all electronic devices, and they are caused by the random nature of the movement (at the microscopic level) of charge carriers inside electronic devices. Noise is often a factor imposing restrictions on the characteristics of electronic devices, in particular, on their sensitivity. Sometimes noise can be used as a means to study the electrical characteristics of the system itself.

### **METHODS**

Usually noises in electronic devices are considered as stationary random processes in the time or frequency domain, so the main characteristics of noise are: the average value of the implementation of this random process (expectation); spectral density giving the average spectral component of the fluctuating signal; variance characterizing the energy of noise with a mathematical expectation (Average value) equal to zero; an autocorrelation function that

determines the statistical relationship between two values of a random function  $x(t)$ , separated by a time interval  $\tau$ , and a number of other characteristics, the meaning and value of which will be given as they are used.

### **RESULTS AND DISCUSSIONS**

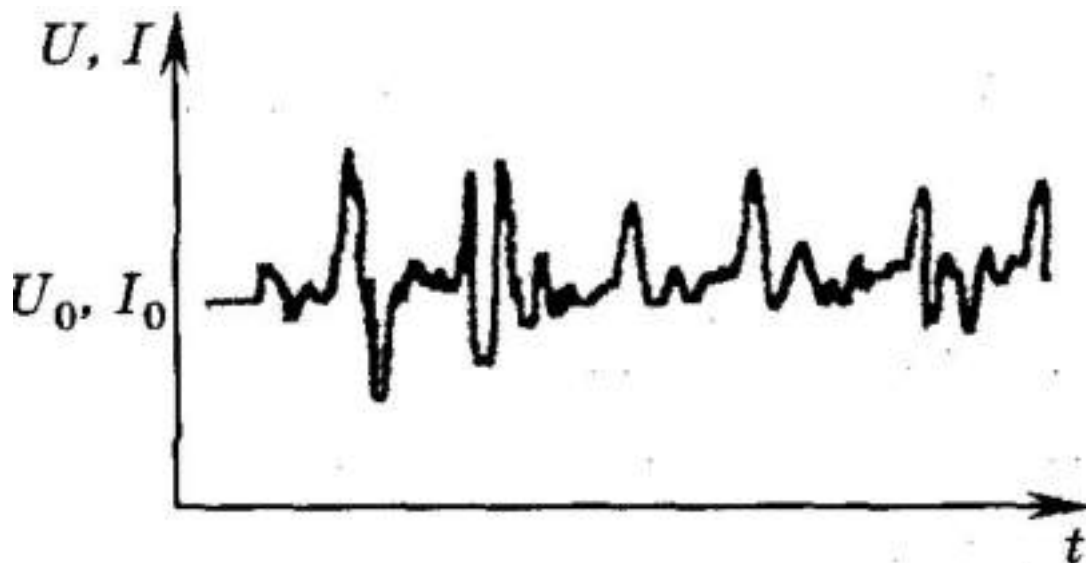
The main types of noise that appear in electronic devices include: thermal, diffusion, shot, generation recombination,  $1/f$  noise, current distribution noise, noise of secondary emission, avalanche multiplication, explosive, ionic and some others [1].

Thermal noise arises due to random fluctuations in the velocity of charge carriers in the medium in the device. Carrier velocity fluctuations, in turn, cause random changes in the carrier density and, as a consequence of these processes, current and voltage fluctuations appear. Thermal fluctuations do not violate the thermal equilibrium of the system, since a random (microscopic) deviation of an electro physical parameter from the equilibrium state is followed by an (average) return to it. A large number of microscopic events of this kind lead to a noticeable change in the current or voltage at the terminals of the device, resistor, etc.





Figure 1.



Shot noise is associated with the passage of free charge carriers through a potential barrier. It was first discovered in electron tubes. The name of this type of noise is due to the fact that the sound from the speaker installed at the output of the tube amplifier, at a high gain in the absence of a useful signal at the input, resembled the sound of a fraction falling on a steel sheet. Simple shot noise represents current fluctuations caused by electrons or holes, which are emitted randomly and independently from each other, without interacting with each other. In solid state devices, for example, diodes and transistors, carriers from the emitter exit randomly and move through the potential barrier of the depleted  $p-n$  junction layer, causing shot noise. In vacuum and gas-discharge devices, electrons are randomly emitted from the cathode and then moved to the anode under the influence of an electric field. These electrons randomly overcome the potential barrier formed at the boundary of the cathode with a vacuum or a working medium. Both in solid-state and in vacuum devices, the current generated by carrier flows fluctuates around an average level, which is associated with the discrete nature of emission (see Fig. 1). Although the physical nature of thermal and shot noise is different, the form of noise signals is similar in both cases [2]. In either case, it can be represented as a large sequence of random impulses that are similar in shape and randomly distributed over time.

However, we emphasize that shot noise in lamps, in contrast to thermal noise in conductors, occurs during a substantially no equilibrium process, in which the movement of carriers is due to an

external field and there is completely no interaction of carriers with both the medium and each other.

Diffusion noise is due to the probabilistic nature of charge carrier diffusion. For semiconductor materials, this type of noise is the cause of thermal noise, and for devices with  $p-n$  junctions, it is the main component of shot noise.

Current noise, or  $1/f$  noise, flicker noise, contact noise, excess noise - these are all different names of  $1/f$  noise [3]. This name is due to the fact that the spectral power density of this noise varies depending on the frequency according to the law  $f^{-\alpha}$ , where  $\alpha \sim 0.8 \dots 1.2$ .

From the side of ultra-low frequencies, this dependence is observed up to  $f \sim 10^{-6}$  Hz. At high frequencies,  $1/f$  noise is masked by thermal, shot or some other type of noise. At the moment, there is no unified theory of this phenomenon, although individual particular models can describe such noise quite well in some types of devices. Apparently,  $1/f$  noise is a combination of a sufficiently large number of different physical phenomena that obey the same regularity.

Based on the available data, it can be concluded that the causes of  $1/f$  noise in different cases are different.  $1/f$  noise can be represented as a random sequence of pulses of a certain shape  $u(t) \sim t^{-1/2} U(t)$  where  $U(t)$  is the unit step function:  $U(t) = 1$ , for  $t > 0$ ,  $U(t) = 0$  for  $t < 0$ , for which the spectral density varies as  $f^{-1}$  in a wide frequency range. Such a formal representation does not yet provide an idea of the physical mechanism that generates impulses of this form. Noise obeying the law when the spectral density is inversely proportional to the frequency appears in all materials



and elements used in electronics: intrinsic semiconductors, resistors, devices on  $p-n$  junctions, films, liquid metals and solutions of electrolytes, lamps with thermal cathodes, superconductors and Josephson transitions, etc. Despite a very large number of experimental facts, it is still not possible to say with certainty whether  $1/f$  noise belongs to volumetric or surface phenomena. In some types of devices, for example, MIS transistors, this is surface Effect. In this case, the semiconductor – oxide interface plays an important role in the occurrence of noise. For other types of devices, for example, for homogeneous resistors, this is a volumetric effect due to fluctuations in the number or mobility of charge carriers. Sometimes the obtained experimental data speak in favor of fluctuations of both the number and mobility of carriers at the same time. The most reliable data on the spectral density of  $1/f$  noise in homogeneous materials. There is an empirical law according to which the spectral density of  $1/f$  noise is inversely proportional to the total number of charge carriers in the sample. Although there is no theoretical justification for this law and there is no connection with any physical mechanism for the occurrence of  $1/f$  noise, it apparently reflects a characteristic feature of many phenomena accompanying  $1/f$  noise. In substantiating this empirical law, the most widely discussed mechanism was the presence of traps on the surface and the exchange of energy of the device or material with the environment during thermal equilibrium.

As already noted, the physical mechanism responsible for  $1/f$  noise can manifest itself in each case in the characteristic features of the shape of the noise signal; otherwise, it is assumed that the analysis of the mathematical description of a process with the characteristics of  $1/f$  noise can lead to an understanding of physics underlying this phenomenon. Currently, two process models having the shape of a  $1/f$  spectrum are most widely used:

1) A model of a random train of pulses;

2) A model based on a superposition of a large number of relaxation processes with a wide variation of characteristic time constants.

The second model is used more widely, since it is directly related to  $1/f$  noise in MOS transistors associated with surface phenomena. In accordance with this mechanism, carriers tunnel between the energy states of the semiconductor and the levels of traps localized in the dielectric (oxide) layer, which is confirmed by the practical absence of  $1/f$  noise in field effect transistors (PTs) with pn junctions, where surface phenomena are weakly manifested. At the same time, in a MOSFET with a large semiconductor – oxide interface, the component caused by this type of noise is dominant in the overall noise spectrum. As the experiment shows, in this

case, the noise intensity is extremely sensitive to the quality of the surface, and the spectral dependence, as a rule, remains the same, i.e.,  $\sim 1/f$ , regardless of the state of the surface. Therefore, each new, subsequent oxide layer causes the appearance of an intrinsic  $1/f$  spectrum, and does not shift the HF boundary of the already existing spectrum towards lower frequencies due to the large time constants of deeper traps. The widely accepted McWarter theoretical model, based on carrier trapping by surface traps, describes only a very particular noise mechanism in semiconductors. The presence of  $1/f$  noise in metals and other materials, the strong temperature dependence of  $1/f$  noise in metal films, and a number of other processes with a  $1/f$  spectral dependence have not yet been completely explained [4].

Generation-recombination noise arises in the process of generation and recombination of both equilibrium and no equilibrium carriers. In these processes, electrons and holes appear and disappear randomly. The random nature of the appearance and disappearance of free carriers leads to fluctuations in the resistance of the semiconductor or in individual areas of the device, where the processes of recombination and generation of free carriers are realized. If a direct current is passed through a sample of such a semiconductor, then at its ends, in addition to the constant, the fluctuation component of the also arises.

Most semiconductor devices have carrier-depleted regions, such as electrical transitions of various kinds. When carriers diffuse from one or another bulk region into the depletion layer, carriers can cross and leave it, or be reflected from it, or, finally, some of the carriers can be captured by recombination centers (traps) inside the layer under consideration. In the latter case, current pulses will appear in the external circuit, which form a recombination current (see § 1.3, 2.5). This current consists of a stationary component, on which fluctuations are superimposed, due to the random nature of the recombination. If the carriers are formed in the depleted layer, then the electric field in it separates the carriers and makes them move in the direction of those bulk regions where they are the main ones.

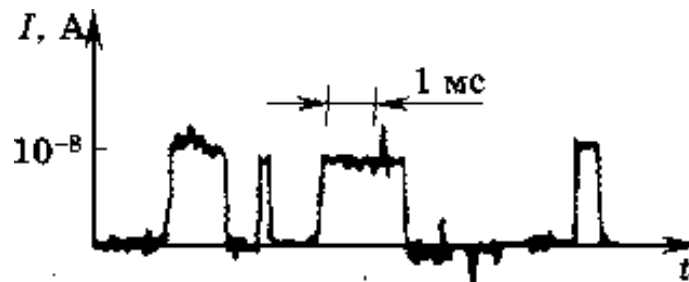
The generation processes are accompanied by the appearance of current pulses in the external circuit that have the opposite sign compared to pulses arising from recombination. The generation current also consists of a stationary component and superimposed generational fluctuations distributed according to a random law. Thus, the process of generation and recombination of carriers is associated with their random appearance and disappearance, and these phenomena can be considered as a sequence of independent random events similar to shot noise.



Therefore, to describe generation-recombination noise, one can often use formulas obtained for the analysis of shot noise with the introduction of appropriate corrections that take into account the specifics of the process.

Explosive noise is manifested, as a rule, in devices such as diodes, transistors at  $p-n$  junctions, tunneling diodes, and composite resistors. In its simplest form, explosive noise appears as a bi stable signal (with two levels) of a stepped shape, with small changes in amplitude and with randomly

distributed time intervals between steps (like a random telegraph signal). However, sometimes there are signals with several levels of amplitudes (steps). It is assumed that the explosive noise at reverse biased  $p-n$  junctions is due to the irregular switching on and off of the surface conduction channels. With direct switching on, the cause of this noise is crystal defects in the transition region, and the main role is played not by metallic impurities, but by defects like dislocations.



**Figure 2**

A typical implementation of bi stable explosive noise is shown in Fig. 2. It consists of random step emissions with white noise (having a uniform spectrum in a wide frequency range from 0 to 1013 Hz). It is believed that the signal is symmetric if the average duration time of each of the two levels of the stage is the same, and asymmetric if there is a significant deviation from such a condition.

Avalanche and micro plasma noise are associated with avalanche multiplication, which takes place in regions of a strong electric field, where the kinetic energy of free charge carriers is sufficient for ionization of the atoms of the crystal lattice. The ionization processes underlying the multiplication of carriers occur randomly, thus creating noise in the current of avalanche ionization. The avalanche multiplication of carriers finally leads to a breakdown of the  $p-n$  junction. The generation of electron-hole pairs during multiplication ultimately forms an electron-hole plasma. Quite often, breakdown processes are not realized over the entire transition area, but in separate, sometimes microscopically small areas, where, due to various kinds of defects, the greatest electric field strength exists and micro plasma is formed as a result of breakdown. The realization of micro plasma noise is often similar to the realization of explosive noise, but with an amplitude much larger ( $\sim 10^{-5}$  A), while the amplitude of the explosive noise signal is  $10^{-8}$  A in order of magnitude.

The micro plasma itself is localized inside the transition in regions of a strong electric field with characteristic dimensions of several hundred angstroms, in which cracks and other defects of the

crystal lattice contain traps. These traps, capturing free carriers, form an increased charge density, which causes the appearance of a strong field. The formation and subsequent destruction of micro plasma is a random process, which leads to the observed stepwise changes in the transition current.

Current distribution noise occurs when current is shared between the electrodes of a device, such as a transistor or pentode. The nature of the current distribution is random in nature, mainly due to fluctuations in the transverse component of the electron velocity. These noises are also influenced by fluctuations in the cathode current or emitter current, potential fluctuations on the electrodes, various field inhomogeneities, instabilities of the electro physical parameters of the electrodes, etc.

All these reasons lead to a random change in the direction of motion of the electrons and, as a consequence, the interception of electrons by a grid in an electric vacuum tube or other electrode in another type of device is random, which causes current fluctuations in the electrode circuits.

Secondary emission noise is due to the fact that the secondary emission coefficient from the electrodes of electron tubes is variable over time due to the instability of the primary electron current, surface imperfections, the presence of various impurities, inhomogeneities, and foreign inclusions in the material of the secondary cathode. In conventional receive-amplification lamps, noise caused by secondary emission is usually much less than shot noise and current distribution noise.

Radiation (photon) noise is determined by fluctuations in the parameters of the light signal



(radiation) incident on the receiver, i.e., fluctuations in the number of photons incident on the photosensitive layer of the photo detector that come from the emitter and elements of the receiver itself. In addition to those considered, in electronic devices there are some other types and sources of noise.

### CONCLUSION

The analysis showed that in the scientific literature there are four main approaches to the classification of electrical noise in semiconductors:

- 1) Classification by the physical nature and mechanism of occurrence;
- 2) Classification according to the behavior of spectral density and probability density;
- 3) Classification from the point of view of the theory of random processes;
- 4) Classification by external manifestation.

In cases where the subject of the study is the noise itself and the causes of their occurrence, classifications are used according to the first three signs. In cases where the subject of the study is to reduce the noise level in electronic devices, use the classification of noise by external manifestation.

### REFERENCES

1. Van der Zil A. *Noise. Sources, description, measurement. M.: Sov. radio, 1973.*
2. Van der Zil A. *Fluctuations in radio engineering and physics. M.; L.: Gosenergoizdat, 1958.*
3. Horowitz P., Hill W. *The Art of Circuitry. - Moscow: World, 2003.*
4. G.G. Shishkin., A.G. Shishkin. *Electronics. – Moscow: Bustard, 2009.*



# TEACHING ENTREPRENEURSHIP REDIRECT FOR YOUNG PEOPLE IN MODERN CONDITIONS

**Makhliyokhon Madaminjonovna Mirzakarimova**

*Researcher of Andizhan State University, Andizhan region, Republic of Uzbekistan*

Article DOI: <https://doi.org/10.36713/epra4858>

## ABSTRACT

*This article analyzes the importance of the system of entrepreneurship-oriented education in the training of entrepreneurs. In addition, the study provides insights into the educational process aimed at training entrepreneurs at various stages of human activity, not only in public educational institutions, but also in the formation of a market economy, business development and the ability to realize their potential as well.*

**KEY WORDS:** *Development of entrepreneurship, business education, management, business process, production, human activity, economics, public education.*

## INTRODUCTION

According to global trends, the preparation of young people for entrepreneurship will create jobs in the education system of advanced countries and reduce unemployment, increase the volume of goods and services, the introduction of social programs and solve other socio-economic problems [1, p.37-42]. An important task of economic reforms in our country is to increase the economic efficiency of production, and the main way to solve it is to increase the interest of workers in the results of labor [2].

## METHODS

There are some methods in the field of entrepreneurship-oriented education in the training of entrepreneurs. Also, market relations have led to an increase in the demand for employees who have the ability to do business in the labor market, to solve various problems in their workplace.

## RESULTS AND DISCUSSIONS

Radical changes in social, production and management relations, the emergence and development of economic structures based on different forms of ownership require the establishment of a system of additional educational institutions in the form of business education,

meeting the needs of the economy and population, professional compactness.

The system of entrepreneurship-oriented general education is one of the most important forms of training of entrepreneurs. is calculated.

One of the main conditions for the development and expansion of small business and private entrepreneurship is the training of qualified entrepreneurs. The deepening of market relations, the expansion of production of goods and services that meet the needs of consumers, the growth of employment depends on the knowledge and skills of the leaders of private enterprises. The modern economy is formed by intelligent entrepreneurs who know their job well.

The need for a system of entrepreneurship-oriented teaching of general education has arisen in connection with the introduction of market relations, denationalization, privatization and the emergence of various forms of ownership [3]. Private property has led to the formation of a class of entrepreneurs who require knowledge in addition to the general education and vocational knowledge previously acquired.

To implement this idea, it is necessary to train the population in business. Entrepreneurship-oriented teaching of general subjects and vocational training of students is the main system that ensures the





maintenance and increase of human capital in the country. The speed and efficiency of knowledge transfer by education systems determine the rate of development of human capital. The formation of human capital affects the growth rates of the property class.

The unified system of education, training for the non-governmental sector of the economy, should begin in secondary and vocational schools and end in secondary special vocational and higher education institutions, as well as in the system of postgraduate vocational education (postgraduate education).

Establishment of such a system requires concerted action of government agencies, social organizations, the media at various (territorial, municipal) levels. These actions are based on the adoption of state legislation, the allocation of special funds, the interaction of all interested organizations. A positive result can be achieved through the combined efforts of all levels of education, from secondary special to higher and alternative business education system. Many agree, but the ability of the state and society to use this support to the end is one of the most pressing issues.

In order to better understand the role and place of the system of entrepreneurship-oriented education, we need to define its main function, the content of the education system, because today the training, education and training of qualified personnel for all sectors of the economy is mainly the responsibility of entrepreneurship-oriented education. In addition, the continuous improvement of the general education and special professional level of those engaged in public production is becoming a necessity of society and the market economy. Therefore, the content of the education system, including the system of entrepreneurship-oriented teaching of general education subjects, is in a continuous stage of development [4].

Despite the large allocation of resources by the state, the new tasks of business education and training for the business sector require further expansion of funding sources. The share of education costs in the cost of a competitive product in world markets is at least 10% [5, p.170]. Most businesses in the country allocate very little to improve the skills of their employees, within 2-3% of the total cost of enterprises, due to high production costs, a number of tax burdens that reduce the interest of businesses to expand production and innovation.

For the private sector of the economy, the improvement of the system of entrepreneurship-oriented teaching of educational institutions necessitated the transition to life itself, the transition to market relations, especially to increase

employment in rural areas [6, p.62-64]. The acquired knowledge is used in business.

The requirements of the state concept in the system of entrepreneurship-oriented teaching of public and private structures should be based on the following principles [7]:

- universal values and the priority of free development of the individual: fostering patriotism, diligence, respect for human rights and freedoms;

- Equality of education for all, flexibility of the education system to the level and characteristics of the development of entrepreneurship training:

- freedom and pluralism of business education;

- continuity and consistency of the education system;

- Integration of general, secondary special, higher education and postgraduate education, while preserving the achievements of science and technology and national traditions in the global business and entrepreneurship-oriented education system [8];

- Transparency in determining the direction of development of science and technology, as well as training, retraining and advanced training of employees of business structures.

In the concept of an entrepreneurship-oriented education system, ensuring the continuity of education should be shaped by historical and national traditions. Normative legal acts should ensure the delimitation of powers in the field of education between public authorities and education authorities at different levels, as well as public and non-public education systems. The constitutional rights of citizens to receive any type of education, including postgraduate education, must be protected. It is also necessary to create legal guarantees for the free operation of entrepreneurship-oriented training and business education in the territory of Uzbekistan, defining the rights, obligations, powers and responsibilities of individuals and legal entities in this form of training, as well as the legal regulation of their relations.

In-depth knowledge in the field of marketing, management, finance, accounting from a growing business sole proprietor; to know how to compromise; requires the ability to negotiate and work in a team. It is necessary to cover a set of general education disciplines in the training of specialists for business and entrepreneurship.

Nowadays, the main requirements for training young entrepreneurs are knowledge, management skills and personal entrepreneurial characteristics (**Table 1**).



**Table 1. Requirements for training young entrepreneurs [9]**

Knowledge	Management skills	Personal business characteristics
business opportunity opportunity to create business plans know how to serve customers production processes ability to negotiate business management market competitors legal basis of entrepreneurship sources of assistance and funding	marketing financial management production and organization of labor planning leadership coaching: a modern type of personnel management	leadership to act within the limits of possibilities search for information individually practice ability to perform contracts problem solving regular planning ability to take risks

The deepening of economic reforms, investment policy and active structural changes in the economy, the development of small business and private entrepreneurship, the expansion of the network of market structures and self-employment have led to the development of non-traditional forms of educational institutions.

It should be noted that in the system of entrepreneurship-oriented education, due to the lack of state standards and a clear mechanism for training teachers of general education, training can not

quickly adapt to the changing needs of retraining for a market economy. Market relations demanded the transition from a unitary, state-style form of education to a system of selective education. This has become a key area of education reform in the country.

In this case, “Who to be?” The question is “Who needs it?” that is, the training of the labor force must be in accordance with the requirements and needs of the economy (Table 2).

**Table 2. Demands and needs of the economy in the system of entrepreneurship-oriented education [10]**

Who to be?	Who needs it?
Orientation of students to the scientific and organizational profession in accordance with the needs of the economy	Ensuring that knowledge is constantly in line with the requirements of new techniques and technologies Development and improvement of workforce training processes, such as retraining and advanced training of personnel Creation of a system of professional and professional development of personnel Selection of the most effective forms of training

**CONCLUSION**

In our opinion, in order to meet the needs of the Uzbek economy for entrepreneurial personnel in the context of deepening market reforms, it is necessary to develop a more effective program of entrepreneurship-oriented general education. The program should take into account the promising trends in the formation of entrepreneurial skills in students and the growth of the number of self-employed youth, and provide for the expansion of the use of various forms of training of broad-based entrepreneurs. In addition, it is necessary to consider what new factors may affect the training of personnel in Uzbekistan.

The following factors affect the demand for specialists in a wide range of areas, both in the public and private sectors:

- development of labor;
- the need to meet ever-increasing needs;
- The need to increase labor productivity;
- Technological and industrial changes;
- The need for training and retraining of personnel directly in the firm;
- Introduction of new types of professions in world practice.

In this regard, business education will increase the following sides:

- Becomes a comprehensive education in the teaching of know-how;



- Be responsible, which allows you to quickly adapt to changes;
- Motivated, which helps to develop in each student the desire to continue learning;
- Integrated, ie rationally combines theoretical and practical reading.

## REFERENCES

1. *Teaching Business Ethics: IN THE AGE OF MADOFF*. Author(s): R. Edward Freeman, Lisa Stewart and Brian Moriarty. Source: *Change*, Vol. 41, No. 6 (November/December 2009), pp. 37-42. Published by: Taylor & Francis, Ltd. Stable URL: <http://www.jstor.org/stable/20696192>. Accessed: 18-04-2018 11:24 UTC.
2. Bakieva I.A. *The system of training entrepreneurs in Uzbekistan and the features of its reform* Scientific electronic journal "Economy and Innovative Technologies", T., 2011, No.2.
3. Robson, Colin. 2002. *Real World Research: A Resource for Social Scientists and Practitioner-Researchers*, Malden: Blackwell.
4. Polonsky V.M. *Research methods of educational problems*. –M: Pedagogy, 1994.
5. *Formation a culture of independent thinking in the educational process: materials of the international scientific conference on November 10–11, 2015.- Prague : Vědecko vydavatelské centrum «Sociosféra-CZ», 2015. – 170 p. – ISBN 978-80-7526-061-1.*
6. Sharipova M.H. *Entrepreneurial activity is a characteristic feature of a leader in school management // Educational technologies, T., 2016, issue 6 - pp. 62-64.*
7. <http://www.jstor.org/stable/25072888>.
8. University Microfilms. 300 North Zeeb Road. Ann Arbor, Michigan 48106. A Xerox Education Company. NEW YORK U N I V E R S I T Y. SCHOOL OF EDUCATION. HORARY.
9. Malikov T. *Financial management - T: "Academy" - 1999.*
10. <http://www.jstor.org/stable/20696192>.



## **A STUDY ON PERFORMANCE APPRAISAL MEASURES WITH REFERENCE TO ANIMATION INDUSTRY**

**Dr. Vanaja.V**

*Associate Professor, Department of Management Studies, Sri Ramakrishna Engineering College, Coimbatore*

**Radhika.V**

*Student, Department of Management Studies, Sri Ramakrishna Engineering College, Coimbatore.*

### **ABSTRACT**

*Performance appraisal is a major management practice to assess the immediate and future relevance of any worker in any given organization. Even today in the era of globalization, Performance Appraisal has become very important and a dire necessity for the employees both in the private as well as public sector organization. Performance appraisals are intended to evaluate the performance and potential of employees. Performance appraisal errors affect the validity and dependability of the performance appraisal systems. The study has been carried out with the objective to understand the satisfaction of employees with regard to the performance appraisal system in the organization and to find out the effectiveness of the performance appraisal system in the organization.*

**KEY WORDS:** *globalization, organization goals, peak performance.*

### **I. INTRODUCTION**

Performance appraisal is the process of evaluation of an employee at higher levels. In order to know whether the selection of an employee is right or wrong, performance appraisal is resorted to. Promotion, transfer, salary increase etc. are some of the matters that are dependent upon the evaluation of the performance of an employee. The qualities of employees that are appraised through performance appraisal are ability to do work, spirit of co-operation, managerial ability, self-confidence, initiative, intelligence etc.

### **II. OBJECTIVES**

1. To understand the satisfaction of employees with regard to the performance appraisal system in the organization.

2. To find out the effectiveness of the performance appraisal system in the organization.

### **III. SCOPE OF PERFORMANCE APPRAISAL**

- This study has scope as it covers a wide range of the effectiveness of the performance appraisal system.
- Increase commitment to organizational goals; develop employees into future supervisors.
- Allow time for self-reflection, self-appraisal and personal goal setting.

### **IV. REVIEW OF LITERATURE**

Muczyk and Gable (1987). The high degree of success or failure of any organization depends on how performance is managed within it. It would be impossible for an organization to achieve its goals,



for instance, giving best employees a sizable pay increase, spot individuals ready for promotion, justifiable grounds for termination of poor performer, and undertaking successful human resource planning, if managers do not give prime concern to make better the performance appraisal of the organization. As to date, it is argued that every performance appraisal system created by organizations contains deficiencies hindering it from successfully attaining its goals in the organization.

Shivali Jindal, Laveena, Navneet (2015) has conducted a study on “Effectiveness of performance appraisal system in selected Indian companies”. This study is to understand the perfect setting of performance standards and expectations by observation and providing feedback and the conduct of different appraisal methods helps to achieve the excellent results by managing the performance of the employees. This whole process is known as Performance Management. In other words, it is the process which is designed to understand the pre-fixed work standards in an organization.

Sujith A S (2017) has conducted a study on “Performance appraisal practices in Indian industries”. This paper aims to provide a review on the various performance appraisal techniques practiced in Indian economy. Performance Appraisal (PA) is gradually becoming a part of a more strategic move towards integrating HR practices and organizational objectives and might now be seen as a general term covering a range of actions through which organizations seek to measure employees and increase their competence, improve performance and distribute rewards. Globalization has created a niche to sustain and enhance human resource since they are the prime contributors to organizational performance.

## V. STATEMENT OF PROBLEM

Performance appraisal is important for organizations and employees. Unfortunately, performance appraisals are not on the top of the list of "favorite things to do" for either managers or employees, and there can be a number of problems with their administration. From managers not being trained to conduct performance appraisals effectively to the failure to tie performance appraisal expectations to desired business results, businesses are often challenged to use this tool effectively. Performance

appraisals rarely focus on developing the employee's skills and abilities. They do not provide commitments of time and resources from the organization about how they will encourage employees to develop their skills in areas of interest to the employee.

## VI. METHODOLOGY

To conduct this study, both secondary and primary data sources were used. Secondary data were obtained direct from written documents. Primary data were obtained from Questionnaire.

### PRIMARY DATA:

The primary data are those, which are collected freshly and for the first time, from the employees directly. it is collected through the following methods.

1. **Questionnaire:** A structure of questionnaire was prepared and distributed among the employees & workers.
2. **Interview:** Personal interviews and interaction with the employees and contractor labours.
3. **Observation:** By observing the working environment.

### SECONDARY DATA:

The secondary data are those which have already been collected by someone or else which have been passed through statistical process. Sources of secondary data can be categorized into two broad categorized named published and unpublished statistics.

## VII. METHODS USED FOR DATA ANALYSIS

The tools used for data collection are:

- Percentage Analysis
- Chi – Square

## VIII. LIMITATIONS

- If the standards are not clear, the supervisors may follow different standards for different employees.
- Through performance appraisal, only few qualities of employees can be measured. All individuals differ from each other in terms of background, values and behaviour.



**IX. ANALYSIS & INTERPRETATION**

## Percentage Analysis

**TABLE - 1 DEMOGRAPHIC PROFILE OF THE RESPONDENTS**

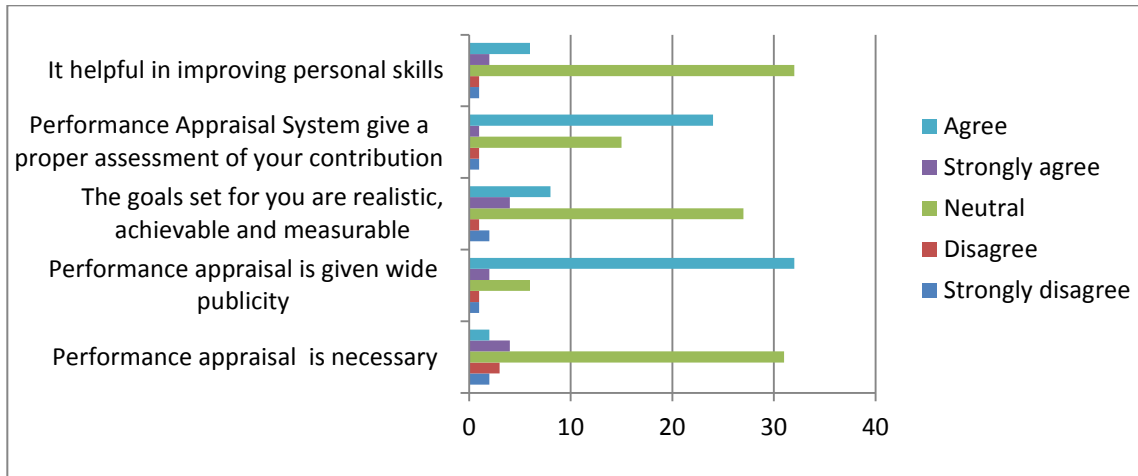
Demographic Profile		Percentage
Gender	Male	64
	Female	35
Age (in years)	Below 20	2
	20-24 yrs	52
	25-29 yrs	36
	30-34yrs	10
Educational Qualification	Diploma	10
	Graduate	52
	Post Graduate	36
	Doctorate	2
Work Experience	0-2 yrs	52
	2-5yrs	36
	5-10 yrs	12

**TABLE - 2 EMPLOYEES OPINION TOWARDS THE ORGANIZATION**

Sources	Strongly Disagree	Disagree	Neutral	Strongly Agree	Agree	Percentage
Performance appraisal is necessary	2	3	31	4	2	74
Performance appraisal is given wide publicity	1	1	6	2	32	76
The goals set for you are realistic, achievable and measurable	2	1	27	4	8	64
Performance Appraisal System give a proper assessment of your contribution	1	1	15	1	24	57
It helpful in improving personal skills	1	1	32	2	6	76



**CHART 1 EMPLOYEES OPINION TOWARDS THE ORGANIZATION**



The above analysis shows that majority (74%) of the respondents remains neutral with regard to their opinion whether performance appraisal is necessary for the organization; majority (76%) of the respondents agree that the performance appraisal is given wide publicity in the organization; majority (64%) of the respondents remains neutral with regard to their opinion that the performance appraisal goals set for

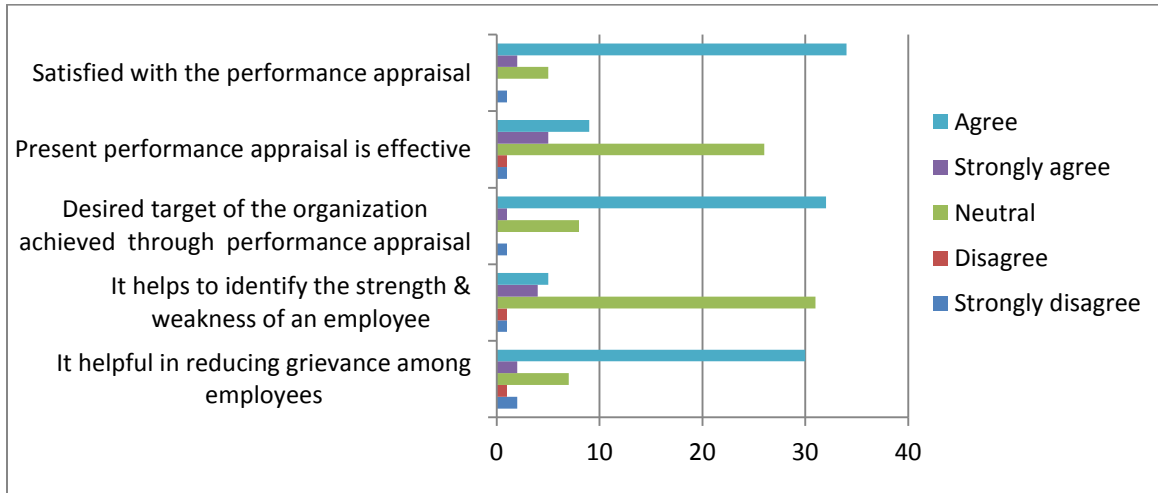
them are realistic, achievable and measurable; majority (57%) of the respondents agree that performance appraisal system gives a proper assessment of their contribution to the organization and majority (76%) of the respondents remains neutral with regard to their opinion that performance appraisal system is helpful in improving personal skills of the employees.

**TABLE - 3 LEVEL OF SATISFACTION TOWARDS PERFORMANCE APPRAISAL BY THE EMPLOYEES**

Sources	Strongly Disagree	Disagree	Neutral	Strongly Agree	Agree	Percentage
It helpful in reducing grievance among employees	2	1	7	2	30	71
It helps to identify the strength & weakness of an employee	1	1	31	4	5	74
Desired target of the organization achieved through performance appraisal	1	0	8	1	32	76
Present performance appraisal is effective	1	1	26	5	9	62
Satisfied with the performance appraisal	1	-	5	2	34	81



**CHART 2 LEVEL OF SATISFACTION TOWARDS PERFORMANCE APPRAISAL BY THE EMPLOYEES**



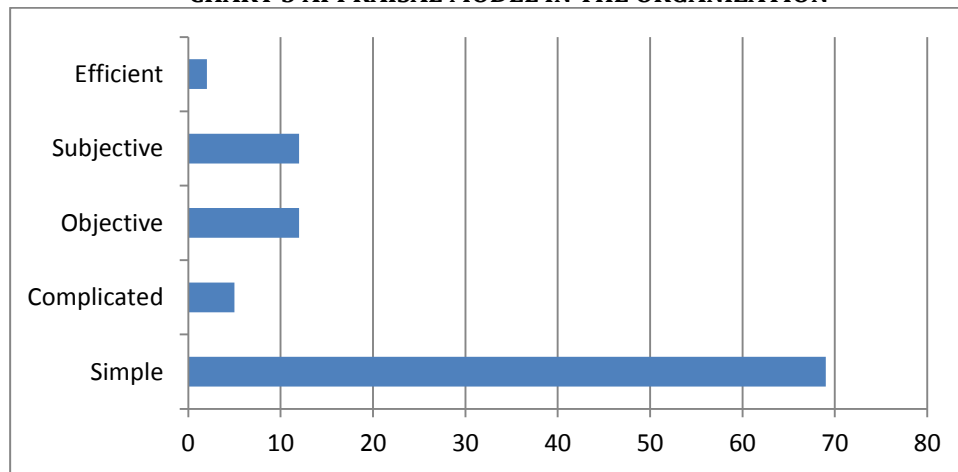
The above analysis reveals that majority (71%) of the respondents agree that the performance appraisal system is helpful in reducing grievance among employees; majority (74%) of the respondents remains neutral with regard to their opinion that the performance appraisal system helps to identify the strength and weakness of an employee; majority (76%) of the respondents agree that the performance appraisal

system help in achieving desired target of the organization; majority (62%) of the respondents remains neutral in their opinion regarding the effectiveness of performance appraisal system and majority (81%) of the respondents agree that they are satisfied with the present performance appraisal system.

**TABLE - 4 APPRAISAL MODEL IN THE ORGANIZATION**

Appraisal model	Percentage
Simple	69
Complicated	5
Objective	12
Subjective	12
Efficient	2

**CHART 3 APPRAISAL MODEL IN THE ORGANIZATION**





The above chart implies that 69% of the respondents expressed that the present appraisal system is simple, 5% of the respondents expressed that the present appraisal system is complicated, 12% of the respondents expressed that the present appraisal system is objective, 12% of the respondents expressed that the present appraisal system is subjective and only 2% of the respondents expressed that the present appraisal system is efficient. Therefore, majority (69%) of the respondents expressed that the present appraisal system is simple.

## XI FINDINGS

- Majority (72%) of the respondents expressed that they are satisfied with the current performance appraisal system.
- Majority (76%) of the respondents expressed that performance appraisal should be conducted once a month.
- Majority (67%) of the respondents expressed that the performance appraisal system is conducted in order to retain the employees of the organization.
- Majority (72%) of the respondents expressed that management frequently spell out the job expectations before carrying out the periodical performance appraisal.
- Majority (86%) of the respondents expressed that conflicts sometimes arise between employees after the conduct of performance appraisal
- Majority (56%) of the respondents felt that monetary incentives should be increased.
- Majority (67%) of the respondents expressed their opinion that performance appraisal should be carried out by all the superiors to bring out the best of an employee.
- Majority (74%) of the respondents expressed that feedback is provided to the employees within 15 days from the completion of the performance appraisal.
- Majority (88%) of the respondents prefer oral feedback.
- Majority (69%) of the respondents expressed that the present appraisal system is simple.
- Majority (60%) of the respondents expressed that management is using the present performance appraisal system for deciding the pay increase.

### The Chi-Square Analysis Highlights the Following Findings

**H0<sub>1</sub> : There is no significant relationship between the age of the respondents and their opinion about the present performance appraisal system.**

The calculated Chi square value is less than the table value at 0.05% confidence level, therefore the null hypothesis can be accepted. It can be understood from the above table that there is no relationship between age of the respondents and their opinion about the present performance appraisal system.

**H0<sub>2</sub> : There is no significant relationship between the Gender of the respondents and their opinion about the present performance appraisal system**

The calculated Chi square value is less than the table value at 0.05% confidence level, therefore the null hypothesis can be accepted. It can be understood from the above table that there is no relationship between Gender of the respondents and their opinion about the present performance appraisal system.

**H0<sub>3</sub> : There is no significant relationship between the Educational Qualification of the respondents and their opinion about the present performance appraisal system**

The calculated chi square value is more than the table value at 0.05% confidence level, therefore the null hypothesis is rejected. Therefore, it is understood that there is significant relationship between educational qualification of the respondents and their opinion about the present performance appraisal system with regard to Performance appraisal is necessary, reducing grievance among employees, and helps in identifying the strength & weakness of an employee.

The calculated Chi square value is less than the table value at 0.05% confidence level, therefore the null hypothesis can be accepted. It can be understood from the above table that there is no relationship between educational qualification of the respondents and their opinion about the present performance appraisal system with regard to wide publicity, realistic, achievable and measurable, proper assessment, improving personal skills, desired target of the organization, Present performance appraisal is effective, Satisfied with the performance appraisal.

**H0<sub>4</sub> : There is no significant relationship between the years of experience of the respondents and their opinion about the present performance appraisal system.**



The calculated Chi square value is less than the table value at 0.05% confidence level, therefore the null hypothesis can be accepted. It can be understood from the above table that there is no relationship between Year of the experience of the respondents and their opinion about the present performance appraisal system.

## XII. SUGGESTIONS

- Additional training should be offered to the mentally stressed staff which improve their potential and result in top appraisal points.
- The performance appraisal should be in a full fledged way so that others will be accepting this.
- Implement more methods of performance appraisal and update the employees about the type of method used for performance evaluation.

## XIII. CONCLUSION

Performance Appraisal is an important human resources practice which provides information to many critical human resource decisions. The option required strong motivation to face the challenges. For every organization to constantly realized its set goals, it is important that Performance Appraisal must become a regular exercise and must occupy central role of the management. The effectiveness of the Performance Appraisal system is also based on to the extent how well Human Resource Development in an organization is oriented.

## XIV. REFERENCES

1. Muczyk, Jan P. and Myron Gable (1987). *Managing Sales Performance Through a Comprehensive Performance Appraisal System*, *Journal of Personal Selling & Sales Management*, 7 (May),41-52.
2. Sujith A S (2017) has conducted a study on “ *Performance appraisal practices in Indian industries*”. 2017 IJNRD | Volume 2, Issue 5 May 2017 | ISSN: 2456-4184 .
3. Bernardin, H.J., and Russell, J.E. (1998), *Human Resource Management; An Experiential Approach*, 2nd ed, New York: Mc Graw Hill, Inc.
4. <https://www.managementstudyguide.com/performance-management.htm>
5. <https://exinfm.com/pdffiles/pm.pdf>
6. <https://www.opm.gov/policy-data-oversight/performance-management/overview-history>

7. <http://www.orau.gov/pbm/pbmhandbook/Volume%202.pdf>
8. <http://www.slideshare.net/ShaiikhIrshad/research-proposal-on-performancemanagement-system>.





## **BLOCKCHAIN METHOD IN DEVELOPMENT OF DIGITAL ECONOMY**

**Makhmudov Abdukhalil**

*Student, Tashkent University of Information Technologies named after Muhammad al-Khwarizmi, Faculty of Vocational Education in the field ICT*

### **ANNOTATION**

*The article discusses the current evolving digital economy in the world, its advantages, factors of development and the favorable conditions created by the digital economy. Blockchain technology will also be considered in the development of the digital economy.*

**KEYWORDS:** *Blockchain, e-government, online, smart city.*

### **DISCUSSION**

Today, the digital economy is evolving worldwide. Of course, with the advent of computer technology and the Internet in human life, it began to be widely used in all areas. In particular, it has affected the economy. The digital economy allows for the implementation of digital technologies in production and services in all areas. Currently, the United States and China are among the most developed economies in the world. According to statistics, these countries have the largest number of online commerce. Extensive work is being done to develop the digital economy around the world. The reason is that the digital economy creates favorable conditions not only in trade but also in many other areas. For example, the widespread use of digital electronic payment systems via the Internet in the global financial, credit and banking sectors provides fast and free settlements between businesses and the population without the involvement of the bank and sharply reduces settlement costs, as well as leading to a decline in the value of financial and credit reserves, dramatically increasing the efficiency of financial management of the state and the population as a whole, while resolving global debt problems and removing trade barriers to world markets. At the same time, transparency in education and similar areas will allow citizens to get acquainted with the economic processes carried out by the government online. In our country, the development of the digital economy is aimed at creating new jobs, improving the living standards of the population, the development of digital e-government in Uzbekistan, the digitalization of financial services.

At the same time, various measures are being taken in the country to develop the digital economy. In particular, the Resolution of the President of the Republic of Uzbekistan dated July 3, 2018 "On the development of the digital economy in the Republic of Uzbekistan" and December 13, 2018 "On the development of digital economy, e-government and information systems This is evidenced by the adoption of the decree "On additional measures for the introduction of Based on the above decisions and decrees, you can see that the following measures are being taken.

- Development of blockchain technologies, which are the main techniques of the digital economy, and training of qualified personnel for their use;

- Creation of a legal framework for the use of blockchain technologies based on foreign technologies;

- Establishing cooperation with government agencies and organizations in the introduction of innovative technologies for the development of the digital economy.

Another example of the development of the digital economy is the Digital Economy Fund established in Uzbekistan. The Digital Economy Development Fund implements promising and strategically important projects for the development of the digital economy in a public-private partnership, including in the field of cryptocurrency and cryptocurrency exchanges, assists in the development and implementation of blockchain technology,

Blockchain is one of the key technologies in the digital economy, which allows system



participants to exchange assets directly and reliably. In our country, the Digital Trust Fund for Support of Digital Economy has been established, which is a state institution aimed at attracting and consolidating investors' funds for the development of the digital economy, in particular in connection with the introduction of blockchain technology.

In this regard, from January 1, 2021 in our country, "blockchain" technology will be used in the activities of government agencies, in particular, in cooperation with other government agencies and organizations, public procurement, public services,

implementation of data verification, ensuring the state's participation in the charter capital, the system of corporate governance of large commercial organizations, in particular, the improvement of business processes, optimization of production, administrative and operational processes, as well as the introduction of modern management and implementation for resource management.

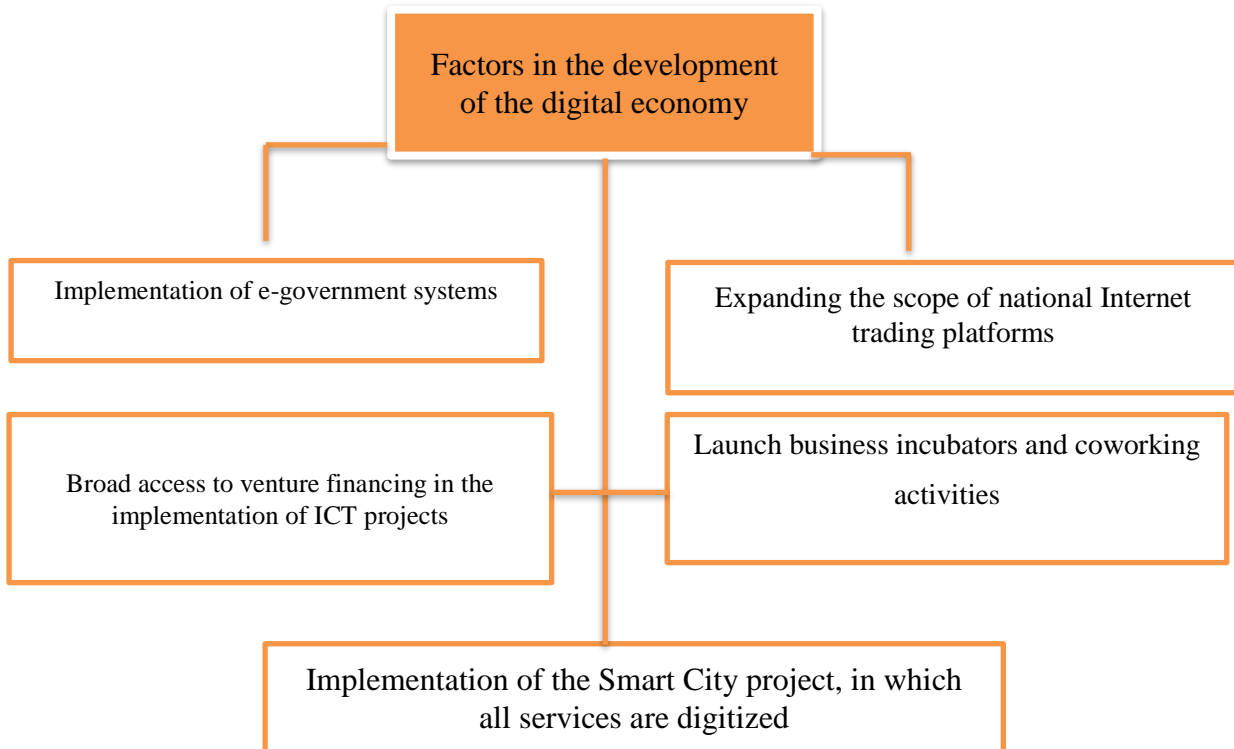
There are two ways to use blockchain in the digital economy, and both methods are currently being developed in our country. (Table 1)

Blockchain methods	Definition
Mass blockchain method	In this blockchain method, bitcoin cryptocurrency is widely used. In it, each participant will have the opportunity to read and write information.
Private blockchain method	It is based on the principle of limitation in writing and reading data. In this way, Participants can read and write only the part of the data that belongs to them.

**Table 1. Definition of blockchain methods**

The role of blockchain technology in the digital economy can be explained by the role of technology in business models based on it.

With the development of the digital economy in our country, the use of the following factors is of particular importance in increasing its development trends. (Fig. 1)



**Figure 1. Development factors of the digital economy**



As a result, we can say that the development of the digital economy is important for reducing the role of the state in the economy and improving the quality and transparency of public administration through digital electronic online platforms, creating a massive digital infrastructure for digital information technologies and electric transport, and ensuring innovative labor mobility. With the development of the digital economy in our country, we can create more favorable conditions for citizens, reduce long queues, surf the Internet, provide employment for citizens, and establish transparency and openness between the government and citizens.

## REFERENCES

1. S.S. Gulyamov, R.H. Ayupov, O.M. Abdullaev, G.R. Baltabaev "Blockchain technologies in the digital economy" textbook 2019. 400 pages.
2. Introduction to "Digital" economy under the general editor Keshelava A.V. Moscow 2017. 28 p.
3. Harbhajan S. KehalVarinder P. Singh. "Digital Economy: Impacts, Influences and Challenges" Published in the United States of America in 2005 year. 425 p.
4. Farxodjonqizi F. N., Dilshodjonugli N. S. Innovative processes and trends in the educational process in Uzbekistan //ACADEMICIA: An International Multidisciplinary Research Journal. – 2020. – T. 10. – №. 4. – C. 621-626.
5. Numonjonov S. D. Innovative methods of professional training //ISJ Theoretical & Applied Science, 01 (81). – 2020. – C. 747-750.



## DETERMINATION OF THE EFFICIENCY OF USING THE COOLING SYSTEM IN SOLAR PHOTOELECTRIC CONVERTERS

**S.F. Ergashev<sup>1</sup>**

<sup>1</sup>*Fergana Polytechnic Institute, Fergana, Uzbekistan*

**D.R.Otamirzaev<sup>2</sup>**

<sup>2</sup>*Namangan Engineering and Technology Institute, Namangan, Uzbekistan*

### ABSTRACT

*Industrial solar panels heat up to 75 °C in summer, which adversely affects efficiency and their lifespan. In this work, a method for increasing the efficiency of solar photovoltaic converters is experimentally studied. A cooling system has been developed and the dependence of the short-circuit current and open-circuit voltage of the solar panel on its surface temperature has been studied.*

**KEY WORDS:** *Solar photovoltaic converter, temperature dependence, cooling system, short circuit current, no-load voltage, temperature.*

## ОПРЕДЕЛЕНИЕ ЭФФЕКТИВНОСТИ ИСПОЛЬЗОВАНИЯ СИСТЕМЫ ОХЛАЖДЕНИЯ В СОЛНЕЧНЫХ ФОТОЭЛЕКТРИЧЕСКИХ ПРЕОБРАЗОВАТЕЛЯХ

**С.Ф.Эргашев<sup>1</sup>,**

<sup>1</sup>**Ферганский политехнический институт, Фергана, Узбекистан**

**Д.Р.Отамирзаев<sup>2</sup>**

<sup>2</sup>**Наманганский инженерно - технологический институт,  
Наманган, Узбекистан**

**Аннотация:** Промышленные солнечные панели в летнее время нагреваются до 75 °С, что неблагоприятно воздействует на эффективность и на их срока службы. В данной работе экспериментальным путем изучен метод повышения эффективности солнечных фотоэлектрических преобразователей. Разработана система охлаждения и изучена зависимость тока короткого замыкания и напряжения холостого хода солнечной панели от температуры ее поверхности.

**Ключевые слова:** Солнечный фотоэлектрический преобразователь, температурная зависимость, система охлаждения, ток короткого замыкания, напряжения холостого хода, температура.



## Введение

Энергетика имеет многочисленные отрасли в зависимости от основного энергоносителя: ядерная, угольная, газовая, гидроэнергетика и альтернативная, основанная на использовании нетрадиционных возобновляемых источников энергии. К альтернативной энергетике можно отнести ветроэнергетику, солнечную, геотермальную, энергию биомасс, приливно-волновую и т. д. Если сравнить все отрасли по экологическим, экономическим критериям и показателям безопасности, то можно прийти к выводу, что наиболее перспективной из них является солнечная энергетика [1].

Солнечный элемент - это электрическое устройство, которое преобразует энергия света непосредственно в электричество постоянного тока (DC) из за фотоэлектрического эффекта в них. Солнечные батареи в основном производятся из кремния, на сегодняшний день наиболее широко используется [2]. Одним из ведущих мировых производителей солнечных панелей с превосходным ассортиментом качественных, надежных и высокопроизводительных панелей является LG Energy [3]. Самый высокий КПД у солнечных панелей компании Canadian Solar 23.8 %. Компания Canadian Solar была основана в 2001 году в Канаде и в 2006 году превратилась в одного из крупнейших мировых производителей солнечных батарей и разработчиков проектов в сфере гелиоэнергетики [4]. Сегодня Canadian Solar имеет дочерние предприятия в более чем 24 странах на 6 континентах. Эффективность распространенных солнечных панелей в пределах 16-19%, из за такое низкого значения, учеными всего мира изучается способы повышение эффективности солнечных батарей.

"В Узбекистане в году более 320 солнечных дней. Если предположить возможность получения энергии от Солнца, то у нас есть реальные условия для использования солнечных лучей в течение практически всего года. То есть мы сможем получать энергию в объеме больше 182 миллионов тонн нефтяного эквивалента в год. Это почти в три раза больше объема энергии, потребляемой в стране в настоящее время. Солнце — самый оптимальный и эффективный источник энергии в Узбекистане" сказал заместитель министра энергетики Республики Узбекистан. Тем не менее в Наманганской области Республики Узбекистан на данный момент работают более двести насосных агрегатов которые потребляют около 35% электро энергию области [5]. Более 70% из них находятся в отдаленных местностях что приходится питать их многокилометровыми линиями

электропередач что требует дополнительных затрат на эксплуатацию линии и на потери в проводах [5]. Что бы решать эту проблему целесообразно использовать автономные солнечные электростанции.

## Пути повышения эффективности солнечных панелей

Из анализа Шокли и Кейссера, солнечный элемент с одним переходом имеет теоретический верхний предел эффективности преобразования около 33,7% в условии AM 1.5 [6]. Таким образом, в то время как солнечный элемент поглощает всего падающее солнечное излучение, значительная часть поглощенного солнечного излучения, которое не преобразуется в электричество, а вместо этого вырабатывает тепло что, в свою очередь, нагревает солнечный элемент [7]. На практике рабочая температура солнечного элемента в наружных условиях обычно составляет 55–6 °C и выше. Это тепло не благоприятно влияет на энергетические характеристики, надежность и эффективность солнечных панелей [8]. Для солнечных элементов из кристаллического кремния каждое повышение температуры на 1 K приводит к относительному снижению эффективности около 0,45% [9]. В условиях жаркого климата Узбекистана, температура поверхности солнечных панелей достигает 70 °C и выше что говорить об актуальности охлаждения для эффективной работы и долгой службы солнечной панели [10]. Кроме того, старения солнечного элемента в двое ускоряется при каждом увеличении его рабочей температуры на 10 K [11]. Поэтому существует острая необходимость разработать эффективные методы охлаждения солнечных элементов. Современные подходы включают теплопроводность поверхности [12], принудительный поток воздуха [13], образование горячей воды в комбинированные фотоэлектрические / тепловые системы [10], тепловые системы на основе труб [14]. В работе [11] изучено радиационное охлаждение солнечных панелей путем покрытия их поверхности стеклом миниатюрными пирамида образными формами, изучены зависимости характеристик элемента.

## Экспериментальная работа

В этой работе мы предлагаем использование жидкостного охлаждения для снижения температуру работающих солнечных батарей под прямыми солнечными лучами. Основная идея заключается в том, что ёмкость через теплопроводящий слой прикреплен к солнечной панели. Такой способ охлаждения не ухудшает оптический производительность солнечного элемента, но отводит значительное





тепловое излучение, которое приводит к охлаждению солнечного элемента, передавая тепло к жидкости.

Рассмотрим влияние показателя температуры на эффективность на примере солнечных батарей.

ELECTRICAL CHARACTERISTICS AT NOCT **							
Module Type	LDK	275 MA	270 MA	265 MA	260 MA	255 MA	250 MA
Output Power (Pmax)	[W]	199	196	192	189	185	181
Voltage at Pmax (Vmp)	[V]	28.9	28.6	28.2	27.8	27.4	27.0
Current at Pmax (Imp)	[A]	6.89	6.86	6.82	6.78	6.74	6.70
Open Circuit Voltage (Voc)	[V]	36.0	35.8	35.6	35.3	35.1	34.8
Short Circuit Current (Isc)	[A]	7.3	7.28	7.27	7.25	7.24	7.23

NOCT\*\* (Nominal Operating Cell Temperature): Irradiance 800 W/m<sup>2</sup>, Ambient Temperature 20 °C, Wind speed 1 m/s  
Test in Class AAA solar simulator (IEC 60904-9) is used, with power measurement uncertainty within ± 3%.

TEMPERATURE CHARACTERISTICS	
NOCT	45 ± 2 °C
Pmax Temperature Coefficient (γ)	- 0.47 %/°C
Voc Temperature Coefficient (β)	- 0.34 %/°C
Isc Temperature Coefficient (α)	0.06 %/°C
Series Fuse Maximum Rating	15 A
Operating Temperature	From - 40 to +85 °C
Storage Temperature	From - 40 to +60 °C

Рис - 1

Из рис 1. Видно что, повышением температуры на 1 °C напряжение холостого хода уменьшается на 0.34%. и это можно записать в виде:

$$U_{oc,\tau} = U_{oc}(1 - 0.0034(\tau - 25)) \quad (1)$$

Где:  $U_{oc,\tau}$  – напряжение холостого хода при температуре  $\tau$ .

$U_{oc}$  – напряжение холостого хода при температуре 25 °C.

$\tau$  – температура поверхности солнечной батареи.

Также зависимость тока короткого замыкания от температуры запишем:

$$I_{sc,\tau} = I_{sc}(1 + 0.0006(\tau - 25)) \quad (2)$$

Где:  $I_{sc,\tau}$  – ток короткого замыкания при температуре  $\tau$ .

$I_{sc}$  – ток короткого замыкания при температуре 25 °C.

$\tau$  – температура поверхности солнечной батареи.

Реальный коэффициент полезного действия солнечных панелей используемых в условиях жаркого климата таких как Узбекистан имеет вид:

$$\eta = \frac{I_{sc,\tau} U_{oc,\tau}}{P_{in}} \quad (3)$$

Где:  $\eta$  – коэффициент полезного действия.

$P_{in}$  – падающий на солнечный панель солнечное излучение.

Для проведения эксперимента была выбрана солнечная панель из поликристаллического кремния марки AS-100P компании All-solar Китай. На тыльную сторону панели через теплопроводящий гель прикреплена система охлаждения, она представляет собой два алюминиевого листа между которыми по краям прямоугольный профиль имеющий два штуцера для входа и выхода теплоносителя. Полость между стенками играет роль емкости теплоносителя. Эксперименты были проведены в условиях натурального освещения на открытой лаборатории Наманганского инженерно технологического института в городе Наманган Республики Узбекистан с 04.05. по 14.05. 2020 года. На рис. 2 схематически изображен разрез экспериментальной установки в форме прямоугольного параллелепипеда плоскостью, проходящей параллельно плоскостям длинных боковых стенок: на рис. 3 – разрез фотоэлектрического преобразователя плоскостью, проходящей параллельно плоскостям коротких боковых стенок.

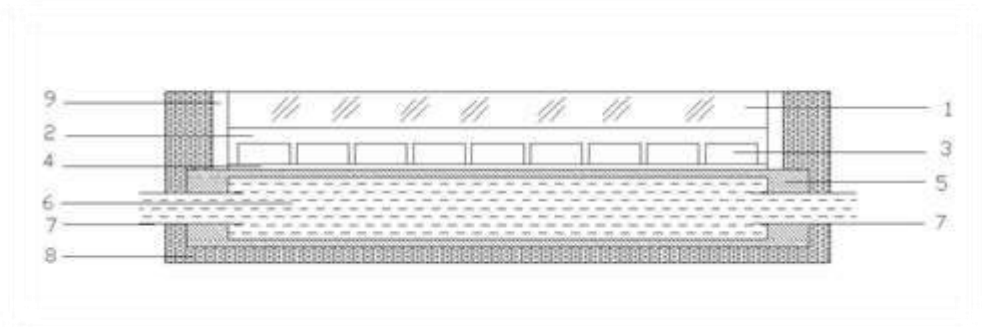


Рис - 2

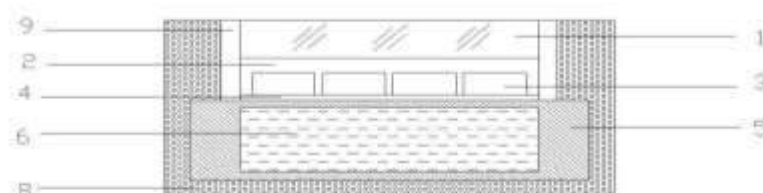


Рис - 3

1-стекляное покрытие, 2-герметизирующий слой, 3-фотоэлементы, 4-теплопроводящая паста, 5-корпус системы охлаждения, 6-теплоноситель, 7-штуцера для входа и выхода теплоносителя, 8-теплоизоляционный слой, 9-уплотнитель.

Экспериментальная установка имеет следующие размеры: длина 1100 мм, ширина 760 мм, толщина 50 мм. Установка имеет 36 фотоэлектрических ячеек общей мощностью 100 Вт. Технические характеристики приведены в таблице 1.

Таблица 1.

Номинальная максимальная мощность	100 W
Напряжения при P <sub>max</sub>	17 V
Ток при P <sub>max</sub>	5.7 A
Напряжения холостого хода	21.5 V
Ток короткого замыкания	5.8 A

Для проведения эксперимента выбирались ясные солнечные дни. Мощность солнечного излучения 1000 W/m<sup>2</sup>.

Для получение данных установка было ориентирована на солнцу под прямым углом. Через систему охлаждения подавалась вода

температурой 16 °С. Расход воды составлял 3-3,5 литров в минуту. Для измерения электрических параметров солнечной панели использовался измеритель МЕТРАНИТ TRMS professional PRO. Результаты измерений приведены в таблице 2.

Таблица 2.

Время измерения	Температура поверхности (°C)	Ток короткого замыкания (A)	Напряжения холостого хода (В)
04.05.2020	26	5.75	21.8
07.05.2020	25	5.72	21.9
10.05.2020	25	5.7	21.9
13.05.2020	24	5.7	22

**Заключение**

Из вышеизложенной работы и полученных результатов можно сделать следующие выводы:

- Из формулы (3) получим что, использование солнечных фотоэлектрических панелей в жарких регионах приводит к

уменьшению КПД и что его можно предотвращать путем отвода тепла с тыльной стороны панелей.

- Использование систем охлаждения существенно увеличивает КПД и срок службы солнечных панелей.



• Показано что, установка системой охлаждения более устойчива к механическим повреждениям

• Установлено что, использование солнечных электростанций системой охлаждения для энергоснабжения отдаленных насосных станций, оптимальным решением проблем энергоснабжения и минимизирует потери в линиях насосной станции.

• Разработанная установка демонстрирует свою эффективность в сельском и рыбном хозяйстве.

### Литература

1. "Геофизические процессы, солнечная энергия и биосфера как системные факторы эволюции Земли," ГЕОФИЗИЧЕСКИЕ ПРОЦЕССЫ И БИОСФЕРА, 2017, doi: 10.21455/gpb2017.3-6.
2. T. Pavlovic, "Solar energy," in *Green Energy and Technology*, 2020.
3. M. Kazici et al., "Solar Cells," in *Comprehensive Energy Systems*, 2018.
4. M. Jørgensen et al., "The state of organic solar cells - A meta analysis," *Sol. Energy Mater. Sol. Cells*, 2013, doi: 10.1016/j.solmat.2013.05.034.
5. J. Servet, C. Tiangco, A. López, I. De Loizaga, D. Castilla, and R. Pérez, "Roadmap for solar energy development in Uzbekistan," in *Energy Procedia*, 2014, doi: 10.1016/j.egypro.2014.03.202.
6. S. Joshi and G. Moddel, "Efficiency limits of rectenna solar cells: Theory of broadband photon-assisted tunneling," *Appl. Phys. Lett.*, 2013, doi: 10.1063/1.4793425.
7. M. Rosa-Clot, P. Rosa-Clot, G. M. Tina, and P. F. Scandura, "Submerged photovoltaic solar panel: SP2," *Renew. Energy*, 2010, doi: 10.1016/j.renene.2009.10.023.
8. H. Helmers, M. Schachtner, and A. W. Bett, "Influence of temperature and irradiance on triple-junction solar subcells," *Sol. Energy Mater. Sol. Cells*, 2013, doi: 10.1016/j.solmat.2013.03.039.
9. E. Skoplaki and J. A. Palyvos, "On the temperature dependence of photovoltaic module electrical performance: A review of efficiency/power correlations," *Sol. Energy*, 2009, doi: 10.1016/j.solener.2008.10.008.
10. O. D.R., "Energy characteristics of solar photoelectric installations under the combined production of heat and electric energy in the conditions of uzbekistan," *Int. J. Psychosoc. Rehabil.*, vol. 24, no. 04, pp. 1836–1842, Feb. 2020, doi: 10.37200/IJPR/V24I4/PR201291.
11. L. Zhu, A. Raman, K. X. Wang, M. A. Anoma, and S. Fan, "Radiative cooling of solar cells," *Optica*, 2014, doi: 10.1364/optica.1.000032.
12. D. M. Tobnaghi, R. Madatov, and D. Naderi, "The Effect of Temperature on Electrical Parameters of Solar Cells," 2007.
13. A. Shukla, K. Kant, A. Sharma, and P. H. Biwole, "Cooling methodologies of photovoltaic module

for enhancing electrical efficiency: A review," *Sol. Energy Mater. Sol. Cells*, 2017, doi: 10.1016/j.solmat.2016.10.047.

14. J. Siecker, K. Kusakana, and B. P. Numbi, "A review of solar photovoltaic systems cooling technologies," *Renewable and Sustainable Energy Reviews*, 2017, doi: 10.1016/j.rser.2017.05.053.



# THE PROBLEMS OF USING THE CASE-STUDY METHOD IN THE STUDY OF SOCIAL PROBLEMS OF CHILDREN WITH DEFICIENT MENTAL DEVELOPMENT

**F.O.Kamilov**

*Chief Specialist of the Republican Center for social adaptation of children*

## ANNOTATION

*The article reviews the literature reflecting the scientific - theoretical study of the concepts of "mental weakness", "case-study" and scientific works of foreign and domestic scientists who conducted scientific research in this regard. The role and importance of case - study method in the study of social problems of children with mental development deficient is revealed. The author drew the main attention to theoretical and methodological approaches to the method of case study in the system of social sciences. It also comprehensively revealed the methodological problems of the case study method (general assumptions, selection, justification, generalization of the research work) in the study of the processes of social adaptation of children with disabilities in their mental development.*

**KEYWORDS:** *mental weakness, pedagogical neglect, social adaptation, social work models, research methodology, case study, in - depth interview, focus group.*

## DISCUSSION

Pollution of the environment, various diseases encountered by parents, a number of socio-economic, psychological, pedagogical and medical problems that must be solved lead to an increase in the number of children with disabilities, in particular, with defects in mental and mental development.

According to the World Health Organization, 15 percent of the Earth's population suffers from disability, of which children with disabilities in mental development account for 2,5-3,0 % of the total population.

At present, a certain base of scientific and theoretical approaches to the effective socialization of children with disabilities in the intellectual development of philosophy, pedagogy, psychology, law, medicine, sociological sciences has been formed. But at the same time, in modern sociology, the issues of social adaptation of children with a deficiency in mental development to society are poorly studied. We can see that in correctional pedagogy and special psychology, the issues of education and upbringing of children with defects in mental development are studied in detail.

The correct definition of the concept of "mental weakness" is of great practical importance

for the correct understanding of its causes. In the international classification of diseases (MKB-10), mental weakness is described as follows: "mental weakness is a state in which the psyche is left behind or developed incorrectly, which is characterized primarily by a violation of the abilities manifested during the period of development, and is a state of psyche that provides a general level of intelligence, that is, the development of cognitive, speech, motor. In this case, mental weakness is a state that is not the same; it has many causes associated with developmental disorders and has been emphasized to lead to disorders associated with cognitive functioning and social adaptation. The level of mental weakness is usually assessed using tests that determine the patient's condition. The level of mental weakness is filled with scales that assess social adaptation in the environment. According to the international classification of 10 revised diseases of the World Health Organization, the following levels of mental weakness are distinguished: F70—mild mental weakness, F71 – moderate mental weakness, F72 - severe mental weakness, F73-deep mental weakness[1].

After 1950 years the basis of a deeper, creative study of I.P.Pavlov's teaching, a narrow



understanding of mental weakness was put an end. On the basis of this doctrine, the essence of the "protector-keeper" process was revealed. The reflexive theory of the psyche clarified the violation of the ability to work as a result of the disease of the central nervous system. Children with mental weakness have a higher nervous activity characteristics the scientific work carried out by A.R.Loriya, M.S.Pevzner will have great theoretical significance. The International Council in 1962 year helped to correctly analyze the philosophical issues of the physiology of higher nervous activity.

Famous psychologist L.S.Vigotsky the teaching of was of great theoretical, practical importance. Currently the teaching of L.S.Vigotsky is becoming more relevant. Studies are being developed to involve children with disabilities in their mental development on the basis of various etymological factors in differentiated education[2].

In his work L.S.Vigotsky "Development diagnostics and pedagogical clinic of difficult childhood", published in 1936 year, gives the following opinion: "the longer the symptom lasts from the primary defect, the easier it is given to upbringing, treatment." This indicates separately that early detection of developmental defects in the arm is significant. Significant scientific work on the problem falls on the activities of M.S.Pevzner and V.I.Lubovsky. They showed effective periods in the mental development of mentally retarded children in their fundamental works called "the dynamics of the development of Oligophrene children" in 1963 year on the basis of their long-standing observations.

Foreign scientists have also studied the impact of education on mental development of mentally retarded children in specific areas. A.D.Clark acknowledged that education has not effectively affected the mental development of mentally retarded children. The author offers mainly a method of exercise when working with mentally retarded children. French scientist Clod Coler, however, recommends that more finger exercises should be used in mental development[2].

The expression "mentally weakness" is not used at the moment. In the development of reason, the phrase children with defects is used more often. In recent years, when explaining the essence of mental weakness, it is customary to show that it is not certain mental disorders, but a violation of behavior that arises on the basis of the inability to develop abilities. On the basis, expressions such as children without pedagogical care, children behind in mental development, children violating the norms of law are also included. According to experts, with children with a mild degree of mental weakness (F70 – mild mental weakness), it is possible to change the

dynamics of intellectual ability and social adaptation if they are engaged and rehabilitated on the basis of timely practical exercises, and the diagnosis of mental weakness can be removed.

The issues of social adaptation, development, education of mentally retarded children to society have been thoroughly studied in correctional pedagogy and special psychology. To a thorough study of this problem Vlasova T.A., Pevzner M.S., Lubovsky V.I., Lebedinskaya K.S., Shoumarov G.B., Mamedov K.K. and others have contributed effectively [3,4]. From pedagogical scientists L.R.Muminova, D.Nurkeldieva or Ya.E.Chicherinas studied the issue of the establishment of a first aid service for children with special needs[5,6,7], in national sociology and social work M.X.Ganieva, N.M.Latipova, A.A.Abdukhalilov's scientific activities include social work with children with disabilities, issues of social protection and support [8,9,10].

The issue of systematic study of the issues of social adaptation of children with disabilities in the development of reason in modern sociology is one of the topics to be studied as an object of separate research. In sociology, there are many research methods in the sociological analysis of a single social problem. The most common of them are survey (questionnaire, interview), expert survey, observation, focus group etc. However, the practice of studying one situation (phenomenon)separately as a whole has not yet gained popularity in Uzbekistan. In world experience, this method is called case-study.

In the study and analysis of social problems of children with mental development deficiency, the use of case - study method is important. The method of case-study was developed by well-known pedagogical scientists at Harvard University (USA) in the 20-30-ies of the XX century[11]. The method of case study is widely used in the practice of teaching social sciences, as well as legal and Economic Sciences. Case-study is not a large-scale statistical study, but an in-depth study of a particular situation. In recent years, applied research has evolved as a useful tool for studying trends and specific situations in many scientific disciplines. This method was especially widely used in social sciences, psychology, anthropology and ecology. Case-study is also useful for testing theoretical models that should be used in real situations. For example, this method can be used when testing ecosystem models of social work.

Case-study (case-study - from English) is a research method that allows you to study individual facts, phenomena or examples in a specific context as well as to obtain specific evidence[11].





This research method is aimed at a thorough and in-depth study of the social situation and problems of a particular set of case (situation, fact or phenomenon) or multiple case. Case can be understood by individuals, organizations, the public, events or processes. The composition of case is clarified during the collection of data and their analysis.

Case-study real life is a concrete situation and the environment that surrounds it, as well as the relationship between them, conventionally analyzes and studies. The case-study method is also described as an empirical study that studies a particular situation using concrete evidence and fact in the real context. The study of case allows you to learn and understand complex problems.

Especially when a holistic in-depth analysis of the problem is necessary, it can be considered a reliable method of research. The study of a particular single or multiple case allows the researcher to thoroughly study the data in a given context. The study of case will enable the researcher to deviate from quantitative statistical results and to understand behavioral conditions from the point of view of the subject. The fact that the issue of quantitative and qualitative processing and data collection remain aside worries the researchers. Both quantities allow for full clarity of the situation by studying and analyzing the case, including quality information.

Basics of selecting case to conduct the study.

The choice of case for carrying out the study will be determined based on the research strategy. If the casings under consideration on the subject matter constitute a drawback, random selection is not the right solution. Under these circumstances, targeted sorting is necessary. In most cases, targeted selection of case is used when using the case - study method. If the research objectives focus on in-depth analysis of the situation rather than on forecasting, the choice of the study participants will focus on individuals who are catalysts of conversation on their life situations and problems. Conducting conversations with close relatives (grandfather, grandmother, uncle, mountain, aunt, Emma), aries, class leader, educator will help in obtaining reliable and accurate information for a while, especially in the study of case to the situation of children who have a deficiency in their mental development, play an important role in the life of the child, either the parents or the parents of the child, or however, when choosing case, the final choice should focus on a particular problem, and the number of case should be limited. In the case-study method, there may be observations, conversations, documents related to the person, press articles, reviews, source of information provided by various social

institutions. Case-study method traditional qualitative research consists of a focus group, a deepened interview, usually involving one or more case. Unlike other research method, the method of studying case collects more information about each case based on interviews conducted with several stakeholders involved in a particular case.

Conducting an in - depth interview between children with disabilities in their mental development and their loved ones using the case study method is also critical in collecting analytical data.

Deepened interview.

An in-depth interview is a voluntary conversation between these two people, one is an interviewer who is involved in this situation as a professional researcher and she performs the role of interviewer. Quality interview technology will vary based on research objectives. All of them are part of the methods of deepening (unstructured or semi-structured) and take at least 1,5-2 hours.

In the case-study method, the work requires a thorough organization of the study of the situation, starting with the selection of case. Usually, the number of case should be up to 4-10 soles. For example, when choosing case, it is possible to obtain an equal number of successful case and unsuccessful case. In this case, contrast makes it easier to identify success factors in the report.

In the case-study method, interviews or focus groups are organized with several individuals. The study of case and the collection of data is carried out for 2-4 weeks, depending on the complexity of the case.

By its nature, case-study is inclusive, that is, it covers a whole circle of all processes involved in the problem. When conducting sociological studies among mentally retarded children, the situation of each child is studied individually, using the case - study method.

Conclusion. The case study method as a research method is used in a number of disciplines to obtain extensive coverage and in-depth data on the analysis of problems affecting the social life of the society. Although in some areas there are specific features, differences, the general aspects are obvious. With the possibility of adapting individual approaches in the study of a particular issue, a case study can cover questions that address the causes and solution of the problem. The case study method helps the researcher to investigate, explain, characterize, evaluate and scientifically-theoretical justification of complex problems. The findings of the study will lead to a deeper understanding of the behaviours and behaviors of children with developmental disabilities, the processes of social adaptation and the attitudes of society towards such children. The method of case-



study is widely used in the practice of teaching social sciences, education, health, law, management Sciences.

## REFERENCES

1. Всемирная организация здравоохранения. Международная статистическая классификация болезней и проблем, связанных со здоровьем. Десятый пересмотр (МКБ-10). Швейцария-2016.
2. Выготский Л.С., Лурия А.Р. Этюды по истории поведения. Обезьяна. Примитив. Ребенок. – М.: «Педагогика-Пресс», 1993.
3. Мамедов К., Шоумаров Г. Ақли заиф болалар психологияси. Тошкент, 1994.
4. Рубинштейн С.Я. Психология умственно отсталого школьника., М., 1986,
5. Муминова Л.Р. Социальная защита детей в Узбекистане: наука и практик: монографический сборник. –Ташкент: Spectrum Media Group, 2015. – 252 с.
6. Д.А. Нуркелдиева, Я.Е. Чичерина. Илк мактабгача ва кичик мактаб ёшидаги болаларни психологик-педагогик, логопедик текишириши. Псих.фан.док., проф. Ф.Б. Шоумаров тахрири остида. Тошкент- 2007
7. Чичерина Я.Е., Может ли Дом ребенка заменить семью? Журнал «Бола ва замон» №1, 2018 й.
8. Ганиева М.Х. Социальное сопровождение ребёнка с особыми потребностями. Организация оказания социальной помощи с участием ближайшего окружения семьи. Ташкент: РЦСАД, 2016.-76 с.
9. Ганиева М.Х., Латипова Н.М., Алексеева В.С. Социальное обеспечение и защита детей и молодежи. Учебное пособие. – Ташкент: Yangi Nashr, 2017.
10. Абдухалилов А.А. Вопросы совершенствования социальной защиты лиц с инвалидностью в процессе государственного управления. Материалы международной конференции «Социальная защита детей в Узбекистане: передовой отечественный и зарубежный опыт» Тошкент-2018, 20 б.
11. Хачатрян М.Э. Проведение исследования методом изучения кейса в организациях. – Текст: непосредственный //Молодой ученый. – 2018.-№49(235)-с 400-403.



# **SOCIAL STRATIFICATION OF PEASANT FARMS IN UZBEKISTAN IN THE FIRST YEARS OF THE NEW ECONOMIC POLICY**

**Mahmudov Mahmudkhon**

*Teacher, Department of Social Science, Andijan State Medical Institute*

## **ANNOTATION**

*This article covers the introduction of a new economic policy (NEP) in Turkistan ASSR and the issue of conflicts and complexities in the early years. In the conditions of the new economic policy, the processes of social stratification of Uzbek peasant farms and its peculiarities are analyzed.*

**KEYWORDS:** *new economic policy, Turkistan Assr, Uzbekistan SSR, peasant farms, credit, credit companies, food tax, rural dwellers, judiciary, rent, conservatism, cooperative.*

## **DISCUSSION**

After the national-territorial border in 1924, a new stage of agrarian changes began in Uzbekistan. In 1924-1925, 85 percent of the population of the country's labor - worthy population was employed in agriculture. The impact of agrarian sector products was almost 80 percent of the total gross output. 90 percent of the industry was engaged in the processing of agricultural raw materials. In such conditions, the conduct of Agrarian Reform was of deep social importance.

The land-water reform conducted in 1921-1922 years did not fully resolve the issue of landless and low-income peasants and the distribution of existing lands. This reform was mainly aimed at the issue of strengthening the lands at the disposal of local peasants with Russian peasants, who were transplanted into the country during the Tsarist Russia. Simply put, the agrarian reform of 1921-1922 years ended the foundations of colonial procedures of Tsarist Russia. However, the country continued to preserve much land and little land.

By the middle of the 20-ies of the XX century, a little moving were achieved in the socio-economic situation of the Uzbek villages. The reason was that in connection with the transition to a new economic policy (NEP), farmers were breathing freely. The replacement of food razvyorstka with food taxes, the restoration of some marketplaces allowed rural workers to sell their own surplus

products, increase agricultural crops. As a result, the supply of goods to peasant farms increased, the standard of living of the population rose slightly.

Other means of economic stimulus were also used in ensuring the growth of agriculture, which consisted in the introduction of a fixed currency, the establishment of a new order of lending, the expansion of lending by the state to farmers, the definition of benefits, the escalation of agricultural cooperation [1.184].

Tax affairs were regulated and began to pass from the food tax of a different appearance to a single agricultural tax. In the middle of 1923, decisions were made to reduce the size of the single agricultural tax from peasant farms in the Fergana region by half, complete exemption of small livestock farms from taxation and 50 percent reduction of the amount of taxes imposed on slightly larger farms. It was recognized that private and economic activities have different forms of rent, yollash, such as mergers and hocas to artels [2.269].

Attention was paid to the provision of cotton farms with goods, they were allowed to use hired labor, they were provided with water in the first place, a large part of the cotton farms were exempted from the horse-breeding tax, the food tax of low-income farms. This highly effective price policy and its full supply of goods had a positive impact on the mood of the farmers, their desire to grow more cotton. Only in 1924-1926 it was not surprising that



the cotton-growing area in the Republic increased by 31.6 percent [3.77].

In these years, the cooperative movement took a leading position in agriculture. In the early years of the new economic policy, credit cooperations were much more common in the Autonomous Republic of Turkistan and they gained a great reputation among peasant farms. Because, in the Uzbek villages, the need for low-power farmers to borrow money from their cash accounts was very large, and the main place in the villages was rich-judicial and commercial capital. In 1921-1922, 85-90 percent of the farmers borrowed from rich-landlords, granting of state loans had covered 15-20 percent of the farmers' farms, they were not able to pay the farmers' debts. In the conditions of the new economic policy, the provision of credit by the state and cooperatives of low-power farmers and, in general, farms engaged in agricultural production is significantly improved.

The idea of economic promotion of the individual peasant economy as a producer of small goods was manifested as an idea that determined in the development of specific measures to remove irrigation, cotton, horticulture, viticulture, cattle breeding from degradation, increase in the volume of products, as well as in the revival of commodity exchange between industry and agricultural production [5.21].

In October 1923, there were 314 credit companies in Turkistan, which united almost 58 thousand peasant farms. In particular, he was a member of 23000 peasant credit companies in the Sirdarya region, 16000 in the Fergana region, 8000 in the Samarkand region, 9 000 in the Zakaspy region and 2000 peasant credit companies in the Ettisuv region [6.179]. By the end of 1924, the agricultural credit companies of Turkistan reached 912 units, they merged into 18 units of the district union, while the members of these companies reached 233 thousand 500 people [7.20-28].

However, it should also be noted that in addition to success in the cooperative movement, its capabilities are not fully utilized. This was also partly due to the ideology of the economy. They were evident in matters of granting loans and accepting members to cooperatives. He would not have accepted anyone into the cooperative. Classifical there was a choice. The poor were given priority.

In the conditions of socio-economic backwardness of the republics of Central Asia, the issues of granting and using of permission to the activities of private capital have become complicated. With the introduction of a new economic policy, private capital in Turkistan Assr has become widespread, mainly in trade and small-scale industries, as well as in the field of debt and credit. In

the first period of NEP, the gross share of private capital in Turkistan was much higher in all sectors of the economy than in other regions. This is explained by the fact that the socialist ukland in the republics of Central Asia is much weaker, feudal-patriarchal relations in the country are preserved. In the Central Asian republics, 67 percent of the retail trade turnover in 1925-1926 was owned by private capital, while in the union the figure was 40,7 percent [8.101-102]. In the trade in rural areas, the salinity of private capital was even higher. For example, in the Samarkand region in 1925, private capital occupied 90 percent of retail trade turnover in rural areas. In 1926, more than 34 percent of the total amount of loans received by farmers in some Pakhtakor districts fell to the private equity index [9.81]. According to the inspections conducted by the Agricultural Bank of the USSR of Uzbekistan, 316 or 52.3 percent of 604 peasant farms studied in 1925-1926 in 7 villages in the Asaka district of Fergana region received loans from private persons for conducting economic activities [10.11].

Despite the silences in the agrarian sector a little earlier, the main issues related to the restoration of Agriculture have not yet been resolved, the situation remains complicated. In 1924, the lands used in agriculture accounted for only 58.7 percent of the existing crop areas in the Republic, while the gross agricultural output was 47.2 percent of the level in 1913 [11.15].

One of the priority factors in raising the rural economy was the escalation of large-scale agrarian reform at that time. The need for its implementation was interrupted by the problems that arose. Because, in the country, there was still a desolation. By 1925 year, 13 of every 100 farms did not have land to be sown. Landless and up to 2 desyatina landless farms accounted for 71,8 percent [3.84]. During this period, poor peasants in the Uzbek village formed the majority of the population. In 1925, the middle-class peasants were 2-3 times less than the low-class peasants. In 1926 year in Zarafshan and Ferghana regions, 52 percent of the farm had little land than a desyatina. Farms with less than 2 desyatina land in Zarafshan region accounted for 54 percent, and 42 percent in Tashkent and Samarkand regions [12.1].

It was also distinguished by the fact that the villages of Uzbekistan were divided into specific tiny and small land plots. The small peasant farms were concentrated mainly in small areas, which were irrigated from time immemorial, more in the Fergana Valley, Tashkent, Zarafshan and Khorezm regions. 25 percent of the land plots belonging to peasant farms in the Fergana Valley were located in the army villages. Half of these lands were in the territory of other volost villages. In the Zarafshan region, on



average, one farm had 2.5 land plots, in Khorezm an average of 1.5 land plots. Such a form of land ownership also caused certain difficulties. Because, peasant farms he went to the end land in the village, or went to the land in this village, and the peasant could take most of their time. It would have been an additional strain on the peasants, especially when watering the crops or plowing the land. The fact that the land plots were located without such a slope created the conditions for such tiny lands to eventually accumulate in the hands of some wealthy people. Because, in most cases, it is from the village that the peasants, who are tired of participating in this village, would have to send their plots to the rich cheaper-to buy collateral [11.37-38].

The fact that farming was based on more irrigation also caused certain complexities. In Fergana, Tashkent, Zarafshan, Khorezm regions, almost all agricultural lands were irrigated lands. The irrigated lands in the Surkhandarya region were 67.6 percent, in the Samarkand region 67.4 percent, in the Kashkadarya region 59.3 percent. Irrigated lands by the Republic accounted for 87 percent of all crop areas. Watering peasants were obliged to spend a lot of labor and money from farms. Because, such work as regular cleaning of irrigation networks, that is, ditches and channels, building dams where necessary, repairing them, required a very large workforce [13.59].

Analysis of the social structure of farms shows that on the eve of the second land reform in Uzbekistan more than 30 percent of fertile land was under the "rich kulaklar". However, ear and tiny helper farms in the Fergana region were 39 percent owned by land. In the Samarkand region, 32,7 percent of all lands were in the hands of ears and tiny pomeshchiks. The situation in other regions was similar in appearance [14.32].

The economic relations between the landowners were built on the basis of rent. Low income peasants, landowners and herdsman used to rent land and working weapons. That is, during this period 2 desyatina farms with land were also forced to acquire additional rented land [3.85].

In the agricultural regions of Uzbekistan, especially the Fergana region, where cotton is sown, Khujand, Mirzachul, Payarik, Damarik, Gijduvan and some other district rental relations were highly developed. Sharebay rentals were common, and this was especially the predominance in the Ferghana region. In this region, peasants with a land of up to 3 desyatina were usually forced to rent a share from large landowners. At the same time, farms with a check land of more than 7 desyatina were giving land for rent [15.121].

In 1925, 80 percent of lands were leased in Samarkand, Tashkent and Fergana regions. Large

landowners living in villages rent 95 percent of their land, and merchants living in cities rent almost all land to landless or low-income peasants. This case was evaluated in his time as "earning without labor", "exploitation of poor peasants by rich-ears".

The majority of landowners for rent were low - income peasants. If 78.5 percent of the farmers receiving land for rent in Kitab district of Kashkadarya region were farms with a land of up to 1.3 desyatina, 59 percent of the tenants of Khorezm region had land of up to 2 desyatina [16.5].

In all regions of Uzbekistan, the majority of poor peasants and low-power middle-class peasants could rent land, horses and equipment. According to statistical analysis in 1925 year, in this year 29,2 percent of peasant farms in the Republic were deprived of working animals. In terms of regions, this situation was as follows: 45.6 percent in Fergana region, 27.5 percent in Samarkand region, 26.4 percent in Tashkent region, 13.8 percent in Khorezm region, 7.7 percent in Kashkadarya region, 7.2 percent in Zarafshan region without working animals [17.36-56]. Apparently, non-animal farms of work made up the majority, mainly in the regions where cotton is grown. One of the reasons for this is explained by the difficulty in providing forage for working animals in peasant farms, as cotton is sown mainly on the ground in the cotton-growing regions.

In 1925 year, the main part of the working animals was collected in the hands of certain strata of people, that is, in the hands of large landowners. In these years, more than 10 percent of farms with more than 50 desyatina land have more than 4-5 working animals [17.56].

At the disposal of "helper-rich" farms, along with working animals, a large part of agricultural equipment was also collected. On the eve of the land-water reform, the main agricultural instruments in the Republic were plow, hoe, sickle and trowel. Even these simple agricultural tools were not even in many peasant farms. For example, according to the analysis in 1925, non-farm in Samarkand region accounted for 54.8 percent, in Tashkent region 43.6 percent, in Fergana region 35.2 percent, in Zarafshan region 12 percent. In some places, these percentages were even more numerous. For example, in the village of Tulkiabad in Balikchi district of Fergana region, 91,2 percent of farms without plow, 76,3 percent in the village of Kumtepa and 66,4 percent in the village of Khujaabad [18.33].

Farms without agricultural tools also rented the necessary tools. 25 percent of all peasant farms in Samarkand, Tashkent, Fergana and Khorezm regions used agricultural equipment for rent. The terms of rent were in different views, that is, to give a certain part of the crop grown for the use to the owner of the





instrument, or to produce on the land of the owner of the instrument, etc.

As can be seen from the above information, on the eve of the land-water reform, a large part of the peasant farms in Uzbekistan were either landless or low-income, as well as in need of working animals and working weapons. They are those who are forced to rent these things, in the end, the Tsarist relations in the Republic are widely spread.

The herdsmen rented a certain piece of land from the landowner, to which he received a certain agreed portion of the dressing, which he had harvested and grown, processing it with his own power, work animal and equipment.

Some herdsmen also rented a land-based business animal, work weapons and accommodation. In such cases, the choricor has left only a quarter of the grown crop. The main part of the harvest remained in the hands of the landowner. In 1923-1925, the government developed laws on the restriction of domestic Tsarist relations to some extent. During this period, the part of the cultivated crop that touched the choricors was increased. If in 1915 51,6 percent of the landowners gave half of the landowners, then in 1925 the amount of such landowners decreased by 31.5 percent [14.78]. But despite this, the poverty of the living standards of the choricors was still preserved. The crop that remains at the disposal of the choricors was in most cases not done for their needs. Under such conditions, they would be stuck in debt.

The state did not have the opportunity to provide loans to all peasant farms, as well as herdsmen during this period. Therefore, peasants in need of money received money mainly from rich-poor people in debt for severe conditions evasion. In the villages there were loan defendants to those in need. In 1925-1926, 52.3 percent of farmers in Asaka district of Fergana region borrowed money from private individuals. Farmers have paid a very large percentage of the debt they have received. The percentage of debts is from 120 to 225 percent in some parts of Uzbekistan [19.214]. The terms of the natural loan taken from private individuals were even more severe.

Well, the wide spread of Tsarist relations was hindering the development of agriculture. This was one of the problems that should be solved in the agrarian sector of the country.

As for 1925 in Uzbekistan, along with the issue of land, the problem of increasing the fertility of agriculture was also acute. Insufficient development of productive forces, low efficiency of agrarian production, the predominance of feudal-patriarchal forms in production relations hindered the processes of economic growth, the increase in the material well-being of the urban and rural population.

In general, the authorities of the Bolsheviks in Uzbekistan, as at the initial stage of agrarian reforms, in 1925-1929, initially denied the historically tested economic means of social reconstruction of the village, the important experience of resolving the issue of peasants in the "capitalist countries". The Bolshevik leaders of the communist metropolis chose violence as the main weapon of rebuilding socio-economic relations, relying on the fantastic beliefs of marxism. Because although the new economic policy somewhat softened the methods inherent in the era of "military communism", the general strategic path remained unchanged.

## REFERENCES

1. *Ўзбекистоннинг янги тарихи. Иккинчи китоб. Ўзбекистон совет мустамлакачилиги даврида. Тузувчилар: М.Жўраев, Р.Нуруллин, С.Камалов ва бошқалар. – Тошкент: Шарқ, 2000. – 688 б.*
2. *Ўзбекистон тарихи (1917-1991 йиллар). Биринчи китоб. 1917-1939 йиллар /Масъул муҳаррирлар Р.Абдуллаев, М.Раҳимов, Қ.Ражабов. – Тошкент: O'zbekiston, 2019. – 560 б.*
3. *Голованов А.А. Крестьянство Узбекистана: эволюция социального положения. 1917-1937 гг. – Ташкент: Фан, 1992. – 162 с.*
4. *Ўзбекистон Республикаси Марказий давлат архиви (ЎзР МДА), Р-90-фонд, 1-рўйхат, 1271-иш.*
5. *Ғойибназаров Ш. Ижтимоий ривожланиш сабоқлари. 20-йиллар таҳлили. – Тошкент: Ўзбекистон, 1994. – 192 б.*
6. *Аминова Р.Х. Аграрные преобразования в Узбекистане в годы перехода Советского государства к НЭПу. – Ташкент: Наука, 1965. – 345 с.*
7. *ЎзР МДА, Р-236-фонд, 1-рўйхат, 678-иш.*
8. *ЎзР МДА, Р-197-фонд, 3-рўйхат, 905-иш.*
9. *ЎзР МДА, Р-197-фонд, 3-рўйхат, 614-иш.*
10. *Два года работы правительства Узбекской Советской Социалистической Республики 1926 – 1927 – 1928. – Самарканд: 1928.*
11. *Джамалов О.Б. Социально-экономические предпосылки сплошной коллективизации сельского хозяйства в Узбекистане. – Ташкент: Госиздат УЗССР, 1950. – 256 с.*
12. *ЎзР МДА, Р-90-фонд, 1-рўйхат, 23-иш.*
13. *Кунакова Л.З. Земельно-водная реформа в Узбекистане (1925-1929 гг.) – Фрунзе: Мектеп, 1967. – 300 с.*
14. *Зелькина Е. Очерки по аграрному вопросу в Средней Азии. – Москва: 1930.*
15. *ЎзР МДА, Р-90-фонд, 1-рўйхат, 324-иш.*
16. *Материалы статистико-экономического обследования сельского хозяйства*



*Хорезмского округа УзССР. – Ташкент:  
1930.*

17. Бюллетень *Центрального  
статистического управления  
Узбекистана. 1925. №2.*
18. *Современный кишлак Средней Азии. Вып.  
V. – Ташкент: 1927.*
19. *Современный кишлак Средней Азии. Вып.  
III. – Ташкент: 1926.*



# THE PRAISE OF NATURE AND THE UNIVERSE IN NOVALIS ROMANCE

**Urakova Oysuluv Jamoliddinovna**

*Associate professor, Head of department Social-humanitarian science, Andijan state medical institute*

## ANNOTATION

*In this article, the philosopher from the major manifestations of German Romanticism aesthetics, the writer Novalis expresses the praise of nature and the universe in his Romanticism.*

**KEYWORDS:** *romanticism, nature, man, art, aesthetics, realism, creativity, beauty.*

***The poet and the saint were one from time immemorial, but the true poet is still a saint and the true saint is still a poet.***

***Novalis.***

Romanticism as an artistic method of aesthetic knowledge of life is formed throughout the entire development of human culture. Romanticism as a style is manifested in folk epics about heroism in the perception of the world, in fairy tales and unusual stories, the establishment of the possibility in relation to reality, the uniqueness of the situation and the human personality, the immaturity of Man and nature, the philosophy of the human soul and the idealization of the subjects described. European Romanticism influenced the formation of the aesthetics of Romanticism in the late XVIII and early XIX centuries, as a high example of romantic contemplation. This Romanticism manifests itself in traditional and legalized artistic styles. In this sense, the teachings of great scientists about man and nature are relevant from the point of view of the aggressive and selfish worldview of mankind. The gift of nature and its preservation are the largest and most important prophylactics. The idea of making friends with nature and taking care of a person at the level of his body also helps to look for an answer to unconditionally modern problems.

Contrary to the principle of "imitation of nature" in the aesthetics of Classicism, Romantics perceived the creative activity of the artist as their masterful beliefs. The artist, according to the

aesthetics of Romanticism, has the right to change the real world: he creates his own beautiful and real world.

Germany is considered a classic country of Romanticism, the basis of romantic aesthetics and world perception, developed by German writers and theorists, gave its first results in the work of representatives of the first generation of German Romanticism. Among the major manifestations of aesthetics in European Romanticism, the work of German philosophers Friedrich Schlegel and Novalis acquires importance. They defined the basic principles of romantic aesthetics. Nature is a wonderful combination of connoisseurs; poetry is a part of nature, its highest creativity; the poet and the clergyman are one, the poetic feeling has many similarities in the mystical sense.

Novalis has attributed the possibilities of romantic aesthetics to the degree of opportunity. In his opinion: "a true poet is a connoisseur of all things: he is a universe that has changed his understanding of reality a little (little broken)." Novalis therefore described poets as the greatest saints, and poetry as a set of divine words. "...Either nature itself must be responsible (bear) ideas, or the soul must be responsible for nature...", "... the landscape must feel like a body. The landscape is the ideal body for the soul."

Especially Novalis's lyrical series "Hymns of the Night" and the novel "Henry von Ofterdingen", "Fragments" are one of the masterpieces of creativity that reflect Romanticism. Novalis saw the peculiarity of romantic poetry in



the humanization of nature: thanks to the special construction of the poet's soul, the landscape acquires meaning and significance. Whoever is unable to hear and see the sound and hot of the Earth, the cry of nature, and the glory of the soul of the universe, he cannot cling to existence with his soul and body. In the cult of this accession, Novalis saw the subjectivity of poets, because of the unique "I" in their creativity, the work of the poet is "absolutely inexhaustible, like a person or a good idea". Because when a person is in harmony with nature, he finds joy and pleasure, and peace. Romance is a distance from modernity, whether it is the past, the future. Novalis assesses another feature of the poetry of romanticism: "the sound of philosophy coming from far away is like poetry, because any sound is music from far away. Around it or at the two poles is located a positive or negative poem. So it turns out that the whole thing is poetry in the distant. These are mountains in the distance, distant people and events, etc. From this very thing, a characteristic feature of poetry appears. Poetry appears at night and in the evening.

The melodic nature of romanticism is "ideal to aspiration", people like it, but lack it, otherwise the result will not turn into ideal, because abstract the idea of beauty will turn into a real thing or a real mistress with errors and shortcomings.

According to the aesthetic categories, the creators of ancient Greek philosophers (for example, Aristotle) and supporters of classicism, nature, society, imitating people, builds works that "improve, correct" and "generalize" them. In the same way, the ideal sublime is created by the creator, created by nature, society and people, what they think, gives the events a different – ideal tone, imitation of an aesthetic category created is mentioned in a new sense, a new look at. Human imagination is like a mirror, reflecting everything that is there, it connects its attitude to its aesthetic content. Creative people with high abilities perform this process at a higher resolution, so that the works have a high impact force and meaning. If talent is weak, the aesthetic ideal will also have lost its flight strength. Accordingly, the aesthetic ideal loses the existence, the limit of reality and its widen content, without coincidence. A trained person is formed by an aesthetic and a harmony of emotions in the writer's hands and eyes, not limited to the event and characteristic, bad behavior and prejudice of a single object and feature. If the writer wants to describe a phenomenon, a sheet, a view, a fairy, a fire, either a paradise, a hero or a traitor, a gale or a flood, a retreat with a single seen and heard plot, his own fantasy, tastes and potential, their unity comes into being an excellent aesthetic ideal.

Some writers try to imitate and resemble what they have, others imitate things, events, events, filling them with the power of thought, strongly the creators of the third group achieve an aesthetic image reminiscent of a rare, lush meadow in nature and society from separate branches. In the process, the writer should not strive to separately paint the aesthetic ideal, decorate its meaning and significance. Depending on the moral factors of the writer, it is possible to approach the living appearance, the situation of the aesthetic ideal, but it is not combined with it. In the aesthetic ideal, the images live in a mythical world, united by a certain imaginary desire and purpose. Sometimes in the context of an aesthetic ideal, the writer's goal can come in the uniformity, contradiction and imaginary direction of reality. Accordingly, in the aesthetic ideal, the thing, the person, the reality shown in their individual image. In this case, there are cases when the idea becomes an aesthetic idea, when the aesthetic ideal is filled with an idea. Even negative heroes will not lose their freedom and freedom, even though they lose their purpose, plan, and will be ready to give the soul in the ideal lump of intention, even at the point of death. Consequently, in the field of literature, various manifestations, actions, deeds, words, activities of the aesthetic ideal are felt. This opens the heroic, legendary and vital aspects of the aesthetic ideal. In artistic creativity, both the idea and the goal are in motion, without which it is difficult to form an aesthetic ideal and expressive image shape.

Novalis's description of romanticism expresses the psychological aspect of a complex problem. A feature characteristic of romanticism, the emergence of a romantic mood by observing the events of the past, expressed the rebellion of the creator's soul, the subjective approach to events. His creation is the gift of man's nature, the beauty of all being is determined by regular kindness towards him.

## REFERENCES

1. Ўроқова О. Ж. Чўлпон ижодининг бадий- эстетик моҳияти. « Илм зиё заковат»- Тошкент. 2019 .
2. Urakova O.J.The philosophical and aesthetic meaning of Abulhamid Chulpans idea of if literature is alive, so nation will live. *AjMR. Asin journal of Multidimensional Research/ ISSN 22278- 4853 Vol 8, 4 pril 2019 Impact Factor 6.053.Indiya. -179-184.*
3. Urakova O.J .*Expressiyon of Romanticizm in Art Literature. Экономика и социум.№3 (58) 2019.70-72*



4. *Urakova O.J Philosophical and artistic and aesthetic essence of Chulpans educational ideas.*
5. *Сборник «Литературная теория немецкого романтизма», Л, 1934, с.124.*
6. *Чулпон. Асарлар. IV жилд. – Тошкент: Akadempnashr, 2016. – Б. 186.*
7. *Дидро Д.. Об искусстве. Т. 1. – Москва: Искусство, 1936. – Б. 133.*





# CRIME ANALYSIS AND PREDICTION USING K-MEANS CLUSTERING TECHNIQUE

<sup>1</sup>Wasim A. Ali

*Research Scholar, Department of Computer Engineering, VTU-RC, Mysore, Karnataka, India.*

<sup>2</sup>Husam Alalloush

*PG. Department of Computer Science, St.Pholumena's College, Mysore, Karnataka. India.*

<sup>3</sup>Manasa K.N.

*Research scholar, PET Research Center( affiliated to University of Mysore), PES college of engineering, Mandya, Karnataka,India*

## ABSTRACT

*Analysis of crime is a collection of strategies that allow the police forces to become more effective through better knowledge. Our proposed framework aims to forecast the probability of a crime occurring in a city by analyzing the crime dataset and visualizing the findings for better comprehension on a google map. Here we can predict most places where the offense will happen. This research is achieved by using the clustering algorithm of K-means that group related objects into clusters. Officers will use this method to forecast criminal cases and take appropriate measures to apprehend offenders.*

**KEYWORDS** —Crime, Data mining, Clustering, K-Means, Google Map, Web application.

## INTRODUCTION

Today the crime rate is rising day by day and all the government's efforts around the world are directed at raising the crime rate. Using data mining, which is a great field of application with high data set volume, it has proven that it helps with its techniques to take advantage with historical data. This would help the police departments by analyzing the data and gaining from it the information. Data mining is composed of various techniques such as clustering, grouping, prediction, etc.

Clustering used to cluster objects (groups) with identical dataset attributes for further study and one of the clustering algorithms is k-means algorithm. Most of the crimes are unsolved and contain empty values so that we are limited in choosing clustering over classification. Clustering is regarded as the easiest and fastest clustering algorithm compared to other algorithms and is the best choice for clustering large data volume due to its lower computational speed. In this project we will create a web application with five features that can be useful for the police and this project will use

the crime dataset that belongs to Chicago city in the USA and we will implement the k-means algorithm in NetBeans software, Clustering the crime dataset and giving the results that will show us the crime-prone areas with the crime rate that occurred there, and determining the percentage of a particular crime that occurs in a particular area, as well as visualizing the results of each crime on the Google map, including the type, number and time required for police to take advanced crime reduction strategies.

## LITERATURE REVIEW

Jyoti Agarwal et al [1] proposed a system which includes steps for crime analysis starting with extraction of crime patterns and prediction the crime using k-means algorithm and that lead to detection of the crime at the end with the use of Rapid miner tool.

Manish Gupta et. al. [2] study the existing system in use by Indian police and highlighted the basic features of the system, then he introduced a criminal analysis tool which is based on data mining techniques that helps police department to carry



out the activities efficiently.

**Maloti and Santhosh Baboo [3]** proposed a crime analysis tool for Indian scenario and proved that it is effective for identifying crime patterns and prediction. To develop the tool, he develops a data cleaning algorithm and he enhanced clustering algorithm (Kmeans, DBScan).

**Kadhim Swadi Al-Janabi [4]** proposed a framework for crime and criminal data analysis. For data classification, he used decision tree algorithms and simple K-means for data clustering. The result is used for prediction of trends and behavior between crimes and criminals.

**Chris Delaney [5]** he pointed out about the importance of identifying and make tactical analysis of crime trends and patterns by criminal investigators all over the world.

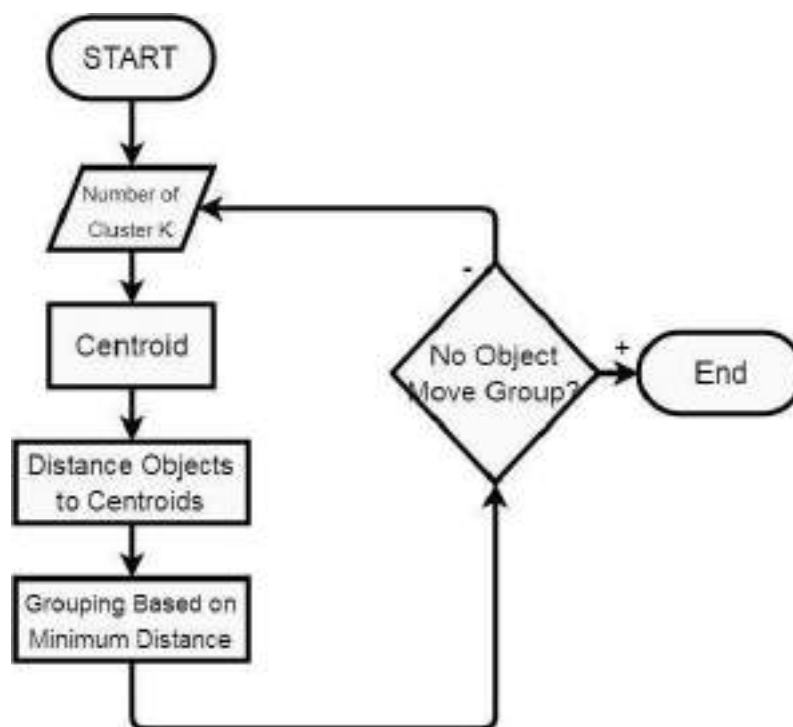
**Priyanka Gera and Rajan Vohra [6]** did a study at the use of clustering technique in data mining to analyze the crime patterns which helped to recognize which type of crime is more occurring and showed the distribution of each crime type in every area category.

## METHODOLOGY

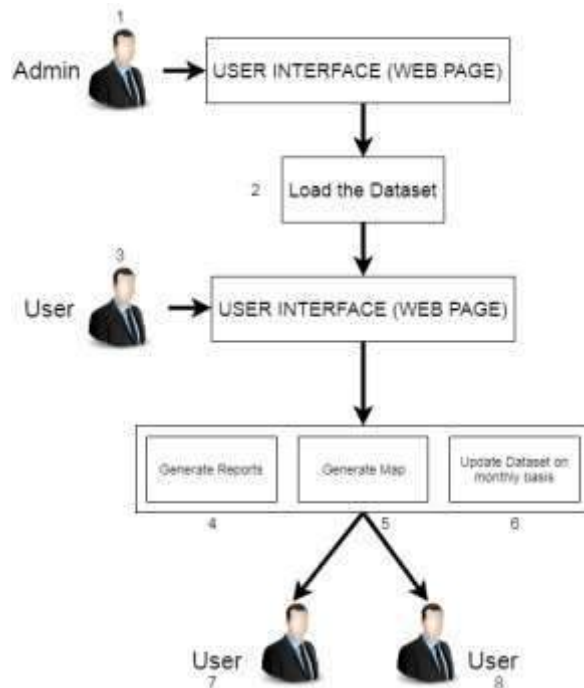
Data mining techniques can be applied in crime analysis and it help to take advantage of historical data and extract knowledge from it therefor help to take better decisions. A data mining approach such as clustering is used to cluster the data into groups where similar objects are placed together and in this system, clustering helps to group the same crime types together which means crime like “murder” are grouped together and same for “rape” cases and so on. In addition to that, the system determines the low, medium and high areas of crime based on the dataset K-means process consist of the following steps:

1. Choose k number of clusters as initial step.
2. Choose a set of K instances as centers of the clusters.
3. Each instance assigned by the algorithm to the cluster which is closest.
4. The cluster centroids are recalculated either after whole cycle of re-assignment or each instance assignment.
5. The process is iterated.

The algorithm requires specifying k number of clusters in advance. It is unable to handle noisy data and outliers and not suitable to discover clusters with non-convex shapes.



K-means is chosen to be used here because the ease of implementing it using java, plus its simplicity and speed which is very appealing in practice and it is



**Fig. 2. System Architecture**

The dataset imported from Chicago police department included 6.54M rows of committed crimes from 2011 until present and 22 columns such as (id, date, type, location...).

We are going to take this data and imported into NetBeans software and implement the k-means algorithm in java and here we aimed to implement the algorithm in the best way with an optimized code to ensure the efficacy and speed as well as the accuracy in the work. The next part is to choose the number of clusters and it is somehow subjective in general. As we saw, that we are dealing with a huge dataset, we decided to choose 10 clusters for better prediction. Then we can visualize the clusters that are created by k-means on the google map and determine the crime prone areas and each cluster is going to be denoted with a number indicates the crimes included in it. Then it will visualize the places where a specific crime occurs (such as there more theft incidents occurs at tourist destinations and that is the main work which is going to help the police to focus on some areas and take more precautions to prevent any future crimes and hence reduce the crime rate. We can also visualize all the crime locations of the city on the google map for good understanding of the situation. Additional feature is implemented to show the percentage of a specific crime that occur in specific part of the city and an example of that is "rape" incidents are twice in villages than cities. In

suitable for high volume crime dataset and can help to extract useful information.

In addition to that, implementing a performance features are necessary to help to monitor the rate of the crime to see if it is increasing or decreasing.

Finally, reports must be generated and can be download that contains the crime rate graphs and map images.

## MODULE DESCRIPTION

Proposed system consists of two modules, Admin Module and User Module.

Admin module where his work is to train the dataset and uploaded to make it available to the authorized users. The crime dataset should not contain any empty values and some dataset contain a lot of attributes so here we filter our dataset according to some requirements to ensure the accuracy in the clustering process.

The user module is about the user's work of determining the cluster number which is depends on the method used for measuring similarities and the parameters used for partitioning. Then applying the k-means algorithm on the dataset and starting his job for analyzing the crime patterns and monitoring the crime rate. Then generating the required reports that is going to be demanded by the employees in the police department. So here, many users can share the same work on analyzing the clustering results and trying with different number of clusters to ensure the accuracy and finally they can identify common crime patterns with the help of the system.

## CONCLUSION AND FUTURE WORK

This system is primarily used to cluster the dataset and apply the k-means algorithm on the crime dataset for the purpose of crime analysis, and to visualize the clustering results and crime incidents on the map and to prepare crime rate reports. This process is designed to help predict future crime based on the historical dataset. More functionality can be applied to this project in the future as a potential research that will be more useful and provide more knowledge about the crimes and offenders. Various methods may be used in the field of crime analysis by use a particular algorithm to better predict outcomes and to compare the performance and efficiency of the various Machine learning algorithms.

## REFERENCES

1. Jyoti Agarwal, Renuka Nagpal, Rajni Sehgal, "Crime Analysis using K-Means Clustering", *International Journal of Computer Applications* (0975-8887), Vol. 83, No. 04, 2013
2. Manish Gupta, B. Chandra and M. P. Gupta, "Crime Data Mining for Indian Police Information System", *Computer Society of India*, Vol. 40, No.



- 
- 1, pp. 388-397, 2008
  3. A. Malathi, Dr. S. Santhosh Baboo, *Algorithmic Crime Prediction Model Based on the Analysis of Crime Clusters*, *Global Journal of Computer Science and Technology* Volume 11 Issue 11 Version 1.0 July 2011.
  4. KadhimB.Swadi al-Janabi . A Proposed Framework for Analyzing Crime DataSet using Decision Tree and Simple K-means Mining Algorithms, *Journal of Kufa for Mathematics and Computer*, Vol.1, No.3, may2011Y.
  5. Chris Delaney, *Crime Pattern Definitions for Tactical Analysis*, *International Association of Crime Analysts (IACA)*, August 2011.
  6. Priyanka Gera and Rajan Vohra, *City Crime Profiling Using Cluster Analysis*, *International Journal of Computer Science and Information Technologies IJCSIT*, Vol. 5 (4), 2014.
  7. Chicago Police Department (Crime dataset in Chicago city in USA). <https://data.cityofchicago.org/Public-Safety/Crimes-2001-to-present/ijzp>



## A MODERN APPROACH TO SHAPING THE ENTREPRENEURIAL CULTURE OF YOUNG PEOPLE

**Jurayev Luqmon Narzilloyevich**  
*Samarkand State University, Docent, Uzbekistan*

### ANNOTATION

*This article analyzes the main categories of entrepreneurial activity and the concept of entrepreneurship, today textbooks and manuals are rarely discussed, the main focus is on its specific types. Through the article, you will see a philosophical analysis of entrepreneurship in social philosophy.*

**KEYWORDS:** *Business, economic activity, economic culture, pragmatism, positive, systematic approach, economic processes, human energy.*

### DISCUSSION

Today, a lot of practical work is being done in our country to further enhance the culture of entrepreneurship. It is known that Sh.Mirziyoyev paid great attention to the culture of entrepreneurship for the economic development of the country in the "Strategy of Action" for 2017-2021 and its five priority areas.<sup>1</sup> After the transition of Uzbekistan to a market economy, the economic and legal basis for entrepreneurship was created. Especially noteworthy is the work done by young people in our country to improve entrepreneurship. Life itself proves that the acquisition of entrepreneurial culture is a topical issue due to the limited natural resources but the growing population. 67% of the population of the country are young people. In particular, there is a need for rapid population growth and meeting their material needs. Therefore, the formation of a culture of entrepreneurship is a topical issue today. An entrepreneur is a person who engages in economic activities for profit.<sup>2</sup>

Entrepreneurial activity is an entrepreneurial activity carried out by business entities in accordance with the legislation, aimed at obtaining income (profit) at risk and under their own property liability.

Entrepreneurship and small business, in our opinion, will be more difficult to develop if the Republic does not rely on its own production,

including its resources - raw materials, material, intellectual, etc. But there are also countries that are well developed and prosperous (for example, Japan, Taiwan, etc.) without large raw material resources.

The main goal of the entrepreneur is to determine the need for the product in order to have its own consumers. An entrepreneur should take into account the following key factors in shaping his customers:

- The novelty of the product and its compliance with the interests of the buyer;
- Quality of goods or services;
- Price of goods or services;
- The degree of universality of the product;
- Appearance of the goods, its compliance with the requirements of the buyer;
- Possibility to use after-sales service;
- Compliance of the goods with the accepted general or state standards;
- Attractiveness of advertising of goods and services, attracting the attention of buyers, etc.

In the system of market relations, small business is manifested as a form of entrepreneurship characterized by the following distinctive features: the volume of production, the number of employees and to which industry it belongs.

Small business includes firms that have their own property and economic independence and are not considered high in their field of activity.<sup>3</sup>

<sup>1</sup> Sh.M. Mirziyoyev "Strategy of action" and its five priorities.

<sup>2</sup> Economic Theory.-M.: Humanit.-ed. Vladivos. 1999, p. 608.

<sup>3</sup> Baltabaeva Nigora Abdusattorovna. Entrepreneurial environment and directions of its development in the





Entrepreneurship and business have the same meaning, i.e. they are both profit-oriented economic activities.<sup>4</sup> The difference between entrepreneurship and production is that it is manifested in the organization of production, services, exchange, trade, consumption in all sectors of the economy. The subject of entrepreneurship is an individual, group, community, state, enterprise (if they operate on a business basis). The object of entrepreneurship can be different areas of economic activity, but its most common type is manufacturing, services and trade. No matter what the field of entrepreneurship, its main goal is to make a high level of profit, but it should not be understood as selfishness. Because the entrepreneur, in addition to pursuing his own interests, meets the needs of the people, increases national wealth, provides people with jobs, enriches the budget through taxes, invests in such areas as culture, education, health, introduces new technologies, ie goods and creates branded services and thus contributes to the development of economic culture.

A person engaged in entrepreneurial activity, in addition to a certain investment, must have deep economic knowledge, good experience in his field, initiative and will.

Ownership is not necessary to be an entrepreneur, you can also rent a means of production and borrow money.

The goods created in any case that can be engaged are his property.

The peculiarities of entrepreneurial activity are: the product of a market economy and free activity, associated with risk, new types and industries, new types of goods and services, the introduction of new techniques and technologies. Although entrepreneurship is a free economic activity, it is determined by existing legal norms (public health, life-threatening activities, drug trafficking, production and sale of weapons are prohibited by law. Entrepreneurship is also prohibited in matters related to taxes, money and credit not free), on the other hand, business activity is regulated by market laws. In business, the responsibility rests with the entrepreneur, that is, if the income exceeds the amount of expenses, he becomes rich, on the contrary, if the costs do not justify themselves, if the goods do not pass on the market, the entrepreneur is responsible with his money, and neither the state nor others.

That is why economic culture develops rational options in the regulation of economic life. In

particular, the following options are widely used in the modern economy.

In modern society, the entrepreneur is required to know the laws of rational economics in order to make society prosperous. These economic laws are:

1. On the basis of in-depth knowledge of economic laws, directing them to specific goals, control, planning;

2. Given that economic processes are manifested in the form of trends, to understand them in a timely manner, to direct them to specific goals, to develop accurate forecasts;

3. To penetrate from the surface phenomena of economic processes to their essence and on this basis to adopt and implement specific projects and programs;

4. To know the spontaneous, accidental, destructive, harmful moments in economic processes and to reduce and eliminate their impact;

5. Conscious regulation of economic life, ensuring the unity and integrity of the structure and functions of the economic system.

Given these circumstances, it is recommended that the entrepreneur develop measures such as “forecasting, modeling, planning, financing”. The regulation of the growing complexity of economic processes, the expansion of the management system, the increase in the number of people and resources involved in it, raises the problem of shaping the culture of management in recent times, and experts are clear about this. For example, E.G. “Organizational culture combines values and norms of management style,” Moll writes. In his view, organizational culture has two functions: adaptation to the external environment and ensuring internal integration. Some researchers further specify the issue, thinking about the principles of organizational culture, emphasizing that the organizational structure should be clear, the center of decision-making, the object and subject of the organization.

Entrepreneurial culture is also inextricably linked with production activities.

The fact that it has not yet been done makes the issue even more urgent.

The internal structure of economic activity is a complex phenomenon that varies depending on the exchange of processes. Nevertheless, it is possible to identify the relatively stable elements and flames in one system. The internal, cumulative structure of economic activity can be expressed as follows:

1. The subject of economic activity.
2. Motive of economic activity (material, spiritual needs).
3. Object, sphere of economic activity.
4. Means of economic activity (technical, media).

---

conditions of development of market economy master's dissertation. Fergana 2009 9-10 бет.

<sup>4</sup> Economic Theory.-M.: Humanit-ed. Vladivostok. 1999, p. 608.



5. Technology of economic activity (production, exchange, distribution, methods of consumption).

6. Conditions of economic activity (natural, technical, sanitary and hygienic conditions).

7. Purpose of economic activity.

8. Resources of economic activity (material and labor resources);

9. Results of economic activity.

10. Management activities.

These elements are constant constants of economic activity and must be present in all situations. If none of them is lacking, economic activity will not take place or become difficult. The degree of perfection of these elements determines the quality of economic culture. Such an analysis of the structure of economic activity has important methodological significance. Because based on the above elements, it is possible to classify economic activity in a certain way. For example, the subject of economic activity, the human factor can be divided into different types and levels depending on the professional and technical level, qualifications, the level of general culture. Also, depending on the motive of economic activity, it can be divided into types: needs → activity → product → consumption → needs (repetition of needs or emergence of new needs) and the process continues. From the point of view of cultural studies, the degree of harmonization of motives of economic activity is considered as the main criterion.

In fact, activity is purposeful and means engaging in production, non-production, and innovation in general in any area of society. Given that the subject of economic activity is studied in the field of economic theory, it requires the creation of a cumulative model of a functional, differential internal system of economic activity.

Human activity is important as a quality that is important in the formation of a person and the ability to change the environment according to their own requirements, views, goals. According to the scientist ZR Kadyrova, "The concept of human activity is inextricably linked with the concept of development. The essence of this principle is that human activity is constantly focused on self-expression."<sup>5</sup>

In this study by the scientist, K.A. Abulkhanova-Slavskaya gives the following definition of human activity: "Activity is a method of evaluating the modeling, structure and implementation of activity, communication and

behavior by a person, in which the person is more or less independent, more or less successful in interpersonal space. will have the qualities of a system".

In short, the time demands that the modern entrepreneur needs a rational understanding of economic processes and a thorough knowledge of economic laws. Entrepreneurial culture requires a creative and pragmatic approach to the development of society.

## LITERATURE

1. Sh.M. Mirziyoyev "Strategy of action" and its five priorities.
2. *Economic Theory.-M.: Humanit-ed. Vladivos. 1999, p. 608.*
3. Baltabaeva Nigora Abdusattorovna. *Entrepreneurial environment and directions of its development in the conditions of development of market economy master's dissertation. Fergana 2009 9-10.bet.*
4. *Economic Theory.-M.: Humanit-ed. Vladivos. 1999, p. 608.*
5. Qodirova Z.R. and others. *Socio-philosophical issues of increasing the social activity and tolerance of young people. T. : Institute of Philosophy and Law Publishing, 2006, pp. 32-33.*

<sup>5</sup> Qodirova Z.R. and others. Socio-philosophical issues of increasing the social activity and tolerance of young people. T. : Institute of Philosophy and Law Publishing, 2006, pp. 32-33.



# PROBLEMS OF ATTRACTING FOREIGN INVESTMENT INTO THE NATIONAL ECONOMY

**Goolbahor Abdusattarovna Karimova**

*PhD, Associate Professor of “Accounting in Agroindustry” Department,  
Andijan branch of Tashkent State Agrarian University*

## ABSTRACT

*This article provides the theoretical content of foreign investments, their classification in world practice. The types of attracting foreign investment in the economy of the Republic of Uzbekistan are discussed. The problems of attracting foreign investment to the Republic are listed, as well as conclusions and recommendations.*

**KEYWORDS-** *Foreign investment, national economy, direct investment, free economic zones, foreign capital, investors.*

## INTRODUCTION

In connection with the continuing instability of the economic situation of the Republic of Uzbekistan, many leading economists associate the future of our country with the attraction of foreign investments on a large scale to the economy, which pursues the long-term goals of creating a civilized society in the country characterized by a high standard of living of the population. It is hard to believe that foreign investment alone will help boost the country's economy. But on the other hand, they can serve as an incentive, catalyst for the development and growth of domestic investment. The inflow of foreign investment is vital for achieving such goals as getting out of the current crisis, and the initial recovery of the economy. At the same time, Uzbek public interests do not coincide with the interests of foreign investors, therefore, it is important to attract capital in such a way as not to deprive their owners of their own motivations, while simultaneously directing the actions of the latter for the benefit of public goals.

This task is solvable, but for this, first of all, it is necessary to study the specific state in the field of attracting foreign investment in the current Uzbek conditions, to consider the economic and legislative framework that ensure the investment climate in the country. At the same time, much attention should be paid to the last of the indicated, since today it is the uncertainty in this area that limits the investment process, that is, there is a kind of paradox: the

strongest tool for attracting foreign capital is simultaneously the main reason that keeps investors from making large investments.

## THE ESSENCE OF THE MATTER

Given the serious technological backwardness of our economy in most positions, Uzbekistan needs foreign capital, which could bring new (for Uzbekistan) technologies and modern management methods, as well as contribute to the development of domestic investments. The experience of many developing countries shows that an investment boom in an economy begins with the arrival of foreign capital. The creation of their own advanced technologies in a number of countries began with the assimilation of technologies brought in by foreign capital.

The experience of many Third World countries, especially Latin American ones, shows that unfavorable conditions for the operation of foreign companies within the country lead to the need for external government loans and an increase in the country's external debt. Moreover, since government loans are usually used ineffectively, large external debts begin to slow down economic development. In addition, government loans are a lever of political pressure and a cause of economic concessions.

Investing (exporting capital) is a multilateral process. By definition, investments are long-term capital investments in various sectors of the economy with the aim of making a profit. However, it should



be borne in mind that the implementation of investments, including foreign ones, should be a mutually beneficial process, that is, bring profit to both the object and the subject (investor).

In world practice, there are three main forms of investment:

1. Direct, or real, investments (investment of capital in industry, trade, services - directly into enterprises).
2. Portfolio, or financial, investments (investments in foreign stocks, bonds and other securities).
3. Medium and long-term international loans and loans of loan capital to industrial and commercial corporations, banks and other financial institutions.

Direct investment can provide investing corporations with either full ownership of the invested company, or they can establish effective control over it. Sometimes it is necessary to have no more than 10% of the share capital for this.[1]

The leading investors are economically developed countries, primarily the United States, but over the past 20 years their share in the total amount of foreign direct investment has declined.

Significant changes in the direction of direct investment: before the Second World War, the bulk of capital investment fell on backward countries, and recently, investors are attracted by countries with an already developed economic system. This behavior is explained by shifts in the sectoral structure of investment, which is now mainly concentrated in the manufacturing industry, and inside it - in knowledge-intensive and high-tech industries.

Portfolio investments are the main source of funds for financing shares issued by enterprises, large corporations and private banks

In the post-war period, the volume of such investments is growing, which indicates an increase in the number of private investors. Intermediaries in foreign portfolio investments are mainly investment banks (intermediary organizations in the securities market that finance long-term investments).

The movement of this type of investment is influenced by the difference in the rate of interest rates paid on various securities. Thus, the high rate of interest rates in the United States attracted many foreign investors, especially Japanese.

The main ways to attract foreign direct investment in the economy of Uzbekistan are:

- attracting foreign capital in an entrepreneurial form by setting up joint ventures (including by selling large blocks of shares in joint-stock companies to foreign investors);
- registration on the territory of Uzbekistan of enterprises fully owned by foreign capital;

- attraction of foreign capital on the basis of concessions or production sharing agreements;
- creation of free economic zones (FEZ) aimed at actively attracting foreign investors to certain regions of the country.

In the investment sphere, a number of key problems are noted that impede the effective provision of socio-economic development, the main of which is the insufficient volume of attracted investments, including foreign direct and their irrational distribution, says the draft Strategy of the Investment Policy of the Republic of Uzbekistan until 2025, developed by the Ministry of Economy and industry.[2]

The following are the key problems and imbalances in the dynamics and structure of investment flows:

1. Lack of investment is a key development challenge in Uzbekistan. In 2018, gross fixed capital formation stood at \$ 13.3 billion, or 26.3% of GDP. The level of fixed capital formation per capita is only 20% of the world average and 25% of the CIS average. The republic remains in the penultimate place, ahead of the CIS countries only Kyrgyzstan.[4]

2. The volumes of attracted foreign direct investment are insufficient, and their sources are not diversified. In 2018, foreign investments of \$ 3.9 billion were mastered, which indicates the low activity of attracting foreign investment in the sectors of the economy, in particular, due to the insufficiently favorable investment climate in the country.

3. The high differentiation of regions in attracting investment resources remains. For example, almost 44% of attracted investments in the republic for 2013-2018. accounted for 3 territories (Tashkent city, Kashkadarya, Bukhara regions) and the share of 5 regions (Andijan, Jizzakh, Syrdarya, Surkhandarya and Khorezm regions) was 16.2%.[4]

4. The level of attracting investments for modernization, technical and technological re-equipment is insufficient to ensure an effective reproduction process. A retrospective analysis revealed that since 2007, in the reproduction structure of investments, 62% -63% of the total volume of investments is the construction of new enterprises, while the expansion, reconstruction, modernization, technical and technological renewal of production facilities is only 21% -22%.[4]

5. The structure of investment resources does not correspond to the existing structure in developed countries. The capital market (investments in corporate securities) currently provides only slightly more than 0.4% of the volume of investments, which is much less than in a number of CIS countries. The domestic stock market has not yet emerged as an important source of investment.





6. High level of government presence in the economy. State-owned enterprises continue to dominate the national economy, occupying a significant share in the fuel and energy, mining, engineering, transport, chemical and telecommunications industries.

7. Growth in inflation. As noted above, in recent years there has been an increase in the average monthly rise in prices, which in turn leads to both an increase in the cost of borrowed capital (bank loans) and an increase in capital requirements for the implementation of investment projects and activities, and the complexity of assessing the profitability of investments in the future. In conditions of weak financial situation of enterprises, with a high level of inflation, they have difficulties with the availability of working capital, which in turn does not allow them to allocate funds for investments.

8. Deterioration of the financial condition of the leading enterprises due to the incomplete process of changing the tax burden, curbing the growth of tariffs and maintaining a number of enterprises with a large amount of accumulated debt. The current situation does not allow to fully compensate for production costs and timely finance modernization, technical and technological re-equipment programs.

9. Insufficient level of infrastructure and communications development. In some areas, there is still a large number of unused production capacity, problems with electricity supply, and weak engineering and communication infrastructure in rural areas. In Uzbekistan, there are very few efficiently operating multimodal transport and logistics terminals, warehouse complexes of the international level, there are many scattered warehouse operators that do not fully meet international requirements. In the near future, with an increase in exports and, accordingly, cargo transportation, they will be in demand.[3]

10. A low level of activity of the processes of renewal and modernization of fixed assets, especially in manufacturing sectors. Thus, the rate of renewal of fixed assets was 17.4% in the economy and 15.9% in the industry, with the wear rate being 40.4% and 38.3%, respectively. As for the active part of fixed assets - machinery and equipment, the renewal rate was 16.8% in the economy and 16.6% in the industry, and the depreciation rate - 49.7% and 45.9%, respectively. The average service life of fixed assets is 15.9 years in the economy and 20.7 years in industry, and machinery and equipment - 22.2 years and 29.1 years, respectively.[4]

11. Lack of own engineering and research and development, own developments and technologies. Industries rely heavily on external partners, their technology (including design, product upgrades) and marketing strategy. The situation is

aggravated by the instability and disproportions in the distribution of investment in innovation.

12. Low level of manufacturability. In OECD countries, the shares of high- and medium-high-tech sectors in the structure of the manufacturing industry are on average 19% and 28%, respectively, and in reference countries (China, Korea, Malaysia, Singapore, Thailand, Finland, Indonesia) - 19.2% and 31.5%. In Uzbekistan, at the end of 2017, these indicators were 1.6% and 17.1%.

13. Low level of localization and strong dependence on imported components. Along with this, the analysis of merchandise imports for the last 2016-2017. showed that imports of products of high- and medium-high-tech sectors account for 46.4% of total imports, of which 34.9% are machinery and equipment. The share of medium-low and low-tech sectors is 28.7%, including 12.7% of imports of spare parts and materials for machinery and equipment.

14. A significant gap in the "value chain". So, for example, in the textile industry, most of the investment has recently been directed to the production of knitted fabrics due to lower risk and lower volumes of required capital investments, although the production of fabrics provides a greater increase in added value. From 2012 to 2016, the volume of production of cotton fabrics increased 1.9 times, while the production of knitted fabrics increased 2 times over the specified period.[4]

## CONCLUSION

From all of the above, we can conclude that foreign capital, having almost no significant impact on the development of the national economy as a whole, is now playing the role of a "growth catalyst" only in a few narrow production sectors focused primarily on foreign demand.

In order to achieve a significant quantitative increase in foreign direct investment in the country's economy, it is possible by developing a comprehensive state program to attract foreign investment. Taking into account the experience of many foreign countries, the measures necessary for Uzbekistan in this direction (in addition to the general improvement of the political and macroeconomic situation) should include:

- creation of a really operating system of benefits for foreign investors in certain industries and regions (in particular, the creation of real operating free economic zones);
- a clear delineation of ownership between economic entities, as well as between state and local authorities;
- creation of stable economic and foreign trade legislation;
- reducing the tax burden and simplifying the tax structure;





- introduction of private ownership of land;
- Creation of mechanisms for insurance of foreign investments.

Summing up all of the above, it can be noted that attracting foreign investment in the country's economy, which is one of the necessary conditions for the country's exit from the economic crisis, requires significant rule-making and organizational efforts from both central and regional authorities, and from individual enterprises and financial institutions. In general, these efforts should be aimed at:

- improving the overall investment climate in Uzbekistan, stabilizing the economic and legislative situation and creating effective economic legislation;
- organization of an efficient intra-republican capital market, providing a full-fledged connection between the securities market and the real sector;

Currently, in Uzbekistan, there is an increase in the inflow of foreign investment. Nevertheless, in absolute terms, foreign investment remains very small and clearly does not meet the needs of the country's economy.

## REFERENCES

1. Akhmedov D.K. *Business sentiment in the reform process. The dialogue between the state and business has determined the ways to improve the investment climate // Economic Review No. 5 (221), 2018, pp. 80-84.*
2. Karimova, G. A. (2019). *Financial instruments as a mechanism for attracting foreign investment. ISJ Theoretical & Applied Science, 10 (78), 60-64.* SoI: <http://s-o-i.org/1.1/TAS-10-78-10> Doi: <https://dx.doi.org/10.15863/TAS.2019.10.78.10>
3. Karimova, G. A. (2019) *Prospects of development of financial mechanisms of attraction of foreign investments in the Republic of Uzbekistan. International Journal of Research in Management & Business Studies (IJRMBS 2019), Vol. 6 Issue 4 Oct. - Dec. 2019, 18-21.* <http://ijrmbs.com/vol6issue4/goorbahor.pdf>
4. *Statistical collection of the State Statistics Committee of the Republic of Uzbekistan "Socio-economic situation in the Republic of Uzbekistan. January-December 2018 ", Tashkent, 2019. pp. 96-121.*



# **USAGE PATTERN OF LIBRARY RESOURCES BY THE FACULTY MEMBERS OF NAAC ACCREDITED DEGREE COLLEGES IN KADAPA DISTRICT: A STUDY**

**Mr.M.V.Krishna Reddy**

*Assistant Librarian, Loyala Degree College, Pulivendula, Y.S. R. Kadapa District*

**Dr.M.Anjaiah**

*Assistant Professor, Dept. of Library & Information Science, Dravidian University, Kuppam, Chittoor District, A.P.*

**Dr.M.Doraswamy**

*Professor & Head, Dept. of Library & Information Science, Dravidian University, Kuppam, Chittoor District, A.P.*

Article DOI: <https://doi.org/10.36713/epra4841>

## **1. INTRODUCTION**

Any library irrespective of its kind has to be user oriented. All the services provided by the library are intended for the benefit of the users. In order to improve the existing library services, planning for new services, rationalize the limited financial resources in an economic way, evaluate the performance of the library and enhance the user satisfaction, it is imperative to conduct user studies. These studies will help library authorities to know the utilization and satisfaction of users with existing library resources, services and facilities, the type of new services required and the amount of finance required for their implementation. Usage and satisfaction studies are also part of user studies as these are based on users. The performance of any library can be judged on the basis of extent of usage and satisfaction it is providing to its users. Hence, there is need to conduct user studies to assess the usage and satisfaction of users with the resource, services and facilities provided by the library. These studies are also essential to know the differences in satisfaction among the differences in usage and satisfaction among the different categories of users. Necessary measures can be taken in case of the users are dissatisfied with the library services and facilities by finding out the reasons for their dissatisfaction.

The present study makes an attempt in this direction by studying the usage pattern of library resources by the faculty members of NAAC accredited degree colleges in Kadapa District. Efforts have been made to know the differences in usage and satisfaction between the faculty members of NAAC degree college libraries and finally to make recommendations to improve the present library resources, services and facilities.

## **2. OBJECTIVE OF THE STUDY**

- The main objective of the study is to study the usage levels on various library print resources such as books, journals/magazines, newspapers, question papers, project reports, and back volumes of periodicals reference books, made by the faculty members.
- Recommend concrete suggestions and recommendations to authorities for improving the library collection basin on inputs collected from faculty members.

## **3. HYPOTHESIS OF THE STUDY**

- There would not be any significant differences in the usage level of various library resources between the male and



female faculty members, and arts and science faculty members.

#### 4. METHODOLOGY

In order to study the information used by faculty members of select NAAC accredited degree college libraries in Kadapa district of the state of Andhra

Pradesh in India. There are 94 different degree colleges (such as Government, Aided and Private) within the territorial jurisdiction of Kadapa district. Out of 94 degree colleges, 10 colleges have been accredited by NAAC. Hence, the researcher selected users from these ten colleges (list in Table 1) as the sample respondents in the first instance.

**Table 1: List of Sample Colleges**

S.No	Name of the College	Place
1	C S S R & S R AM Degree College	Kamalapuram
2	Government Arts College for Men	Kadapa
3	Government Degree College	Rajampet
4	Government Degree College	Koduru
5	Government Degree College	Porumamilla
6	Government Degree College	Jammalamadugu
7	Loyala Degree College	Pulivendula
8	S B V R Degree College	Badvel
9	S C N R Government Degree College	Proddatur
10	SKR & SKR Government College for Women	Kadapa

It is observed that there are four categories of users enrolled in the selected NAAC degree college libraries namely.

1. Undergraduate students
2. Post graduate students
3. Non-teaching staff; and
4. Faculty members

The present study is limited to survey of the users belonging to the faculty members only which is located in serial no.4 of the hierarchy.

At present, there are 335 faculty members are working in the selected ten NAAC accredited degree colleges in Kadapa district. Since the population is meager, the researcher has selected all the faculty members by following the census sampling method. The researcher distributed 335 questionnaires and received responses from 271 (81%) faculty members only which include language teaching faculty members who are connected with arts and science stream. The inclusion of language teaching faculty in the sample is done due to the size of the sample is flimsy. Out 271, 174 male faculty members and 97 female faculty members; 86 are arts faculty members and 185 science faculty members.

#### 5. DATA ANALYSIS

After collecting the data from the users of NAAC accredited degree colleges, the data is checked and analysed according to the objectives and hypothesis stated. First the data is recorded on the data sheets and then fed into the computer personally. The data has been tested with various statistical tools (Descriptive statistics and Chi-square test) by using the SPSS. If the observed frequency is less than five in any cell of row, that row is merged with its adjacent row while calculating chi-square value. However, some of the calculations are done with the help of a calculator. The data has been presented in the form of tables in the following paragraphs.

#### 6. UTILISATION OF LIBRARY RESOURCES AND SERVICES

To know faculty usage level of different library print resources, namely books, journals/magazines, newspapers, question papers, project reports, and back volumes of periodicals were examined in the following paragraphs.

##### 6.1 Books

The allocation of faculty members according to their level of usage of books in the library, in relation to gender and disciplines is displayed in Table 2.

**Table 2: Allocation of faculty members according to the level of usage of books**

Level of use	Gender		Discipline		Total
	Male	Female	Arts	Science	
Highly	58 (33.33)	31 (31.96)	27 (31.39)	62 (33.51)	89 (32.84)
Frequently	91 (52.30)	53 (54.64)	47 (54.65)	97 (52.43)	144 (53.14)
Occasionally	17 (9.77)	8 (8.25)	6 (6.98)	19 (10.27)	25 (9.22)
Rarely	(4.60)	5 (5.15)	6 (6.98)	7 (3.79)	13 (4.80)
<b>TOTAL</b>	<b>n=174 (100.00)</b>	<b>n=97 (100.00)</b>	<b>n=86 (100.00)</b>	<b>n=185 (100.00)</b>	<b>N=271 (100.00)</b>
$\chi^2$ (Male- Female) = 0.2968      DF: 3      TV: 7.815 Not Significant @ 0.05 level $\chi^2$ (Arts- Science) = 2.0726      DF: 3      TV: 7.815 Not Significant @ 0.05 level					

(Note: Numbers indicated in parentheses are percentages)

Table 2 shows that 53.14 percent of the faculty members are using the books frequently, 32.84 percent of them are using highly, 9.22 percent of them are using occasionally, and the remaining 4.80 percent are using rarely.

Based on  $\chi^2$  values (in Table 2) that there are no significant differences in the level of usage of books available in their libraries between the faculty

members of male and female, and arts and science faculty members.

### 6.2 Journals/Magazines

The allocation of faculty members according to their level of usage of journals/magazines in the library, in relation to gender and disciplines is displayed in Table 3.

**Table 3: Allocation of faculty members according to the level of usage of journals/magazines**

Level of use	Gender		Discipline		Total
	Male	Female	Arts	Science	
Highly	38 (21.84)	14 (14.43)	13 (15.12)	39 (21.08)	52 (19.19)
Frequently	68 (39.08)	41 (42.27)	36 (41.86)	73 (39.46)	109 (40.22)
Occasionally	40 (22.99)	17 (17.53)	16 (18.60)	41 (22.16)	57 (21.03)
Rarely	28 (16.09)	25 (25.77)	21 (24.42)	32 (17.30)	53 (19.56)
<b>TOTAL</b>	<b>n=174 (100.00)</b>	<b>n=97 (100.00)</b>	<b>n=86 (100.00)</b>	<b>n=185 (100.00)</b>	<b>N=271 (100.00)</b>
$\chi^2$ (Male- Female) = 5.806      DF: 3      TV: 7.815 Not Significant @ 0.05 level $\chi^2$ (Arts- Science) = 3.0483      DF: 3      TV: 7.815 Not Significant @ 0.05 level					

(Note: Numbers indicated in parentheses are percentages)

Table 3 shows that 40.22 percent of the faculty members are using the journals/magazines frequently, 21.03 percent of them are using occasionally, 19.56 percent of them are using rarely, and the remaining 19.19 percent are using highly.

Based on  $\chi^2$  values (in Table 3) that there are no significant differences in the level of usage of journals/magazines available in their libraries

between the faculty members of male and female, and arts and science faculty members.

### 6.3 Newspapers

The allocation of faculty members according to their level of usage of newspapers in the library, in relation to gender and disciplines is displayed in Table 4.

**Table 4: Allocation of faculty members according to the level of usage of newspapers**

Level of use	Gender		Discipline		Total
	Male	Female	Arts	Science	
Highly	53 (30.46)	28 (28.87)	27 (31.40)	54 (29.19)	81 (29.89)
Frequently	91 (52.30)	54 (55.67)	43 (50.00)	102 (55.13)	145 (53.51)
Occasionally	19 (10.92)	7 (7.22)	9 (10.46)	17 (9.19)	26 (9.59)
Rarely	11 (6.32)	8 (8.24)	7 (8.14)	12 (6.49)	19 (7.01)
<b>TOTAL</b>	<b>n=174 (100.00)</b>	<b>n=97 (100.00)</b>	<b>n=86 (100.00)</b>	<b>n=185 (100.00)</b>	<b>N=271 (100.00)</b>
$\chi^2$ (Male- Female) = 1.4048      DF: 3      TV: 7.815 Not Significant @ 0.05 level $\chi^2$ (Arts- Science) = 0.7134      DF: 3      TV: 7.815 Not Significant @ 0.05 level					

(Note: Numbers indicated in parentheses are percentages)

Table 4 shows that 53.51 percent of the faculty members are using the newspapers frequently, 29.89 percent of them are using highly, 9.59 percent of them are using occasionally, and the remaining 7.01 percent are using rarely.

Based on  $\chi^2$  values (in Table 4) that there are no significant differences in the level of usage of newspapers available in their libraries between the

faculty members of male and female, and arts and science faculty members.

#### 6.4 Question papers

The allocation of faculty members according to their level of usage of question papers in the library, in relation to gender and disciplines is displayed in Table 5.

**Table 5: Allocation of faculty members according to the level of usage of question papers**

Level of use	Gender		Discipline		Total
	Male	Female	Arts	Science	
Highly	47 (27.01)	21 (21.65)	17 (19.77)	51 (27.57)	68 (25.09)
Frequently	88 (50.58)	49 (50.52)	44 (51.16)	93 (50.27)	137 (50.56)
Occasionally	26 (14.94)	12 (12.37)	11 (12.79)	27 (14.59)	38 (14.02)
Rarely	13 (7.47)	15 (15.46)	14 (16.28)	14 (7.57)	28 (10.33)
<b>TOTAL</b>	<b>n=174 (100.00)</b>	<b>n=97 (100.00)</b>	<b>n=86 (100.00)</b>	<b>n=185 (100.00)</b>	<b>N=271 (100.00)</b>
$\chi^2$ (Male- Female) = 4.8581      DF: 3      TV: 7.815 Not Significant @ 0.05 level $\chi^2$ (Arts- Science) = 5.8812      DF: 3      TV: 7.815 Not Significant @ 0.05 level					

(Note: Numbers indicated in parentheses are percentages)

Table 5 shows that 50.56 percent of the faculty members are using the question papers frequently, 25.09 percent of them are using highly, 14.02 percent of them are using occasionally, and the remaining 10.33 percent are using rarely.

Based on  $\chi^2$  values (in Table 5) that there are no significant differences in the level of usage of question papers available in their libraries between

the faculty members of male and female, and arts and science faculty members.

#### 6.5 Project reports

The allocation of faculty members according to their level of usage of project reports in the library, in relation to gender and disciplines is displayed in Table 6.





Table 6 shows that 28.04 percent of the faculty members are using the project reports occasionally, 21.77 percent of them are using rarely, 21.03 percent of them are using frequently, 16.98

percent of them are using highly, and the remaining 12.18 percent are not using.

**Table 6: Allocation of faculty members according to the level of usage of project reports**

Level of use	Gender		Discipline		Total
	Male	Female	Arts	Science	
Highly	31 (17.82)	15 (15.46)	14 (16.28)	32 (17.30)	46 (16.98)
Frequently	36 (20.69)	21 (21.65)	19 (22.09)	38 (20.54)	57 (21.03)
Occasionally	53 (30.46)	23 (23.71)	22 (25.58)	54 (29.19)	76 (28.04)
Rarely	37 (21.26)	22 (22.68)	21 (24.42)	38 (20.54)	59 (21.77)
Not	17 (9.77)	16 (16.50)	10 (11.63)	23 (12.43)	33 (12.18)
<b>TOTAL</b>	<b>n=174 (100.00)</b>	<b>n=97 (100.00)</b>	<b>n=86 (100.00)</b>	<b>n=185 (100.00)</b>	<b>N=271 (100.00)</b>
$\chi^2$ (Male- Female) = 3.6119      DF: 4      TV: 9.488 Not Significant @ 0.05 level $\chi^2$ (Arts- Science) = 0.8124      DF: 4      TV: 9.488 Not Significant @ 0.05 level					

(Note: Numbers indicated in parentheses are percentages)

Based on  $\chi^2$  values (in Table 6) that there are no significant differences in the level of usage of project reports available in their libraries between the faculty members of male and female, and arts and science faculty members.

### 6.6 Back volumes of periodicals

The allocation of faculty members according to their level of use of back volumes of periodicals in the library, in relation to gender and disciplines is displayed in Table 7.

**Table 7: Allocation of faculty members according to the level of use of back volumes of periodicals**

Level of use	Gender		Discipline		Total
	Male	Female	Arts	Science	
Highly	29 (16.67)	14 (14.43)	11 (12.79)	32 (17.30)	43 (15.87)
Frequently	48 (27.59)	29 (29.90)	25 (29.07)	52 (28.11)	77 (28.41)
Occasionally	54 (31.03)	11 (11.34)	8 (9.30)	57 (30.81)	65 (29.99)
Rarely	31 (17.82)	18 (18.56)	16 (18.61)	33 (17.84)	49 (18.08)
Not	12 (6.90)	25 (25.77)	26 (30.23)	11 (5.94)	37 (13.65)
<b>TOTAL</b>	<b>n=174 (100.00)</b>	<b>n=97 (100.00)</b>	<b>n=86 (100.00)</b>	<b>n=185 (100.00)</b>	<b>N=271 (100.00)</b>
$\chi^2$ (Male- Female) = 26.6574      DF: 4      TV: 9.488 Significant @ 0.05 level $\chi^2$ (Arts- Science) = 37.4761      DF: 4      TV: 9.488 Significant @ 0.05 level					

(Note: Numbers indicated in parentheses are percentages)

Table 7 shows that 29.99 percent of the faculty members are using the back volumes of periodicals occasionally, 28.41 percent of them are

using frequently, 18.08 percent of them are using rarely, 15.87 percent of them are using highly, and the remaining 13.65 percent are not using.



Based on  $\chi^2$  values (in Table 7) that there are significant differences in the level of usage of back volumes of periodicals between the faculty members of male and female, and arts and science faculty members. That means more male faculty members are using the back volumes of periodicals when compared to female faculty members; and science faculty members are using heavily compared to arts faculty members in this regard.

## 7. FINDING AND SUGGESTIONS

1. A majority of the faculty members (53.14%) are using the books frequently, 32.84 percent of them are using highly, 9.22 percent of them are using occasionally, and 4.80 percent are using rarely.
2. Most of the faculty members (40.22%) are using the journals/magazines frequently, 21.03 percent of them are using occasionally, 19.56 percent of them are using rarely, and 19.19 percent are using highly.
3. A majority of the faculty members (53.51%) are using the newspapers frequently, 29.89 percent of them are using highly, 9.59 percent of them are using occasionally, and 7.01 percent are using rarely.
4. A greater part of the faculty members (50.56%) are using the question papers frequently, 25.09 percent of them are using highly, 14.02 percent of them are using occasionally, and 10.33 percent are using rarely.
5. 28.04 percent of the faculty members are using the project reports occasionally, 21.77 percent of them are using rarely, 21.03 percent of them are using frequently, 16.98 percent of them are using highly, and 12.18 percent are not using.
6. 29.99 percent of the faculty members are using the back volumes of periodicals occasionally, 28.41 percent of them are using frequently, 18.08 percent of them are using rarely, 15.87 percent of them are using highly, and 13.65 percent are not using.
7. There are no significant differences in the level of usage of books, journals/magazines, newspaper, and project reports available in their libraries between the faculty members of male and female, and arts and science faculty members.
8. Majority of the male faculty members are using the back volumes of periodicals when compared to female faculty members.
9. More number of science faculty members are using the back volumes of periodicals compared to arts faculty members.

10. The budget for the purchase of books should be enhanced in proportion to the rising cost of books as well as to meet the increasing demands of the reading community.
11. The existing financial resources for purchase of books are to be utilized in a scientific way based on the needs of the reading community.
12. Subscribe to the core periodicals/journals in various branches only on the basis of user survey results.

## REFERENCES

1. Doraswamy, M., & Appalaswami Naidu, V. (2020). Utilization of Print Resources in Degree College Libraries in Visakhapatnam District: An Analytical Study. *International Journal of Management*, 11(2), 209-220.
2. Krishna Reddy, M.V., Anjaiah, M., & Doraswamy, M. (2020). Information use by the faculty members of NAAC accredited degree colleges in Kadapa district: A study. *Aegauem Journal (UGC Care List-II)*, 8(7), 1004-1011.
3. Kusuma Kumari, K., & Doraswamy, M. (2019). Users Perception on Library Printed Resources: A Survey on NAAC Accredited Degree Colleges in Vijayawada City. *International Journal of Research and Analytical Review*, 6(2), 592-599.
4. Doraswamy, M. (2015). Customer satisfaction of library print resources in autonomous college libraries: A case study of MBA students. *SRELS Journal of Information Management*, 52(3), 213-217.
5. Doraswamy, M. (2012). Information use pattern towards library services and facilities by the faculty members of Siddhartha Educational Institutions Vijayawada, Andhra Pradesh: a study. *International Journal of Information Dissemination and Technology*, 2(3), 176-181.



# THE IMPACT OF ENVIRONMENTAL PERFORMANCE AND THE PER CAPITA GROSS DOMESTIC PRODUCT ON GREEN ECONOMY: AN EMPIRICAL INVESTIGATION

**Tharindu Udayanga Kamburawala**

*Department of Economics, University of Kelaniya, Sri Lanka*

## ABSTRACT

*An inclusive green economy is an alternative to today's dominant economic model. Over the past decade, the concept of green economy has emerged as a strategic priority for many governments. However, 62% of world countries have not yet attained a considerable green economic performance. Because of this inadequate green economic performance, most of countries are still unable to reach green economic targets and to implement effective and efficient policies that direct to environmental and economical sustainability. Theoretically, the balanced growth of economic, environmental and social sectors is required to attain a considerable green economic performance. This study attempts to examine the overall influence of environmental performance and the per capita gross domestic product on green economy. Research was based on the cross-sectional data for the year 2018, covering 128 countries. Data were extracted from the World Bank, Centre for Environmental Law and Policy and Dual Citizen LLC databases. The operational methodology adopted is a multiple regression model on the variables such as Green Economy Index, Environmental Performance Index and Per Capita Gross Domestic Product. Multicollinearity, Heteroscedasticity and the Normal Distribution of the residuals have been checked in diagnostics tests. The findings of the study reveal the significant positive relationship between the green economic performance and the independent variables. Although, there is a statistically significance influence from the independent variables, the overall impact is not in a considerable level. Thus, the Environmental Performance and the Per Capita Gross Domestic Product of the countries must be improved more. Further, research highlighted the necessity of delivering balanced attention to the development of economic, environmental and social sectors. Research suggests policy makers to promote the social market economic policies which target the sensible enhancement of those sectors.*

**KEY WORDS:** *Environmental Performance, Green Economy, Per Capita Gross Domestic Product*

## INTRODUCTION

The green economy is put forward as an effective solution to both economic crisis and ecological devastation. Green economy is a tool aiming at the development of society, prosperity without draining resources, a return on investment without neglecting the protection of the environment, long term economic growth, social inclusion and institutional actions towards human well-being (Baronio, 2018). International Chamber of Commerce describes the green economy as an economy in which economic growth and environmental responsibility work together in a

mutually reinforcing fashion while supporting progress on social development.

Accomplishing the global green economic targets varies on the green economic performance of the countries. An index measuring green economic performance is important to support policy makers and the private sector in making smart decisions about policies and investments to accelerate the transition to a greener economy (dualcitizeninc.com, 2019). The Global Green Economy Index (GGEI) is the world recognized tool that measures the green economic performance of 130 countries. This index has been developed by the Dual Citizen LLC, a private U.S-based consultancy. GGEI uses



quantitative and qualitative indicators to measure how well each country performs on four key dimensions: leadership and climate change, efficiency sectors, markets and investments and the environment. According to the results of the GGEI in 2018, Sweden has marked the best green economic performance by scoring 0.7608 marks. Bahrain has the lowest green economic performance among the world countries. GGEI 2018 highlights the lower green economic performance of the developing countries. Therefore, effective policies must be formulated to uplift the green economic performance of the countries.

When devising policies that drive countries to green economies, discovering the concepts of green economy in depth is much needed. Confusion of the concepts and the inefficient policies may cause inadequate green economic performance. Although theoretical background confirms the necessity of balanced development of economic, environmental and social sectors to attain a considerable green economic performance, the social sector development and making social inclusiveness have been mostly eliminated from the policy formulation of the least developed countries. This research has empirically verified the incapacity of accomplishing a substantial green economic performance without formulating balanced economic policies. Based on the findings, research implies policy makers to formulate social market economic policies that are vital for attaining a steady sector development.

## LITERATURE REVIEW

### *Theoretical Background*

Sustainable development has been the principal goal of the international community since the United Nations Conference on Environment and Development (UNCED) in 1992. Among numerous commitments, the conference called upon governments to develop national strategies for sustainable development, incorporating policy measures outlined in the Rio Declaration. Despite the effort of many governments to implement such strategies as well as international cooperation to support national governments, there are continuing concerns over global economic and environmental developments in many countries. These have been strengthened by recent prolonged global energy, food and financial crises, and emphasised by continued warnings from global scientists that society is in danger of misbehaving a number of planetary boundaries or ecological limits (Rockstrom, 2009).

Whilst considering these ecological limits, green economy has been proposed as a means for catalysing renewed national policy development and international cooperation and support for sustainable development. The concept has received significant international attention over the past few years and it

has resulted in a rapidly expanding literature including new publications on a green economy.

The term green economy was first coined in a pioneering 1989 report for the Government of the United Kingdom by a group of leading environmental economists, entitled *Blueprint for a Green Economy*. In 1991 and 1994 the authors released sequels to the first report entitled *Blueprint 2: Greening the world economy* and *Blueprint 3: Measuring Sustainable Development*. In June 2009, in the lead up to the UN Climate Change Conference in Copenhagen, the UN released an interagency statement supporting the green economy as a transformation to address multiple crises. In March 2010, the General Assembly agreed that green economy in the context of sustainable development and poverty eradication would form one of the two specific themes for Rio+20 (resolution 64/236). This led to a great deal of international attention on green economy and related concepts and the publication of numerous reports and other literature aiming to further define and demystify the concept. One of the key reports was the flagship *Green Economy Report* released by UNEP in November 2011 under its Green Economy Initiative. In December 2011, the UN Environment Management Group (a system wide coordination body of over 40 specialized agencies, programmes and organs of the United Nations) also released its system-wide perspective on green economy – *Working Towards a Balanced and Inclusive Green Economy* – which identifies and clarifies the use of green economy and other related terms (Allen & Clouth, August, 2012).

Theoretically this research was based on the Green Economy Report released by the United Nations Environmental Programme (UNEP) in November 2011. Based on the UNEP report in 2011, green economy is one that results in improved human well-being and social equity, while significantly reducing environmental risks and ecological scarcities. It is low carbon, resource efficient, and socially inclusive. In a green economy, growth in income and employment should be driven by public

and private investments that reduce carbon emissions and pollution, enhance energy and resource efficiency, and prevent the loss of biodiversity and ecosystem services. Theoretical background underlines the requirement of steady growth of social, economic and environmental dimensions to attain a substantial green economic performance and a green growth. Human well-being; social equity; socially inclusive; reduced inequalities; better quality of life; social development; equitable access; addressing needs of women and youth are required in social dimension to attain green economy. Growth in income and employment; public and private investments; resilient economy; economic growth; new economic activities are concerned in





economic dimension to attain a green economy. Reducing environmental risks and ecological scarcities; low carbon; resource efficient; reduce carbon emissions and pollution; enhance energy and resource efficiency; prevent loss of biodiversity and ecosystem services; within ecological limits of the planet; environmental responsibility; finite carrying capacity are essential in environmental dimension to grasp a green economy.

### **Empirical Literature**

There are several researches that examine the factors determining the green economy. There are main two group of factors that determine the green economic development. These two universal factors are: eco innovation and corporate social responsibility (Sulich, December 2018). Although several policies have been formulated to accelerate the green economy, expected outcomes have not yet been formed. The theory of green growth cannot determine the question of whether any green growth strategy or path will achieve the claims made for it. That will be an empirical matter. It is quite plausible that some environmental policies will be growth-enhancing, but others will act as a constraint. The difference could arise from the nature of the environmental problem being addressed, the stringency of the objective, or the efficiency of the policy instruments being used (Jacobs, October 2012). However, the policies implemented to attain a green economy have contributed to poverty eradication objectives in least developed countries. Those countries are well positioned in the transition to a green economy given their low carbon profile and rich natural capital assets. Key sectors for greening economies include energy access, waste, ecotourism, agriculture, sustainable urbanization and forestry (UNEP, 2011). Green growth is a tool for achieving the broader goal of sustainable development, and implies a medium- to long-term policy strategy that understands and addresses potential poverty and resource scarcity gaps; provides opportunities for fostering alternate

economic, production and livelihood models; and intends to shield development and growth prospects from future resource price volatility, as well as the impacts of environmental degradation. Green growth that is inclusive can help to implement social and sustainable development goals. However, it is highly recommended to implement broader social policies for social sector enhancement (OECD, World Bank, & United Nations, 2012). Reviewing existing literature confirms that most of countries have already formulated policies for economic empowerment and environmental conservation. Yet, most of countries have not yet focused substantial consideration to attain social development by

reducing disparities and making socially inclusiveness.

### **RESEARCH PROBLEM**

Although most of countries have formulated several policies, those countries are still unable to attain a substantial green economic performance. According to the results of the Global Green Economic Index in 2018, the percentage of the countries which have attained a significant green economic performance is only 38%. Thus, 62% of world economies have not yet attained a substantial green economic performance. Because of that, those countries have not yet reached the green economic targets. Moreover, effective and efficient policies that direct economies to environmental and economical sustainability have not yet implemented successfully. Further, this circumstance has affected negatively for the accomplishment of the Sustainable Development Goals (SDGs) as well. Existing literature proves that most of countries have not yet focused attention to the steady growth of three dimensions: Social; Economic; Environmental. Formulating balanced policies that combine all three dimensions could be the suitable solution for the inadequate green economic performance of the countries. Thus, the research problem of the current study is “is there a significant influence from the environmental performance and the economic growth to determine the current green economic performance of the world economies”

### **RESEARCH OBJECTIVES**

The primary objective of this research was to examine the overall influence of the environmental performance and the per capita gross domestic product (as a proxy to the economic growth) on the recent green economic performance of the countries. The secondary objective of the research was to provide tools for effective policy formulation which direct world economies to attain a substantial green economic performance.

### **METHODOLOGY**

This study was designed to examine the overall influence of the environmental performance and the per capita gross domestic product (as a proxy to the economic growth) on the recent green economic performance of the countries. Research was based on the deductive approach. Environmental Performance Index (EPI) has been used to measure the environmental performance of the countries. Per capita gross domestic product (GDPP) has been used as a proxy to the economic growth. Dependent variable was the Global Green Economic Index (GGEI) which measure the green economic performance of the world economies. The theoretical





form of the functional econometric model of the study is given below.

$$GGEI_t = \beta_0 + \beta_1 EPI_t + \beta_2 GDPP_t + U_t$$

Where,  $\beta_0, \dots, \beta_2$  are coefficients of independent variables;  $U$  is error term.

Above model has been estimated using cross sectional secondary data for the year 2018 covering 128 countries. Data were extracted from the Centre for environmental law and policy in Yale University, The Dual Citizen LLC and the World Bank. The operational methodology adopted is a multiple regression model. In the diagnostic tests, heteroscedasticity, multicollinearity and the normal distribution of the residuals have been checked.

## RESULTS AND DISCUSSION

According to the regression results, EPI and GDPP are positively and significantly correlated with the recent green economic performance of the countries (Table 1). This relationship can be theoretically accepted because UNEP Green Economic Report in 2011 confirms the same affiliation between those variables. Therefore, an increase in environmental performance and per capita gross domestic product has significantly influenced on recent green economic performance of the

countries. The primary objective of this research was to examine the overall influence of the environmental performance and the per capita gross domestic product on the recent green economic performance. According to the results of the model summary, Adjusted R Square is 0.431. Thus, 43% of the total variance has been explained by the estimated model. Therefore, more than 50% of the total variance of the green economic performance of countries has not been determined by the environmental performance and per capita gross domestic product. It indicates that although there is a statistically significant influence from the selected independent variables, that influence does not determine a considerable green economic performance. Further, results of the Analysis of Variance (ANOVA) confirm the statistical significance of the whole model (Table 1). The normal probability plot indicated the normal distribution of the residuals. VIF values and Tolerance confirmed that data set is out form the Multicollinearity. Heteroscedasticity has been checked by using the graphical method. The plot of squared values of the residuals and the estimated values of the dependent variable indicated a disorganized pattern.

**Table 1: Estimated Regression Coefficients**

Variable	$\beta$ Value	Std. Error	t value	sig
EPI	.002	.001	9.824	.000
GDPP	.0000141	.000	.346	.001
(Constant)	.329	.033	9.824	.000
R Square	.440	Adjusted R Square		.431
ANOVA				
F Value	49.042	sig		.000

## CONCLUSIONS AND POLICY IMPLICATIONS

This research was set out to examine the overall influence of the environmental performance and the per capita gross domestic product on the recent green economic performance of the world economies. Findings of the study reveal that the overall influence of the environmental performance and the per capita gross domestic product has not make substantial influence on the green economic performance of the world economies. Based on the findings, research concludes that the development of the Environmental, Economic and Social dimensions must be given same and balanced attention in order to attain a substantial green economic performance. Furthermore, environmental performance and the per capita gross domestic product must be improved more to make a significant green economic performance. This research suggests facilitating public and private investment that reduce the carbon

emissions and pollutions and financing more for research and development. Further, research underlines the necessity of fostering the growth of the new entrepreneurial firms and facilitating the transition to green growth in small and medium size enterprises. Moreover, based on the conclusions research recommends implementing social market economic policies that target the balanced development of environmental, economic and social sectors.

## REFERENCES

1. Allen, C., & Clouth, S. (August, 2012). *A Guidebook to the Green Economy*. Division for Sustainable Development, UNDESA.
2. Baronio, A. M. (n.d.).
3. Baronio, A. M. (2018). *Green Economy and the Dimensions of Sustainability*. *Journal of Business and Economics*, 909-914.
4. dualcitizeninc.com. (2019, December 21). Retrieved from <https://dualcitizeninc.com/global->



*green-economy-  
index/index.php#interior\_section\_link*

5. *Jacobs, M. (October 2012). Green Growth: Economic Theory and Political Discourse. London: The Grantham Research Institute on Climate Change and the Environment.*
6. *OECD, World Bank, & United Nations. (2012). Incorporating Green Growth and Sustainable Development Policies into Structural Reform Agendas. Los Cabos: OECD.*
7. *Rockstrom, J. (2009). A Safe Operating Space for Humanity. Nature, 472-475.*
8. *Sulich, A. (December 2018). The Green Economy Development Factors. Vision 2020: Sustainable Economic Development and Application of Innovation Management.*
9. *UNEP, U.-O. (2011). Why a Green Economy Matters for the Least Developed Countries. St-Martin-Bellevue, France: United Nations Environment Programme (UNEP), United Nations Conference on Trade and Development (UNCTAD), (UN-OHRLS).*



# COVID-19 AND INDIA'S FOREIGN TRADE: AN EMPIRICAL ANALYSIS OF SELECT COMMODITIES

**Rohan Prasad Gupta**

*M.Phil. Research Scholar, Department of Commerce, University of Calcutta  
32, Raj Kumar Mukherjee Road, Kolkata-700035 P.O: Alambazar, West Bengal*

## ABSTRACT

*The Covid-19 pandemic has impacted almost all the nations throughout the globe. The spread of the virus has devastating effect both on human health of masses and the economy as a whole. The nationwide lockdown in India and across the globe, to curb the spread of the pandemic, had disrupted the global supply chain and foreign trade of all the countries including India. Hence it is of utmost importance to measure the impact of lockdown on India's foreign trade. Under the study, the data relating to export and import of select major commodities belonging to the quarters ending June, 2019, March, 2020 and June, 2020 have been collected and statistically analyzed to examine the impact. The results show that there is significant decrease in exports and imports in the lockdown period. The data is analyzed and presented using two sample paired t test for means. Trade surplus/ (deficit) have also been computed to depict the overall impact of the lockdown on India's foreign trade position. Based on the conclusions drawn, certain recommendations have also been provided.*

**KEYWORDS:** Covid-19, Pandemic, Export, Import, paired t test.

**JEL Codes:** C12, C88, D53, G41, Y10

## BACKGROUND

Almost all the countries across the globe are cladding severe health and economic challenges due to the escalation of the fatal Covid-19 pandemic. To curb the spread of the virus among the masses, complete to partial shutdown of socio-economic activities has been implemented by various nations. Manufacturing units has been temporarily locked and the resulting outcome is disruption in demand and supply of goods and services, throughout the world. This has resulted into huge economic mislaying. India is one of them. Practically, all the sectors of Indian subcontinent have been affected by the spread of Covid-19 and the resultant lockdown. India's foreign trade has been drastically impacted due to the shutdown of production units. In this prevailing situation, it is important to analyze the data pertaining to exports from and imports to India, which will help to chalk out the current position of India's foreign trade and to formulate

policies accordingly. Under this study, an effort has been made to empirically analyze the Indian exports and imports of select commodities to understand the current position of foreign trade, which is believed to be having huge socio-economic significance.

## REVIEW OF LITERATURE

Agrawal, S. Jamwal, A. Gupta, S. (2020) in their research paper titled 'Effect of COVID-19 on the Indian Economy and Supply Chain' concludes that n-CoV has affected the manufacturing firms and their supply chain over the world and COVID-19 pandemic is affecting supply chains and manufacturing operations daily in India.

Singhal, A. (2020). in the research titled 'Responding to the COVID-19 Crisis: Policy Priorities for India' explained that the government would need to implement more targeted measures over the course of the next 12 months, designed to reduce costs on



business and to promote cooperation and lowering of trade barriers on goods and services used as intermediate inputs for domestic production and exports will also reduce economy wide costs for both consumers and firms, facilitating recovery from both the demand and supply-side.

Kumar, A. (2020). In his research paper titled 'COVID-19: Economic Implications and Trade Policy Responses' revealed that India's trade openness is still comparatively low compared with ASEAN nations, but still it will be difficult to escape the recession in international markets.

Banerjee, P. (2020). The research paper titled 'Enhancing Engineering Exports from India: The Case of Electrical Machinery' concludes that India must encourage domestic manufacturers to expand capacities, venture into new geographies and reach out to global manufacturers, making it attractive for them to invest in the country. This will help in inclusion of India in the global value chains.

## RESEARCH GAP

Based on extensive review of literature, it has been found that there is lack of any definite study for gaining an in-depth knowledge regarding India's position in foreign trade with respect to export and import of select commodities in this pandemic situation. The study of data relating to export and import of select commodities will depict the impact of the pandemic and the resulted lockdown on India's foreign trade. Considering this as a major research gap and having a considerable socio-economic significance; the research topic has been selected to fill up the gap through below well-defined research objectives and by conducting a descriptive, analytical and explorative research.

## RESEARCH OBJECTIVES

Based on the research gap, the following research objectives have been identified:

1. To measure the impact of lockdown on export of select commodities.
2. To measure the impact of lockdown on import of select commodities.
3. To ascertain India's trade surplus/deficit in current situation with respect to select commodities.

## RESEARCH QUESTIONS

Based on the well-defined research objectives, following research questions have been formulated:

1. Does there is any impact of lockdown on export of select commodities?

2. Does there is any impact of lockdown on import of select commodities?
3. Does there is any impact of lockdown on India's foreign trade with respect to select commodities?

## RESEARCH HYPOTHESIS

The following research hypothesis has been formulated based on the research objectives:

1.  $H_{01}$ : There is no significant difference in mean export of select commodities relating to quarter ending June, 2020 compared to quarter ending March, 2020.
2.  $H_{02}$ : There is no significant difference in mean export of select commodities relating to quarter ending June, 2020 compared to quarter ending June, 2019.
3.  $H_{03}$ : There is no significant difference in mean import of select commodities relating to quarter ending June, 2020 compared to quarter ending March, 2020.
4.  $H_{04}$ : There is no significant difference in mean import of select commodities relating to quarter ending June, 2020 compared to quarter ending June, 2019.

## RESEARCH METHODOLOGY

The present research work is based on empirical analysis of secondary data relating to export from and import to India, collected from the website of Press Information Bureau, Government of India. The study objectifies to identify the impact of Covid-19 pandemic and the resultant lockdown on export and import of select commodities and to access the overall trade position of India. Under the study, data regarding exports and imports of selected commodities relating to the quarter ending June, 2019; March, 2020 and June, 2020 have been collected. To measure the impact of nation-wide lockdown on India's foreign trade, the means of the export and import of select commodities relating to the quarter ending June, 2020 has been compared with that relating to March, 2020 and June, 2019. The comparison of means of import and export relating to select commodities will reveal that whether there is any significant impact of lockdown on India's foreign trade. For the purpose of analysis, thirty commodities related to Exports and thirty commodities relating to Imports has been selected. The paired data collected as mentioned above, are analyzed and presented using two sample paired t test for means, as the sample size is thirty, through MS Excel 2010. The sample selected is assumed to be normally distributed and hence parametric test is used here. The quarters,



mentioned above, are selected on the rationale that it will depict the true scenario of the lockdown period. Under the study, quarter ending March, 2020 represents three months relating to the pre lockdown period as the nation-wide lockdown was announced on 24<sup>th</sup> march, 2020 in India. The quarter ending June, 2020 represents three months relating to lockdown period. The quarter ending June, 2019 has been selected on the basis that the comparison made with the quarter ending June, 2020 will reveal the true year-on-year picture of foreign trade. Further, to analyze the present position of foreign

trade, six months trade surplus/deficit is also calculated and analyzed.

### DATA PRESENTATION AND ANALYSIS

To fulfill the research objectives and to answer the research questions based on the above well-defined research methodology, data regarding export and import of select commodities relating to the quarters selected are presented and analyzed below by applying two sample paired t test for means.

**Table 1: Export of Select Commodities (Rs. In Crores)**

Sl. No.	Commodities	Quarter Ending June'19	Quarter Ending March'20	Quarter Ending June'20
1	Tea	1416.77	1228.12	1023.09
2	Coffee	1554.05	1420.96	1429.99
3	Rice	12098.32	14197.88	14520.87
4	Other cereals	398	388.36	340.29
5	Tobacco	1709.63	1370.75	1382.93
6	Spices	6114.13	5904.85	6679.48
7	Cashew	897.05	936.33	564.44
8	Oil Meals	1478.4	1326.63	1365.78
9	Oil seeds	1871.53	2716.11	1751.27
10	Fruits & Vegetables	4096.63	5571.57	4435.24
11	Cereal preparations & miscellaneous processed items	2590.8	2732.63	2358.22
12	Marine Products	10653.72	9160.31	8924.77
13	Meat, dairy & poultry products	6593.96	5728.2	3667.79
14	Iron Ore	4456.97	4919.67	7919.57
15	Mica, Coal & Other Ores, Minerals including processed minerals	6509.28	6967.32	4841.15
16	Leather & leather products	8127.73	7566.29	2828.14
17	Ceramic products & glassware	4898.72	5156.87	3224.11
18	Gems & Jewellery	65392.32	57121.9	20168.38
19	Drugs & Pharmaceuticals	35113.77	36684.53	41914.87
20	Organic & Inorganic Chemicals	40259.49	39561.14	37700.72
21	Engineering Goods	144019.46	136717.63	106692.29
22	Electronic Goods	17794.41	21098.27	10815.05
23	Cotton Yarn/Fabs./made-ups, Handloom Products etc.	17533.15	17954.11	10412.12
24	Man-made Yarn/Fabs./made-ups etc.	8033.1	8872.92	3603.72





25	RMG of all Textiles	29008.41	29200.95	10955.42
26	Jute Mfg. including Floor Covering	546.37	587.78	269.58
27	Carpet	2406.54	2277.87	1350.49
28	Handicrafts excl. handmade carpet	3216.22	3112.55	1259.34
29	Petroleum Products	80540.24	66342.47	35940.62
30	Plastic & Linoleum	14428.42	12133.29	13894.06

Source: <https://pib.gov.in/PressReleasePage>.

### Analysis

H<sub>01</sub>: There is no significant difference in mean export of select commodities relating to quarter ending June, 2020 compared to quarter ending March, 2020.

H<sub>11</sub>: There is significant difference in mean export of select commodities relating to quarter ending June, 2020 compared to quarter ending March, 2020.

**Table 2: t-Test: Paired Two Sample for Means**

	<i>Quarter Ending March'20</i>	<i>Quarter Ending June'20</i>
Mean	16965.275	12074.460
Variance	795081272.553	445855204.665
Observations	30.000	30.000
Pearson Correlation	0.953	
Hypothesized Mean Difference	0.000	
df	29.000	
t Stat	2.598	
P(T<=t) one-tail	0.007	
t Critical one-tail	1.699	
P(T<=t) two-tail	0.015	
t Critical two-tail	2.045	

Source: Computed through Microsoft Excel 2010

It has been observed from the above table that t Stat (=2.598) > t Critical one-tail (1.699), with a P value of 0.007 (P < 0.05 & P < 0.01). Hence the H<sub>0</sub> (Null Hypothesis) is rejected both at 5% and 1% level of significance. This implies that there is significant difference in mean export of select commodities relating to quarter ending June, 2020 compared to quarter ending March, 2020 and the mean exports has declined considerably. This outcome is confirmed by the mean export values. The mean export value relating to quarter ending March, 2020 (=16965.275) > mean export value relating to quarter ending June, 2020 (=12074.460).

H<sub>02</sub>: There is no significant difference in mean export of select commodities relating to quarter ending June, 2020 compared to quarter ending June, 2019.

H<sub>12</sub>: There is significant difference in mean export of select commodities relating to quarter ending June, 2020 compared to quarter ending June, 2019.

**Table 3: t-Test: Paired Two Sample for Means**

	<i>Quarter Ending June'19</i>	<i>Quarter Ending June'20</i>
Mean	17791.920	12074.460
Variance	936100827.978	445855204.665
Observations	30.000	30.000
Pearson Correlation	0.936	
Hypothesized Mean Difference	0.000	
df	29.000	
t Stat	2.382	
P(T<=t) one-tail	0.012	
t Critical one-tail	1.699	
P(T<=t) two-tail	0.024	
t Critical two-tail	2.045	

Source: Computed through Microsoft Excel 2010

It has been observed from the above table that t Stat (=2.382) > t Critical one-tail (1.699), with a P value of 0.012 (P < 0.05). Hence the Ho (Null Hypothesis) is rejected at 5% level of significance. This implies that there is significant difference in mean export of select commodities relating to quarter ending

June, 2020 compared to quarter ending June, 2019 and the mean exports has declined considerably. This outcome is confirmed by the mean export values. The mean export value relating to quarter ending March, 2019 (=17791.920) > mean export value relating to quarter ending June, 2020 (=12074.460).

**Table 4: Import of Select Commodities (Rs. In Crores)**

Sl. No.	Commodities	Quarter Ending June'19	Quarter Ending March'20	Quarter Ending June'20
1	Cotton Raw & Waste	2057.96	792.07	788.72
2	Vegetable Oil	15244.51	17354.86	14641.98
3	Pulses	1680.69	2004.02	1709.3
4	Fruits & vegetables	3770.49	4615.42	2797.39
5	Pulp and Waste paper	2248.94	1952.47	1482.54
6	Textile yarn Fabric, made-up articles	3356.72	2969.6	1652.3
7	Fertilisers, Crude & manufactured	12920.72	9380.79	11766
8	Sulphur & Unroasted Iron Pyrites	189.78	131.06	138.68
9	Metaliferrous ores & other minerals	9787.34	7429.79	6760.55
10	Coal, Coke & Briquettes, etc.	47735.04	37201.09	26231.37
11	Petroleum, Crude & products	242398.55	243858.69	99259.42
12	Wood & Wood products	10897.69	8589	7511.24
13	Leather & leather products	1797.21	1681.13	900.72
14	Organic & Inorganic Chemicals	42098.91	32976.03	30533.88
15	Dyeing/tanning/colouring materials	5756.72	4674.54	3818.23



16	Artificial resins, plastic materials, etc.	28000.35	24370.57	17793.92
17	Chemical material & products	13994.81	12956.22	12519.33
18	Newsprint	1409.85	1008.22	944.03
19	Pearls, precious & Semi- precious stones	41174.9	38302.78	7716.84
20	Iron & Steel	30515.74	21655.86	19194.98
21	Non-ferrous metals	24811.35	22063.24	15367.4
22	Machine tools	8183.27	6631.41	4397.74
23	Machinery, electrical & non-elcetrical	65902.37	64731.11	40855.7
24	Transport equipment	22703.62	45464.2	14697.54
25	Project goods	3178.81	4945.09	2154.46
26	Professional instrument, Optical goods, etc.	8819.89	8611.97	6258.11
27	Electronic goods	97069.65	81870.55	58094.72
28	Medicinal & Pharmaceutical products	11886.17	10378.43	11839.54
29	Gold	79652.75	37315.94	5208.41
30	Silver	7293.91	3078.41	4358.11

Source: <https://pib.gov.in/PressReleasePage>.

### Analysis:

H<sub>03</sub>: There is no significant difference in mean import of select commodities relating to quarter ending June, 2020 compared to quarter ending March, 2020.

H<sub>13</sub>: There is significant difference in mean import of select commodities relating to quarter ending June, 2020 compared to quarter ending March, 2020.

	<i>Quarter Ending March'20</i>	<i>Quarter Ending June'20</i>
Mean	25299.819	14379.772
Variance	2107422090.222	427731122.333
Observations	30.000	30.000
Pearson Correlation	0.942	
Hypothesized Mean Difference	0.000	
df	29.000	
t Stat	2.189	
P(T<=t) one-tail	0.018	
t Critical one-tail	1.699	
P(T<=t) two-tail	0.037	
t Critical two-tail	2.045	

Source: Computed through Microsoft Excel 2010

It has been observed from the above table that t Stat (=2.189) > t Critical one-tail (1.699), with a P value of 0.018 (P < 0.05). Hence the Ho (Null

Hypothesis) is rejected at 5% level of significance. This implies that there is significant difference in mean import of select commodities relating to quarter ending



June, 2020 compared to quarter ending March, 2020 and the mean imports has declined considerably. This outcome is confirmed by the mean import values. The mean import value relating to quarter ending March, 2020 (=25299.819) > mean import value relating to quarter ending June, 2020 (=14379.772).

H<sub>04</sub>: There is no significant difference in mean import of select commodities relating to quarter ending June, 2020 compared to quarter ending June, 2019.

H<sub>14</sub>: There is significant difference in mean import of select commodities relating to quarter ending June, 2020 compared to quarter ending June, 2019.

**Table 6: t-Test: Paired Two Sample for Means**

	<i>Quarter Ending June'19</i>	<i>Quarter Ending June'20</i>
Mean	28217.957	14379.772
Variance	2234736594.836	427731122.333
Observations	30.000	30.000
Pearson Correlation	0.928	
Hypothesized Mean Difference	0.000	
df	29.000	
t Stat	2.602	
P(T<=t) one-tail	0.007	
t Critical one-tail	1.699	
P(T<=t) two-tail	0.014	
t Critical two-tail	2.045	

Source: Computed through Microsoft Excel 2010

It has been observed from the above table that t Stat (=2.602) > t Critical one-tail (1.699), with a P value of 0.007 (P < 0.05 & P < 0.01). Hence the H<sub>0</sub> (Null Hypothesis) is rejected both at 5% and 1% level of significance. This implies that there is significant difference in mean import of select commodities relating to quarter ending June, 2020 compared to

quarter ending June, 2019 and the mean imports has declined considerably. This outcome is confirmed by the mean import values. The mean import value relating to quarter ending June, 2019 (=28217.957) > mean export value relating to quarter ending June, 2020 (=14379.772).

**Table 7: Monthly Exports, Imports and Trade Surplus/ (Deficit) (Rs. In Crores)**

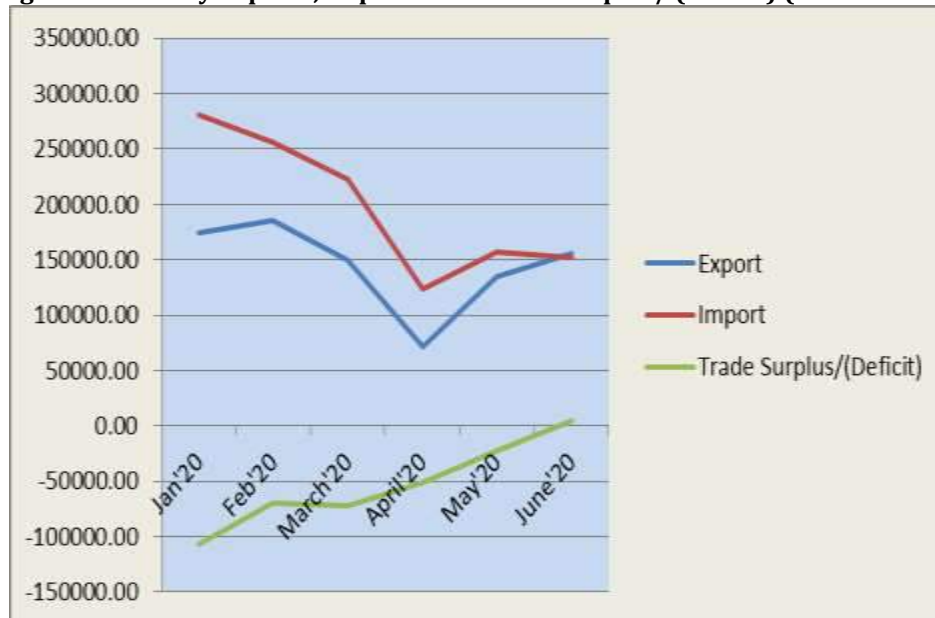
Months	Export	Import	Trade Surplus/(Deficit)
Jan'20	173695.54	281041.71	(107346.17)
Feb'20	185677.20	255883.97	(70206.77)
March'20	149585.52	222068.88	(72483.36)
April'20	71822.64	123031.18	(51208.54)
May'20	134797.31	156890.36	(22093.05)
June'20	155613.84	151471.61	4142.23

Source: <https://pib.gov.in/PressReleasePage>.

**Analysis:**

It is observed from the above table that there was trade deficit for all the five months, that is, from January, 2020 to May, 2020. But, in the month of June, 2020 there is trade surplus of Rs. 4142.23. It is also observed that both the exports from and imports to

India has declined significantly from the month of January, 2020 to June, 2020. The month of April, 2020 was the worst hit in terms of foreign trade as both export and import of select commodities have declined significantly. This is depicted in the figure below:

**Figure 1: Monthly Exports, Imports and Trade Surplus/ (Deficit) (Rs. In Crores)**

Source: Computed through Microsoft Excel 2010

## CONCLUSION

The empirically analysis of data relating to exports from and imports to India with respect to select commodities and the statistical results clearly indicates that both exports and imports have decreased in the quarter ending June, 2020, that is, the lockdown period as compared to its previous quarter ending March, 2020, that is, pre lockdown period as well as the quarter ending June, 2019. The overall foreign trade has declined in the lockdown period, that is, for the months of April, May and June, 2020. The month of April, 2020 is worst hit because of the complete shutdown of the manufacturing units. This has resulted in reduction in demand for raw materials from abroad leading to reduced imports. The reduced production has disrupted the supply side also. Moreover, the lockdown has resulted into reduced purchasing power of the masses, the outcome for which is decrease in imports of non-essential commodities. The demand for crude oil has also reduced considerably resulting into lower imports. Moreover, the lockdown throughout the world has hampered the global supply chain which has impacted India's foreign trade also. The month of May and June, 2020 reflects that there is some recovery in the foreign trade position. The major cause of such outcome is that the government allowed operating some manufacturing units with reduced manpower. In the month of June, 2020, India witnessed trade surplus with respect to select major commodities, which is a positive signal for the Indian economy.

## RECOMMENDATION

On the basis of the conclusions drawn from the statistical results, it is evident that both the exports from and imports to India have reduced significantly relating to select major commodities. However the trade deficit is also reducing which is an eminent point of discussion. The month of June, 2020 experienced a trade surplus which is considered to be a positive breakthrough for the Indian economy. The government of India has initiated certain steps for export promotion such as Remission of Duties or Taxes on Export Products (RoDTEP) which will help those exporters who have already taken orders, tax credit to MSMEs, to fulfill the demands for more export finance, the export credit guarantee corporation will offer higher insurance cover and will expand the funds disbursed to banks which are ultimately lent to exporters. Other measures initiated by the central government such as the daily monitoring of exports data, qualitative support, export aids and grants to IT sector operating in SEZs, etc. will have positive impact on exports. Apart from this, it is recommended that this is the time to encourage and extend considerable support to the MSME sector so that they can re-start their operations, which will help in increasing exports. Industries operating in the preview of producing import substitute products must be supported with adequate financial and technical assistance. It is also recommended to focus on developing local supply chains which will definitely decrease international dependence for raw material





requirements and will reduce imports and will improve the overall foreign trade position of India.

### LIMITATION AND FUTURE RESEARCH SCOPE

The present research is based on the empirical analysis of select major commodities relating to exports and imports. The analysis of export and import of services and other components of Balance of Payment has not been considered under the present study. The accurate assessment impact of such deadly Covid-19 pandemic on India's foreign trade will require a time frame of six to twelve months. There is an enormous future scope of research under this subject with more components and expanded time frame.

### REFERENCES

1. Agrawal, S.; Jamwal, A.; Gupta, S. *Effect of COVID-19 on the Indian Economy and Supply Chain*. Preprints 2020.
2. Singhal, A. (2020). *Responding to the COVID-19 Crisis: Policy Priorities for India*. *COVID-19 Challenges for the Indian Economy: Trade and Foreign Policy Effects*. EPIC INDIA. Pg- 101-104.
3. Kumar, A. (2020). *COVID-19: Economic Implications and Trade Policy Responses*. *COVID-19 Challenges for the Indian Economy: Trade and Foreign Policy Effects*. EPIC INDIA. Pg- 105-108.
4. Banerjee, P. (2020). *Enhancing Engineering Exports from India: The Case of Electrical Machinery*. *COVID-19 Challenges for the Indian Economy: Trade and Foreign Policy Effects*. EPIC INDIA. Pg- 173-178.
5. <https://economictimes.indiatimes.com/news/economy/foreign-trade/indian-begins-export-of-major-farm-items-amid-covid-19-lockdown->
6. <https://www.eepcindia.org/COVID-19-government-guidelines-and-notifications.aspx>
7. [https://www.business-standard.com/article/economy-policy/fm-sitharaman-announces-new-measures-here-are-the-key-steps-taken-119091400619\\_1.html](https://www.business-standard.com/article/economy-policy/fm-sitharaman-announces-new-measures-here-are-the-key-steps-taken-119091400619_1.html)
8. <https://www.businesstoday.in/current/economy-politics/coronavirus-impact-govt-steps-in-to-support-export-industry-amid-job-loss-fears/story/400775.html>
9. <https://pib.gov.in/PressReleasePage.aspx?PRID=1638804>



# HOUSEHOLDS FUELWOOD CONSUMPTION IMPACT ON FOREST DEGRADATION IN THE CASE OF MOTTA DISTRICT, NORTHWEST ETHIOPIA

**Mulatu Mengist**

*Ethiopian Environment and Forest Research Institute, P.O.Box: 24536 code 1000 Addis Ababa, Ethiopia*

Article DOI: <https://doi.org/10.36713/epra4763>

## ABSTRACT

*Traditional energy sources like fuelwood, charcoal, cow dung, and crop residue are common for household domestic energy consumption in the majority people of the study area as well as in Ethiopia. However, information related the impact of household fuelwood consumption on forest degradation is limited in the study area. Therefore, the aim of this study was to examine the impacts on households' domestic fuelwood consumption on deforestation and forest degradation in Motta district northwest Ethiopia. A random sampling procedure was employed to select 140 sample households involved in the household survey. Then open ended and close ended semi structured questioners were provide for each sample household. In addition, sample bundle of fire wood and sack of charcoal were measured to quantify households' traditional measuring unit into standardize biomass unit. Descriptive statistics and multiple linear regression was performed to examine household fuelwood impact on forest degradation and for identifying main determinant factors affecting households' daily fuelwood consumption. . The result revealed that farmers owned plantation is the main source of fuelwood consumption a species like *Eucalyptus globulus*. Annually they consumed 2.36 kg/household. Hence, the total communities consumption was around 3,635.51ton dried biomass of fuelwood which is estimated about 1.89 hectare of forest land is degraded due to households' domestic energy consumption in the study area. The statistical regression analysis also revealed family size and their residence far from fuelwood source had statistically significant different. It is confirmed that household fuelwood consumption had negatively impact of forest resource development and accelerate deforestation and forest degradation rate. Hence, in order to solve deforestation and forest degradation due to forest dependence energy consumption; providing other alternative energy accessibility like electricity, solar energy, biogas, improved cook stove are recommended.*

**KEYWORDS:** *Fuelwood, Charcoal, Forest degradation, Household energy, Household*

## 1. INTRODUCTION

Woody biomass is one of the main sources of domestic energy by satisfying the growing energy demand of Africa people /developing countries (cities). Almost half of the world's population and nearly 81% of Sub-Saharan Africa (SSA) depend on woody biomass energy especially for cooking, household, heating and other homestead activities (AFREAP, 2011). In global context about 55% of the wood extracted from forests is which is responsible for 5% of global deforestation (Miles and Dickson, 2010), while; in developing countries the

consumption of fuelwood account more than 75% of wood harvested from forest is used as domestic fuelwood purpose (Bearer et al., 2008). Increasing consumption of fuelwood has caused in an approaching crisis in scarcity of fuelwood in world (Macht and Axinn, 2007). The Consumption of traditional fuels has negative environmental, economic and health impacts on local communities as well as the worldwide, That leads to deforestation and forest degradation following ecological imbalance and increasing the use of agricultural residues and animal dung deprives the land of



essential nutrients necessary for soil fertility (Geissler et al., 2013).

In Ethiopia traditional biomass consumption (fuelwood, charcoal, dung, and crop residue) in household's level accounts approximately 90% of total primary energy use (Mekonnen and Köhlin, 2009). In line with this biomass is the major source of cooking fuel for urban and rural household which accounts about 84% and 99% from the total energy consumption, respectively (MEFCC, 2016). Currently, most of Ethiopian households depend overwhelmingly on biomass for cooking in rural areas and even in most urban areas households have upgraded their biomass use (Damte et al., 2012).

In recent years peoples who lived in urban areas starting uses of electricity as a source of energy but still there is higher biomass fuelwood consumption like charcoal, branches and leaves which accounts more than 105172465ton/yr; from 2000 to 2013 the charcoal demanding of the country increased from 48,581 to 4,132,873 tons/year (Geissler et al., 2013). This indicate that household domestic fuelwood consumption has a great impacts on changes of forest land cover type (Negasi et al., 2018). Similarly, the growing demand of fuel wood as source of energy increase the rate of forest degradation and deforestation in the country. (Berhanu et al., 2017).

Socioeconomics characteristics, environmental characteristics and technology affected the household's fuelwood consumption. Household size is a significant variable that directly influence fuelwood consumption (Mekonnen, 1997, Mitku and Yi, 2020). Household's residence far from fuel source negatively affected the daily fuelwood consumptions, the people who lived in sufficient available fuel wood area or nearby forest relatively consumed higher fuel wood as compared to the other. (Ullah and Tani, 2017). However, studies related to the impact of household fuel wood consumption on forest deforestation and degradation is limited in the study area.

Therefore, this study design to examine the households' domestic fuelwood consumption for cooking and heating consumption impact on forest degradation and deforestation in study area, North West Ethiopia., It is expected to quantifying household mean daily woody biomass consumption and estimating the amount of forest depletion annually for domestic energy purpose. It also provide information for policy makers, governmental and non-governmental organization which are working on afforestation and reforestation, Environmental protection, energy conservation program, and suggest other source of energy to decrease the pressure on forest for fuelwood purpose in the study area as well as the reference for all over Ethiopia.

## 2. METHODS AND MATERIALS

### 2.1. Study area

The study was conducted in northwest Ethiopia Amhara Regional State East gojjam zone in Motta district specifically Sedie worda Andnet Mariyam kebele<sup>1</sup>, which is about 373 Km from the Capital city of Ethiopia, Addis Ababa. Geographically: UTM (1104'47"N - 11007'40"N latitude and 37036'38"E - 370 45'00"E) longitude with altitude of 1800m a.m.s. (Figure-1). It has mostly two agro-ecological zones, namely Woina-Dega Dega Two main seasons characterize the study site. The first one is long rainy season which lasts from June to end of September and locally known as Kiremt. The second known as Bega, it is the rest of months and it is the season where the main harvest and land preparation activities have been practiced. The short rain at this season from March to May is very important for planting and sowing crop. The land use pattern is under categorized of cultivated, grazing, forests and shrubs, residence and others, and non- utilized respectively in the district. Livestock, crops and forest products are the mains ources farmers income. *Zea mays*, *Eragrostis tef*, *Triticum*, *Lens culinaris*, *Hordeum vulgare*, *Glycine max*, and *Sorghum bicolor* are crops that mainly grown in the study area under rain fed conditions. Livestock's also the main integral components of the farming system and fixed assets. Sheep, Goat, Chickens and Cattle, Donkey, Horse, and Mule. Forests and shrubs which dominantly *Eucalyptus globulus* plantation, *Acacia decurrens*, *Acacia abyssinica*, *Cupressus lustitanica* and from natural forest both shrubs and trees.

<sup>1</sup> Kebele is the smallest administration unit in Ethiopia

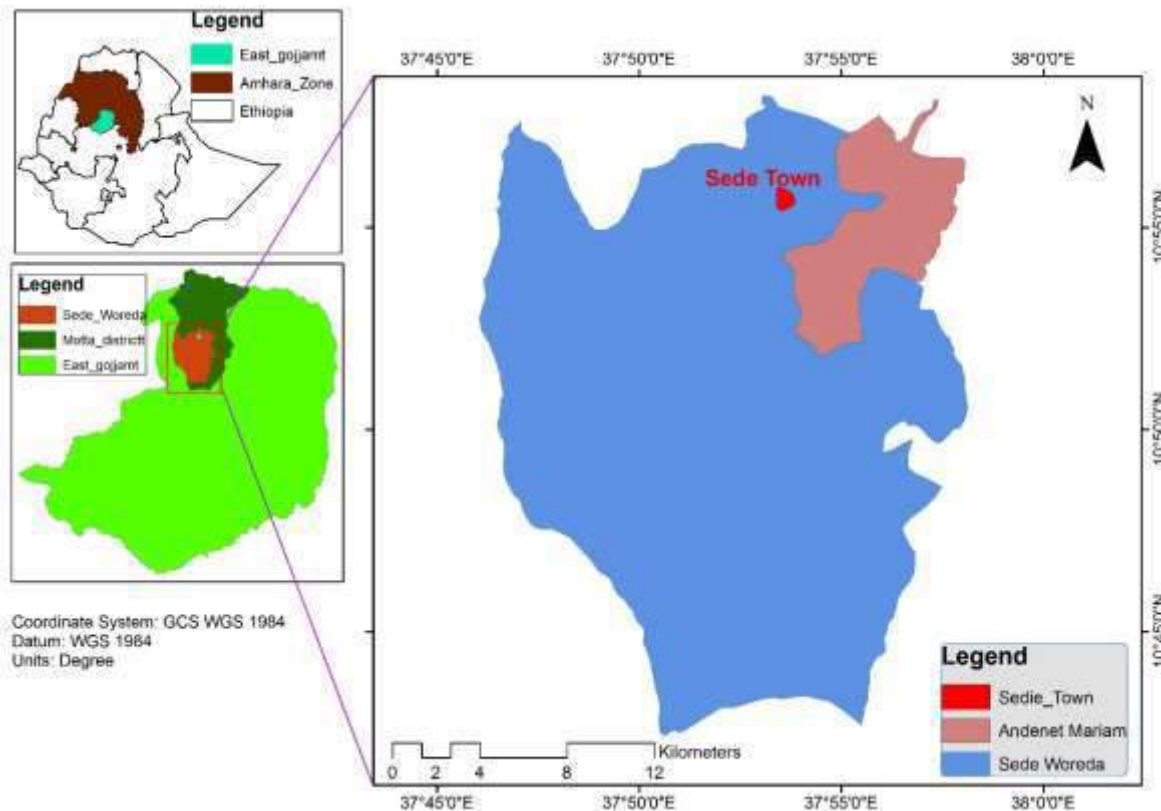


Figure 1. Map of the study area Motta district Sedie woreda Andinet Mariam kebele

## 2.2. Sampling techniques and sample size

The purposive sampling method was employed to obtain sample kebeles, in which there was successive selection of the household within the population. Sample household selection was done according to simplified formula provided by Yamane (1967) and revised by (Israel, 2012). There were 1353 total household in the kebele. Accordingly, the sample households from target population at 92%, confidence level 0.08(8%) level of precision. Totally 140 households were conducted to get the required data.

$$n = \frac{N}{1 + N(e)^2}$$

Where n is the sample size, N is the population size, and e is the level of precision at 92% at significance level 0.08.

## 2.3. Data sources

For this study, both primary and secondary data sources were collected in the form of quantitative and qualitative information. Primary data was collected through a household survey, focus group discussion, and key informant interview in the

form of open and close-ended questioners were provided by the local language Amharic. Information such as household socioeconomic characteristics, mean daily fuelwood and charcoal consumption, most commonly used tree species for domestic energy use, source of fuelwood, field observation was done and crossed checked survey data by focus group discussion and key informant interview. Secondary data was collected from Woreda administration offices and Kebele agriculture office, and reviewing literatures from published and unpublished materials that supported the finding of this study.

## 2.4. Variables and model specification

Based on the main aim study the impact of households' fuelwood consumption on forest degradation and increasing deforestation rate multiple linear econometrics model on households' mean daily fuelwood consumption was analyzed statistically by using STATA software.

### 2.4.1. Variables

**Dependent variable:** It is a continuous variable in mass of mean daily fuelwood of both fire wood and charcoal consumption in kilogram. The households' fuel wood consumption was found by questioner survey directly for each individual households in terms of local measurement unit bundle of fire wood and sack of charcoal. Then to convert the equivalent biomass by taking 70 bundles



of fire wood and 50 sack of charcoal in local market weighted in kilogram for calculating the mean daily consumption dried biomass for each households. The determinant factors of households fuelwood consumption shown below and expected effect (Table.1)

**Independent variables:** The explanatory variable in this test are household's socioeconomics

characteristics and other determinant factors in household daily fuelwood consumption. Household's socioeconomics characteristics like Sex, age, education status, family size, residence far from fuelwood source may have significance difference on perception regarding fuel wood extraction and environment degradation (Ullah and Tani, 2017, Mitku and Yi, 2020).

**Table 1. Independent variables, their description, type and expected effects on linear model**

Variables	Description	Type	Expect effect
FWCON	HH Fuelwood Consumption in KG	Continuous	Dependent Variable
Sex HHH	Sex Of HH Female=0 Male= 1	Dummy	+/-ve
Age HHH	Age of HHH in Years	Continuous	+/-ve
EDUC	Schooling years HHH	Continuous	- ve
HHSIZE	Number of people in HH	Continuous	+ve
DISFWS	Distance from home to fuelwood source	Continuous	-ve

HHH: household headed

### 2.4.1. Model specification

Statistically analyzing the impact of explanatory variables on household fuelwood consumption econometrics model builds as follow.

$$FWC = \beta_0 + \beta_1 (SEX) + \beta_2 (Age) + \beta_3 (Hsize) + \beta_4 (Educ) + \beta_5 (DFWS) + \epsilon$$

Where, FWC is dependent variables denoted mean daily household fuelwood consumption

Sex = Sex of the household headed (1= male, 0 = female)

Age = Age of the household headed (year)

Hsize = Number of person live in one households (N)

Educ = Educational status of the household headed in schooling year

DFWS = Households residence from fuelwood source (km)

" $\beta_i$ " is vector parameters to be estimated.

" $\beta_0$ " is the constant term, and

" $\epsilon$ " is the error term

## 3. RESULTS

### 3.1. Household characteristics

The data from the household survey revealed that 82.86% the respondents' were male-headed households, and the rest 17.14% were female-headed, the mean age of the household headed was 43.16 year with a range of 29 - 68 years old, the average family size in one household was 4.82 person with 2 and 8 person minimum and maximum respectively, the educational status of a household headed by schooling year averagely was 2.99 with the range of 0 - 10 years minimum and maximum schooling years, and the households settlement far from the main fuelwood source that is either plantation of natural forest averagely was found 1.25 kilometer with the range of 0.35- 5.5 km in the study area (Table.2).

**Table 2. Summary of households' characteristics**

Variable	Observation	Percent	Mean	Std. Dev.	Min	Max
HHH Sex	140	100	-	-	-	-
Male	111	79.29	-	-	-	-
Female	20.71	20.71	-	-	-	-
HHH Age (Yr.)	140	-	45.58	12.03	26	71
Fam size(N)	140	-	5.94	2.03	2	10
HHH Education (yr.)	140	-	2.99	2.19	0	10
Distance from fuelwood source(Km)	140	-	2.82	1.29	0.5	5.5

### 3.2. Household fuelwood consumption

Based on the results found from household's survey the mean daily firewood consumption per household was 6.45 kg dried biomass which indicates the annual fuelwood consumptions per household

was 2,361.55 kg/household's equivalent about 2.36 ton. Accordingly; the total fire wood consumption of all households in the study area found about 3,193.08ton dried biomass.





Charcoal is also another forest dependence households' domestic energy source, which isn't most common in the study area. Some households used charcoal for only coffee and tea making purpose. The result from household survey revealed that the mean annual charcoal consumption of the household was two sacks, which is equivalent to 60kg of charcoal. According to Rensselear (2010) report to produce 1kg of charcoal needs 5.45kg of wood biomass. Hence, 327 kg of dried biomass is needed to produce 60kg of charcoal. Accordingly; the dried biomass consumption in the study area to be estimated 442,431kg (442.43ton). In general, the total households' fuelwood biomass consumption in the study area was found about 3,635.51ton of dried biomass for fire wood and charcoal. (442.43ton). Finally, the total households' fuelwood biomass consumption in the study area was found about 3,635.51ton of dried biomass both from fire wood and charcoal.

### 3.3. Fuelwood impact on forest degradation

The estimation of forest depletion was calculated by considering the most common tree species used for fuelwood purposes in the study area that is *Eucalyptus globulus*. In Ethiopia most people are dependent on Eucalyptus tree species as a source of fuelwood (Teketay, 2000). According to Tatek et al. (2018) on Comparative growth performance study of fast-growing tree species for wood fuel production in highland area of Ethiopia *Eucalyptus globulus* was the one which planted by 1.5x1.5m shown good growth performance with 86% survival rate. Furthermore; it indicates that *Eucalyptus globulus* can planted for fuelwood purpose 4,489 tree/hectare. Out of this assume 70% of the trees will become matured, and expected to be 3,142 trees per hectare.

Hence, the result found from household survey was 3,635.51 ton dried biomass for local communities' fuelwood consumption. As work of Fantu (2005) revealed that dry matter of above ground biomass (AGB) single tree including components of stem wood, branch, foliage, and bark of *Eucalyptus globulus* was found 613 kg/tree with a diameter at breast height and height range of 15-34 cm and 18.8-43.6 m respectively. Consequently, annually forest deforested area for domestic

households' fuelwood consumption to be estimated around 5931matured tree, which is equivalent to about 1.89 hectare/year *Eucalyptus globulus* plantation forest in the study area. Similarly, Berhanu et al. (2017) indicates in south western Ethiopia fuel wood utilization impacts on forest resources implied that 1.76 ha of forest resources was consumed per annum for fuel wood by the community members.

### 3.4. Factors affecting households fuelwood consumption

The multiple linear regression result indicated that male household headed have consumed more fuelwood than female headed, family size has positively relationship with fuelwood consumption, while Age, Education level and households residence far from main fuelwood source have negatively relationship with daily fuelwood consumption. Unfortunately, only family size and household's residence distance from main fuelwood source had statically significant difference on fuelwood consumption between the sample households and the proportion of the variation in dependent variable explained by explanatory variables(R-squared) is 0.6930 (69.3%). household family size has positive relationship, education level and distance to sources of fuel wood collection had negative relationship to fuel wood consumption of household (Kasim et al., 2020).

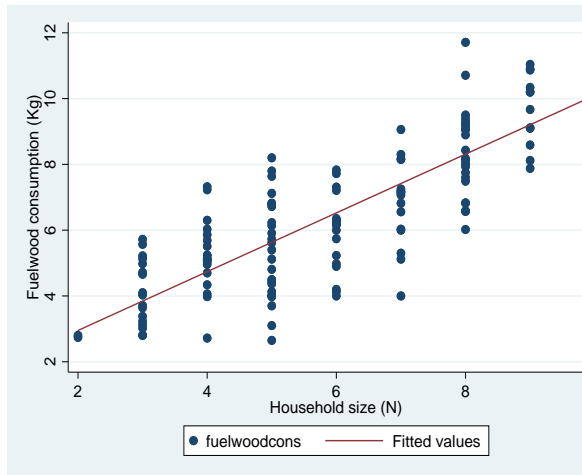
The result obtained from the linear regression model indicated that the number of people live in the HH had a statistically highly significant difference at (p< 1%) level of significance (Table. 3). The result suggests that the fuelwood consumption of households' with one more person living in the family will be increased by about 0.94kg fuelwood per day which have a direct relationship with each other (Figure-2).

The distance from the residence of the household to fuelwood source had statistically significant effect on the household's fuelwood consumption at a significance level (p< 5%) (Table. 3) The result further indicate that as the distance from the residence of the household to fuelwood source increased by one kilometer, the household fuelwood consumption decrease by 0.19kg of wood in daily consumption. The dependent and independent variable had negatively relationship (Figure-3).

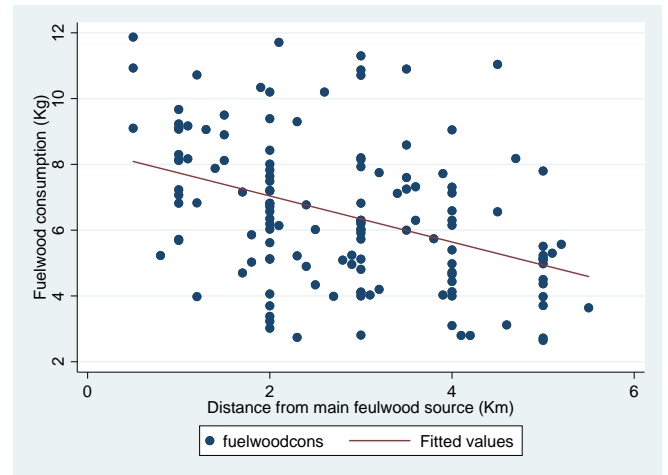
**Table 3. Multiple linear regression model**

fuelwoodco~n	Coef.	Std. Err.
HHHsex	0.38	0.26
HHHage	-0.02	0.013
Famsize	0.94	0.08***
Education	-6.6E <sup>-05</sup>	0.048
DFWS	-0.19	0.089**
_cons	2.03	0.61

\*\*\* & \*\* show standard error significant at 1% and 5% significance level respectively



**Figure 2. The relationship between fuelwood consumption and household size**



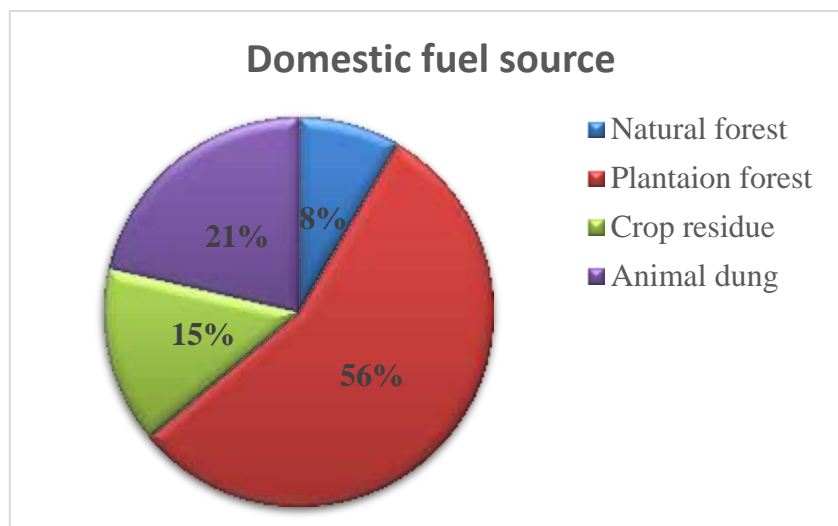
**Figure 3. The relationship between fuelwood consumption and distance from fuelwood source**

### 3.5. Fuelwood source

In the study area, the proportion of household's domestic fuel energy source for cooking and baking purpose was 57.47% from plantations (homestead plantation trees) as major source of fuel. 21.38% cow dung, 14.71% crop residual which is collected after farmers harvesting there agricultural crops mainly maize cane and cobs, and about 8.44 % from illegal harvesting of natural forest (Figure. 4).

The results from households survey, Key informant interview, and field observation was

found that from plantation forest *Eucalyptus globulus* was the most commonly used tree species (72.1%) used for households domestic energy consumption which is followed by *Acacia decurrens*, *Acacia abyssinica*, and others like *Eucalyptus camaldulensis*, *Vernonia amygdalina*, *Ricinus communis...* etc. The main reason for using *Eucalyptus globulus* was associated with its fast-growing and better adaptive nature to the local agro-ecology, and furthermore most people in Ethiopia are dependent on the Eucalyptus as a source of fuelwood (Teketay, 2000).



**Figure 4. Source of traditional fuel for domestic energy consumption in the study area**

## 4. DISCUSSION

Fuel wood remains the main energy source for the majority of the people in Ethiopia. As compared to the situation in the past, the forest cover is now generally very sparse in the densely populated areas where rapid rates of deforestation

and forest degradation have occurred due to the heavy demand on forest products, mainly fuel wood ( Berhanu et al., 2017). Clearing forest areas to expand agricultural land and tree cutting for fuel wood, timber and agricultural implements were the main causes for the decline of forest cover in the



region (Gebreegziabher, 2007). Household fuelwood collection has great impacts on changes of forest land cover types (Negasi et al., 2018).

The provision of wood energy is generally concluded to be a highly impacts to forest loss (Roubik et al., 2018). Forest biomass resources from private farmland (homestead) plantation are the main source of fuel wood in many rural areas of Ethiopian. Households with little or no land may face severe restrictions on access to fuels and some local communities harvest natural forest illegally for fire wood and charcoal production. Currently, Ethiopian government identified tree growing or afforestation, both at community household levels and as policy strategy to decrease deforestation and degradation, because of the deforestation that has occurred over many years scarcity of fuelwood is a critical problem in Ethiopia (Gebreegziabher and Kooten, 2013).

Socioeconomics characteristics, environmental characteristics and technology determinant factor for the household's fuelwood consumption. Household size is a significant variable that directly influence fuelwood consumption (Mekonnen, 1997; Ullah, S. and Tani, 2017; Ararsa, 2019). Household's residence far from fuel source affected the daily fuelwood consumptions. Moreover, fuel wood consumption is determined by the availability of fuel wood source for the local people. For example the people who have sufficient fuel wood inside their homestead or lived near by the forest utilized relatively more fuel wood than the other peoples. (Ullah and Tani, 2017). Subsequently, the easy accessibility of wood sources from the surrounding area are often increase the consumption of fuelwood and highly accelerate the rate of deforestation and forest degradation (Roubik et al., 2018). In the same while, the opportunity cost of collecting fuel wood increases with increasing distance to its sources away from home time consumed could be more for collection and harvesting less fuelwood. (Guta, 2014).

## 5. CONCLUSION

The finding of this study revealed that fuel wood consumption has negative impact on forest resource conservation and accelerate deforestation and forest degradation rate in the study area. The households energy source was found mainly from plantation forest specifically *Eucalyptus globulus* is the most common tree species for domestic energy consumption. In recent years the forest land coverage is changed to agricultural land and bar land due to population increment and highly demanded for forest products for energy purpose.

This indicate even though forest is a renewable natural resource, its overuse can lead rapidly and straightforwardly to shortages.

Household size and households residence distance from the main fuelwood source was the main determinant factors that affects households' fuelwood consumption in the study area. This study will help to design forest conservation by ensuring sustainable utilization of forest resource and assuring another alternative energy source for household domestic energy purpose. Providing another modern energies like electricity, solar energy, biogas and improving cooking stove application can decrease household's forest dependence and approved balanced usage of limited natural resource in the study area as well as all over Ethiopia.

## REFERENCES

1. *Africa Renewable Energy Access Program (AFREAP). (2011). Wood-based biomass energy development for Sub-Saharan Africa: Issues and approaches. Washington, D. C.: World Bank.*
2. *Alemu, G. (2017). Role of biogas technology in forest conservation and carbon emission reduction in wondo genet district, sidama zone, southern Ethiopia. Msc Dissertation Hawassa University, Ethiopia.*
3. *Amigun, B. and Von Blottnitz, H. (2010). Capacity-cost and location-cost analyses for biogas plants in Africa. Resources, Conservation and Recycling, 55(1), pp.63-73.*
4. *Ararsa, D. (2019). Domestic biogas digester as a means of wood fuel consumption reduction in the rural households of Wondo Genet, Southern Ethiopia.*
5. *Bearer, S., Linderman, M.; Huang, J.; An, L.; He, G.; Liu, J. (2008). Effects of fuelwood collection and timber harvesting on giant panda habitat use. – Biological Conservation 141: 385-393.*
6. *Berhanu, N, Debela, H, and Dereje, B. (2017). Fuel wood utilization impacts on forest resources of Gechi District, South Western Ethiopia. Journal of Ecology and The Natural, Vol. 9(8), , pp. 140-150, August 2017.*
7. *Damte A, Koch SF, Mekonnen A. (2012). Coping with fuel wood scarcity: household responses in rural Ethiopia. Environment for development discussion paper series, Efd DP, 12-01.*
8. *Fantu, W. (2005). Above Ground Biomass Allometric Equations and Fuel wood Properties of Six Species in Ethiopia. Ph.D. dissertation, University of Putra, Malaysia.*
9. *Gebreegziabher, Z. (2007). Household fuel consumption and resource use in rural-urban Ethiopia PhD Thesis Wageningen University. .*
10. *Gebreegziabher, Zebene and G. Cornelis van Kooten. (2013). Does community and household tree planting imply increased use of wood for fuel? Evidence from Ethiopia. Forest Policy and Economics, 34, 30-40.*
11. *Geissler S, Dietmar Hagauer PM, Alexander H, Michael K, Peter S. (2013). Biomass Energy*



- Strategy Ethiopia., AMBERO Consulting Gesellschaft mbH Immanuel-Kant-Str. 41, 61476 Kronberg i. Ts.
12. Guta, D. (2014). *Effect of fuelwood scarcity and socio-economic factors on household bio-based energy use and energy substitution in rural Ethiopia*. *Energy policy*, 75, pp.217-227.
  13. H. Roubik, J.Mazancova, A.Brunerova and D. Herak. (2018). *Factors influencing use of fuelwood and its environmental impacts in Tapanuli Utara regency, North Sumatra*. *Agronomy Research* 16(S1), 1228-1236, 2018 <https://doi.org/10.15159/AR.18.095>.
  14. Israel, G. D. (2012). *Determining Sample Size, Agricultural Education and Communication Department, Florida Cooperative Extension Service, Institute of Food and Agricultural Sciences, University of Florida*.
  15. Kasim Adem Mohammed, Cherinet Seboka Ambaye and Kemal Nure Kawo. (2020). *Evaluation of Fuel Wood Consumption and Its Implication to Forest Degradation in Agarfa Wereda, South-Eastern Ethiopia*. *Journal of Resources Development and Management* Vol.62, 2020.
  16. Macht, C and W. Axinn. (2007). *Household Energy Consumption: Community Context and Fuelwood Transition*. Michigan, USA, University of Michigan, Population Studies Centre, Institute for Social Research: 23pp.
  17. Mekonnen A and Köhlin G. (2009). *Determinants of household fuel choice in major cities in Ethiopia*.
  18. Mekonnen, A. (1997). *Rural household fuel production and consumption in Ethiopia: A case study: Department of Economics, Göteborg University, Goteborg, Sweden*.
  19. Miles, L. and Dickson, B. (2010). *REDD-plus and biodiversity: opportunities and challenges*.
  20. Ministry of Environment, Forest and Climate Change (MEFCC). (2016). *National Forest Sector Development Program, Ethiopia Volume II: Program Pillars, Action Areas and Targets* PP. 49, (MEFCC).
  21. Mitku Alemu Mengistu and Yi Xie. (2020). *Impacts of Livestock Holdings on Households' Decision to Participate in Wood Fuel Production from Dryland Forest (Case study in Dire Dawa; Ethiopia)*. (d. 10.11648/j.ajere.20200501.13, Ed.) *American Journal of Environmental and Resource Economics*, Vol. 5, No. 1, 2020, pp. 14-20.
  22. Negasi Solomon, Hadgu Hishe, Ted Annang, Opoku Pabi, Isaac K Asante, and Emiru Birhane. (2018). *Forest Cover Change, Key Drivers and Community Perception in Wujig Mahgo Waren Forest of Northern Ethiopia*. *MDPI Land* 2018, 7(1), 32; <https://doi.org/10.3390/land7010032>.
  23. Tatek D. , Berhane K. Tinsae B., Mihret S., Kibruyesfa S., and Egual T. (2018). *a Comparative growth performance of fast-growing tree species for woodfuel production in highland area of Ethiopia*. *Horticulture International Journal* 2018;2(6):309–316. DOI: 10.15406/hij.2018.02.00069.
  24. Teketay, D. (2000). *Facts and experiences on eucalypts in Ethiopia and elsewhere: ground for making wise and informed decision*.
  25. Ullah, S. and Tani, M. (2017). *Fuelwood Consumption and its Impact on Forests in the Teknaf Peninsula on the Southern Coast of Bangladesh*.





## **IN THE EYES OF THE BEHOLDER: STUDENTS' PERCEPTION OF STUDENT-TEACHERS CLASSROOM BEHAVIOUR AND COMPETENCIES IN ABIA STATE**

**Udechukwu, Jonathan (Ph.D.).**

*Department of Human Kinetics, Health and Safety Education, Faculty of Natural and Applied Sciences, Ignatius Ajuru University of Education, Port Harcourt, Rivers State, Nigeria.*

**Kanelechi C.K. Nwangwa (Ph.D.).**

*Director of Academic Planning and Quality Assurance, Clifford University, Owerri, Abia State.*

### **ABSTRACT**

*This study investigated the extent of students' perception of student-teachers' classroom behaviour and competencies during the teaching practice exercise in Abia State. The study identified four classroom behaviours which were lesson presentation, classroom management, use of teaching aids, and student-teachers' personality. Based on these behaviours, four research questions and their corresponding null hypotheses were used to guide the study. The descriptive survey research design was used while a sample of 304 students drawn through purposive sampling technique was used for the study. A research-developed instrument composed of 20-items was used for data collection, which was accessed for validity by experts. Cronbach Alpha reliability yielded a value of 0.87 which showed that the instrument possessed a suitable level of reliability for use. Data collected was analyzed using mean and standard deviation to answer the research questions, while independent samples t-test was used to test the null hypotheses at 0.05 level of significance. Result revealed that student-teachers exhibited poor lesson presentation and use of teaching aid, while they exhibited a commendable level of classroom management and positive personality traits. Based on the result obtained, it was recommended that students' assessment should be integrated into the grading of student-teachers during the teaching practice exercise.*

### **INTRODUCTION**

Beyond the attaining of knowledge, education is a veritable tool that has been considered important for the pursuit of sustainable development of individuals, societies and nations. While various definitions exist, education has generally been seen as the process of impacting and attaining new forms of knowledge, skills and attitudes to aid an individual or group of individuals towards becoming productive members of the society (Abdul-Kareem, 2001). It is therefore from this background that every modern society has made massive human and capital investment into the educational development of its

citizen. One area in which investment in education has become most pressing is the aspect of teacher education. This is because the educational development of any society rests squarely on teachers. As Okoli (2011) asserted, no society can grow beyond the quality of its teachers. Commenting further, Ukeje (1988) opined that it is the teacher who will ultimately be responsible for translating policy into action, principles into practice and curriculum into learning. Recognizing that no nation can grow beyond the quality and commitment of its teachers, it has become necessary that teacher education is given adequate attention, effectively monitored and sufficiently financed.





The realization that teachers are foundationally essential for the development of education and society in general, it has become pertinent that there are timely and available training and retraining programmes for teachers (Afe, 1992). Teacher education programmes must be seen as not only a national duty but a sacred obligation that must be given financial and policy priority. While various teacher development programmes have been proposed and implemented, one approach that has enjoyed both historical and universal acceptance is the utilization of teaching practice programmes for pre-service teachers, as this provides becoming teachers the opportunity to translate educational learning principles and policy into classroom learning for students.

Teaching practice exercise occupies a central position in the teacher preparation process. Both globally and in Nigeria, it is generally acknowledged that going into the teaching profession without undergoing teaching practice is a recipe for professional disaster and educational failure, not only for the teacher but also for the student they interact with. It was therefore against this background that the Federal Government of Nigeria (2007) through the National Universities Commission (NUC) and the National Commission for Colleges of Education stipulates that all students in faculties of education at the university level and those in colleges of education must undergo, at least, a compulsory teaching practice exercise. This has remained a statutory requirement for students to be graduated. Furthermore, performance in teaching provides a basis for predicting the future success of teachers, and thus Oluwatayo and Adebule (2012) posited that teaching practice is an indispensable aspect of teacher education process.

While conceptualized differently and operationalized based on local preference, teaching practice is common in all modern societies. According to Ogunyinka, Okeke and Adedoyin (2015), teacher education refers to the professional education of teachers towards the attainment of attitudes, skills and knowledge considered desirable to make them efficient and effective in their work, in accordance with the need of a given society at any point in time. It generally includes training, evaluation and programmes that occurs before the commencement or entrance into the teaching profession. Teaching practice programme provide prospective teachers with the opportunity to translate content knowledge, lesson presentation skills, use of teaching aids, classroom management competencies and learners behaviour into actual practice.

During teaching practice, student-teachers are expected to plan and deliver their lessons appropriately using a mixture of pedagogical theories and classroom principles. Good lesson planning recognizes flexibility while also providing prospective teachers with structure and substance (Pollard, 2006). Planning involves the formulation of concise and feasible learning objectives, appropriate organization of content areas and effective use of subject matter terminologies. A central goal of lesson planning involves the formulation of learning objectives linked to specific activities which determine learners' progress and is used to assess the extent of learning.

To effectively attain the lesson objectives, it is fundamental that teachers make use of teaching aids. Teaching aids help in reinforcing the skills, knowledge, facts or ideas presented in the classroom. According to Creneti (2012), it is acknowledged that effective use of relevant and quality teaching aids by student-teachers provides arousal of students' interests, relieving students' anxiety and creates enthusiasm for the subject matter. Specifically, the current generation of students prefers the use of teaching and learning aids such as charts, models, scientific equipment, video and audio cassettes, radio, television, projectors, multimedia information and communication technology (ICT) according to Riegel and Mete (2018). Thus the need for student-teachers to embrace the use of such media for enriching, broadening and deepening the learning experiences for those they may teach. It is therefore incumbent on student-teachers to identify and utilize the most appropriate teaching aids to illustrate and clarify the intents of the lesson so that the learners can understand the importance of each concept.

Another aspect of teaching practice that student-teachers must develop is the effective management of pupils. According to Seweje (2000), teachers, including student-teachers need to understand that the classroom is all about helping the students learn rather than making the teacher the centre of attraction. As such, the teachers must have the ability and authority to control the behaviour of students as well as ensure orderliness. Furthermore, teachers must use a variety of instructional techniques to draw and sustain the attention of students and encourage active participation. All these are made possible through the personality of the student-teacher. A teacher with a warm, amiable and friendly personality is more likely to promote interest among students. On the other hand, the teacher whom students consider harsh, critical and unfriendly is likely to create resistance and instil anxiety among students.



The importance of the above skills and competencies for student-teachers such as lesson preparation and presentation, classroom management, use of teaching aids, and teachers' personality can only be observed and improved upon through the ample provision of opportunities to practice. Therefore, according to Nakpodia (2011, p. 34), the aim of practice teaching is to give student-teachers the opportunity of learning at first hand the actual work of a teacher in typical classroom situations. It provides the student-teacher with the opportunity to meet learners as they are and to practice the theories acquired in pre-service training. To further identify if the aim of teaching practice has been effectively executed, student-teachers must be evaluated.

Normally, student-teachers are assigned to schools for a specific timeframe for them to undertake their teaching practice. During this period, student-teachers are visited by their lecturers to observe the students on different criteria of teaching such as lesson preparation and presentation, classroom management, use of teaching aids and personality of the trainee-teachers. A major goal of these visitations is to assess the extent to which learning theories and classroom principles earlier learnt by the student-teacher can be used in designing and deploying learning objectives among students they teach. Unfortunately, the supervisors posted to such schools can only visit periodically and not regularly. Considering the challenge of funding and logistics, it is recommended by Hamilton-Ekeke (2016) that supervisors should visit at least three times during the period of the teaching practice. It is also suggested that such visitations should be to provide guidance and assessment of the prospective teacher, rather than victimizing student-teachers. Sadly, there have been reoccurring cases of abuse of the supervisory process where supervisors fail to visit the students and thereafter manufacture scores. Other supervisors see this as an opportunity to victimize students whom they considered "stubborn" or indiscipline, while others appease student-teachers by providing undeserved grades in order to gain cheap popularity among them (Hamilton-Ekeke, 2016). It has, therefore, become pertinent to provide an alternative form of assessment of student-teachers from the perspective of the student they teach. It was against this background that the current study was conducted.

### **STATEMENT OF THE PROBLEM**

Despite the fact that education is the key lever that drives individual and national development, it has only been given lip service within the Nigerian context, especially in the area of teacher education. There has

been a shortage of an adequate number of teachers, with the few making transition from student to teachers lacking the needed skills and competencies needed to effectively perform efficiently on the job. Many student-teachers find it difficult to effect the necessary behavioural changes needed to transit from student role to teacher role, especially those who are engaging in teaching for the first time. Moreover, there is a problem of agreement in the rating of teaching performance of student-teachers by the assessors as there may be demerits of leniency or harshness. Finally, the current practice of assessing students by supervisors might yield an artificial outcome as student-teachers would have prepared the class setting to impress the supervisors. Considering the above challenges and the possibility that students who are taught by student-teachers observe them throughout the period, it is highly possible that such students can provide a better assessment of pre-service teachers than supervisors who visit infrequently. It is against the backdrop of these problems, that the current study seeks to investigate the perception of students on the classroom behaviour of student-teachers during the teaching practice exercise in Abia State.

### **AIM AND OBJECTIVES OF THE STUDY**

The purpose of this study was to investigate the perception of students on the classroom competencies and behaviour of student-teachers during the teaching practice exercise in senior secondary schools in Abia State. To guide this study, the following specific objectives were made:

1. Assess the perception of students on student-teachers lesson presentation during the teaching practice exercise in senior secondary schools in Abia State.
2. Investigate the perception of students on student-teachers classroom management during the teaching practice exercise in senior secondary schools in Abia State.
3. Ascertain the perception of students on student-teachers use of teaching aid during the teaching practice exercise in senior secondary schools in Abia State.
4. Evaluate the perception of students on student-teachers personality during the teaching practice exercise in senior secondary schools in Abia State.

Based on the above-listed objectives, the following research questions were developed

1. What is the perception of students on student-teachers lesson presentation during the



teaching practice exercise in senior secondary schools in Abia State?

2. What is the perception of students on student-teachers classroom management during the teaching practice exercise in senior secondary schools in Abia State?
3. What is the perception of students on student-teachers use of teaching aid during the teaching practice exercise in senior secondary schools in Abia State?
4. What is the perception of students on student-teachers personality during teaching practice exercise in senior secondary schools Abia State?

In answering the above research questions, the following null hypotheses were tested at 0.05 level of significance to confirm the findings of the study:

1. There is no significant difference in the perception of public and private school students on student-teachers lesson presentation during teaching practice in senior secondary school in Abia State.
2. There is no significant difference in the perception of public and private school students on student-teachers classroom management during teaching practice in senior secondary school in Abia State.
3. There is no significant difference in the perception of public and private school students on student-teachers use of teaching aid during teaching practice in senior secondary school in Abia State.
4. There is no significant difference in the perception of public and private school students on student-teachers personality during teaching practice in senior secondary school in Abia State.

## METHODOLOGY

**Research Design:** The research design adopted for the study was the descriptive survey research design. This design was deemed appropriate for this study because the researcher was only interested in surveying the perception of students on the classroom competencies and behaviour of student-teachers posted to their school.

**Population of the Study:** The population of the study was comprised of all the students taught by student-teachers during the first term of the 2019/2020 academic session in the five local government areas of Abia State. This period coincided with the period which student teachers were assigned to schools for the teaching practice exercise by various institutions

including the Federal College of Education, Obudu. The total number of students could not be ascertained due to logistics and operational consideration.

**Sample and Sampling Technique:** To arrive at an appropriate sample, the purposive and convenience sampling technique was used. The researcher obtained the names of schools where student teachers were assigned to in Abia State. From these schools, a total number of 304 students voluntarily agreed to respond to the instrument for data collection. These students assessed a total of 53 student-teachers in 23 schools. The schools were both public and private. Furthermore, only students in SS II were used for the study because this researcher believes that they can adequately respond to the items under consideration.

**Instrument for Data Collection:** The instrument for data collection was a researcher-developed instrument titled Students' Perception of Classroom Behaviour of Student-Teachers Inventory (SPCBSTI). The instrument was a 20-item structured questionnaire which was divided into two broad sections titled A and B. Section A of the instrument was designed to elicit responses on demographic data from the respondents such as their gender, school type, name of student-teacher being assessed. Section B of the instrument which was designed in a modified Likert scale of Very High Extent (VHE), High Extent (HE), Low Extent (LE) and Very Low Extent (VLE) which were scored 4, 3, 2 and 1 points. This section was further divided into four sections assessing the classroom behaviour of lesson preparation, classroom management, use of teaching aid and student-teachers' personality with five items each. This instrument was made simple compared to that used by supervisors so that students can readily provide their opinion.

The instrument was validated by experts from the Departments of Educational Management and Educational Psychology, Guidance and Counselling from the Ignatius Ajuru University of Education, Port Harcourt. They validated the items in terms of clarity of language, sentence structure, relevance of the items to the study and content coverage. Their suggestions and modifications were integrated into the final version of the instrument before administration. For reliability, copies of the instrument were administered on 30 students taught by student-teachers in Northern ABIA State. Data obtained were subjected to Cronbach Alpha method of reliability analysis and this yielded a value of 0.87 which is indicative of a suitable level of reliability.

**Data Collection and Analysis Procedure:** For data collection, the researchers along with two research assistants, administered the instrument to the



respondents in the sampled schools. Copies of the questionnaire were distributed to the respondents within a period of three weeks. The copies distributed were collected on the same day immediately after completion from the respondents to ensure optimal retrieval rate.

## RESULTS

**Research Question One:** What is the perception of students on student-teachers lesson presentation during the teaching practice exercise in senior secondary schools in Abia State?'

**Table 1: Perception of students on lesson presentation of student-teachers**

S/N	Item	Mean	SD	Decision
1	Clearly state objective before lesson presentation	1.90	0.97	VLE
2	Mastery of subject and content areas	2.98	1.01	HE
3	Development of different aspects of the lesson	2.09	1.09	LE
4	Logical Presentation of content	2.80	1.01	HE
5	Effective usage of time	1.83	0.97	VLE
	Grand Mean	2.32	1.01	LE

From the result displayed in Table 1, the perception of students on the lesson preparation competencies of student-teachers during the teaching practice exercise was documented. According to the result, a grand mean of 2.31 (SD = 1.01) was obtained on lesson preparation ability of student-teachers. Based on this result, it,

therefore, indicates that student-teachers exhibit lesson preparation to a low extent in Abia State.

**Research Question Two:** What is the perception of students on student-teachers classroom management during the teaching practice exercise in senior secondary schools in Abia State?'

**Table 2: Perception of students on classroom management of student-teachers**

S/N	Item	Mean	SD	Decision
6	Class participation during lessons	3.10	0.97	VHE
7	Classroom control of disruptive behaviour	3.06	0.99	VHE
8	Classroom arrangement	2.96	1.05	HE
9	Reinforcement of pupils' response	2.94	1.07	HE
10	Creates collaboration among student	3.17	1.01	VHE
	Grand Mean	3.05	1.02	VHE

From the result displayed in Table 2, the perception of students on the classroom management competencies of student-teachers during the teaching practice exercise was documented. According to the result, a grand mean of 3.05 (SD = 1.02) was obtained on classroom management ability of student-teachers. Based on this result, it, therefore, indicates that student-

teachers exhibit classroom management competencies to a very high extent in Abia State.

**Research Question Three:** What is the perception of students on student-teachers use of teaching aid during the teaching practice exercise in senior secondary schools in Abia State?'

**Table 3: Perception of students on the use of teaching aid among student-teachers**

S/N	Item	Mean	SD	Decision
11	Selection of lesson aid matches the topic presented	1.85	0.98	VLE
12	Use of various teaching aids	1.93	1.05	VLE
13	Relate the teaching aid to the topic under discussion	1.92	1.04	VLE
14	Encourage students to develop their own teaching aid	1.89	1.09	VLE
15	Develop personal teaching aid for students	2.94	1.09	HE
	Grand Mean	1.98	1.05	VLE

From the result displayed in Table 3, the perception of students on the effective use of teaching aids among

student-teachers during the teaching practice exercise was presented after data analysis. According to the



result, a grand mean of 1.98 (SD = 1.05) was obtained on classroom ability of student-teachers to effectively use teaching aid. Based on this result, it, therefore, indicates that the use of teaching aids was to a very low extent among student-teachers in Abia State.

**Research Question Four:** What is the perception of students on student-teachers personality during teaching practice exercise in senior secondary schools Abia State?

**Table 4: Perception of students on the student-teachers personality of student-teachers**

S/N	Item	Mean	SD	Decision
16	Neatness	3.15	0.72	VHE
17	Friendliness	2.74	0.72	HE
18	Approachable	2.91	0.81	HE
19	Consistent	2.63	0.92	HE
20	Encouraging	3.04	0.72	VHE
	Grand Mean	2.89	0.78	HE

From the result displayed in Table 4, the perception of students on the student-teachers personality during the teaching practice exercise was presented after data analysis. According to the result, a grand mean of 2.89 (SD = 0.78) was obtained on of student-teachers personality during the teaching practice exercise. Based on this result, it, therefore, indicates that student-

teachers personality was considered suitable to a high extent in Abia State.

#### Test of Hypotheses

**Hypothesis One:** There is no significant difference in the perception of public and private school students on student-teachers lesson presentation during teaching practice in senior secondary school in Abia State.

**Table 5: Independent samples t-test of perception of students on lesson presentation skills of student-teachers during teaching practice**

School Type	N	Mean	SD	Df	t-cal	p-value	Alpha	Decision
Public	200	2.08	0.82	302	1.25	0.211	0.05	Retain
Private	104	2.31	0.77					Ho <sub>1</sub>

From the result shown in Table 5, it is shown that when the mean ratings of public school student (mean = 3.08, SD = 0.82) and private school students (mean = 2.31, S.D = 0.77) on their perception of lesson presentation among student-teachers were subjected to independent samples t-test, a t-value of 1.25 was obtained with a corresponding p-value of 0.211 which was greater than 0.05 level of statistical confidence. Based on this result, it can be stated that public and private school students

do not differ significantly in their perception of student-teachers lesson presentation. The null hypothesis is therefore retained.

**Hypothesis Two:** There is no significant difference in the perception of public and private school students on student-teachers classroom management during teaching practice in senior secondary school in Abia State.

**Table 6: Independent samples t-test of perception of students on classroom management skills of student-teachers during teaching practice**

School Type	N	Mean	SD	df	t-cal	p-value	Alpha	Decision
Public	200	3.13	0.71	302	0.577	0.56	0.05	Retain
Private	104	2.98	0.84					Ho <sub>2</sub>

From the result shown in Table 6, it is shown that when the mean ratings of public school student (mean = 3.13, SD = 0.71) and private school students (mean = 2.98, S.D = 0.84) on their perception of classroom management among student-teachers were subjected to independent samples t-test, a t-value of 0.577 was obtained with a corresponding p-value of 0.56 which was greater than 0.05 level of statistical confidence. Based on this result, it can be stated that public and private school students do not differ significantly in their perception of student-teachers classroom management skills. The null hypothesis is therefore retained.





**Hypothesis Three:** There is no significant difference in the perception of public and private school students on student-teachers use of teaching aid during teaching practice in senior secondary school in Abia State.

**Table 7: Independent samples t-test of perception of students on the use of teaching aid of student-teachers during teaching practice**

School Type	N	Mean	SD	df	t-cal	p-value	Alpha	Decision
Public	200	1.64	0.83	302	2.19	0.03	0.05	Rejected
Private	104	2.43	0.87					Ho <sub>3</sub>

From the result shown in Table 7, it is shown that when the mean ratings of public school student (mean = 1.64, S.D = 0.83) and private school students (mean = 2.43, S.D = 0.87) on their perception of the use of teaching aid among student-teachers were subjected to independent samples t-test, a t-value of 2.19 was obtained with a corresponding p-value of 0.03 which was lesser than 0.05 level of statistical confidence. Based on this result, it can be stated that public and

private school students differ significantly in their perception of student-teachers' use of lesson aid. The null hypothesis is therefore retained.

**Hypothesis Four:** There is no significant difference in the perception of public and private school students on student-teachers personality during teaching practice in senior secondary schools in Abia State.

**Table 8: Independent samples t-test of perception of students on student-teachers personality during teaching practice**

School Type	N	Mean	SD	df	t-cal	p-value	Alpha	Decision
Public	200	2.14	0.79	302	2.56	0.01	0.05	Reject Ho <sub>4</sub>
Private	104	2.96	0.83					

From the result shown in Table 8, it is shown that when the mean ratings of public school student (mean = 1.64, S.D = 0.83) and private school students (mean = 2.43, S.D = 0.87) on their perception of student-teachers' personality were subjected to independent samples t-test, a t-value of 2.56 was obtained with a corresponding p-value of 0.01 which was lesser than 0.05 level of statistical confidence. Based on this result, it can be stated that public and private school students differ significantly in their perception of student-teachers personality during teaching practice. The null hypothesis is therefore retained.

and may resort to off-task behaviour in the classroom. This result is similar to that obtained by Oluwatayo and Adebule (2012) who found out that student-teachers skill in lesson preparation was very low in Ekiti State University, Ekiti State. Furthermore, the result showed that there this finding is similar both in public and private secondary schools.

It was also shown that student-teachers had a very high extent of classroom management skills. This result implies that most the students were rated as having effective classroom management skill such as encouraging class participation during lessons, classroom control of disruptive behaviour, adequate classroom arrangement, reinforcement of pupils; response and enables collaboration among students. The findings of this study were obtained in both public and private schools which means that both student teachers assigned to public and private schools exhibit a high level of classroom management techniques. This result is similar to those obtained by Nwanekezie et al (2011) that student-teachers in the University of Port Harcourt had effective classroom management skills when interacting with students during teaching practice exercises.

Furthermore, the result showed that student-teachers use teaching aids to a very low extent. The implication of this is that student-teachers fail to use appropriate teaching aid and do not incorporate

## DISCUSSION OF FINDINGS

From the result obtained after the analysis of data, it was revealed that there is a low extent of students-teachers effective presentation of lessons during the teaching practice exercise. Furthermore, there is no significant difference in the perception of public and private secondary school teachers on the extent of lesson presentation among student-teachers during the teaching practice exercise. This result implies that students do not have adequate skills for lesson presentation such as to clearly state lesson objectives, development of different aspects of a lesson, and effective usage of item. The resultant effect would be that students would lose track of the lesson



teaching aids that match topics taught and presented. This result might be attributed to the poor skills of student-teachers to develop their own instructional materials as well as guide students on how to develop local instructional materials. The findings of this study are similar to that obtained by Nzilano (2013) who found that pre-service teachers from the University of Dar es Salaam, Tanzania had limited competencies in the use of teaching aids during their teaching practice exercise.

Finally, it was shown that student-teachers' personality was considered positive to a very high extent. It, therefore, indicates that the students displayed qualities such as neatness, friendliness, consistency and encouragement. The findings of this research question showed that student-teachers personality could help improve the learning potential of the students they teach. This finding aligns with that obtained by Aydin, Bavli, and Alci (2013) who found out that pre-service teachers' personality has a significant role to play in both their development and those of the students they teach.

## RECOMMENDATIONS

Based on the findings obtained, the following recommendations were therefore made:

1. Currently, what is in practice in terms of assessment of student-teachers is the report and grading from their supervisors only. This practice is not comprehensive enough as the supervisor visit the student-teacher approximately three times in the six weeks of the teaching practice. The supervisors' assessment only will not be adequate. It is therefore recommended that students' assessment should be integrated into the grading of student-teachers during the teaching practice exercise.
2. Faculty should have a micro-teaching laboratory where students will be well exposed to the rudiments of teaching.
3. There should be teaching practice handbook for the students to have a uniform method of writing lesson notes. Rules and regulations of practical teaching will also be stipulated in this handbook.
4. Stakeholders in teaching practice in colleges of education and universities should formally induct their student-teachers on the importance of the exercise to teacher education to ensure satisfactory teaching performance of the students.

## REFERENCES

1. Abdul-Kareem, A. Y. (2001). *Nigeria university and the development of human resources*. In N. Nwagwu, E. T. Ehiemetolor, M. A. Ogunu & M. Nwadiani (Eds). *Current issues in Education Management in Nigeria*. Benin City: Amik Press.
2. Afe, J.O. (1992). *Trends in teacher education: The case of colleges of Education in Nigeria*. In Eimuhi J.O. and Otomewho, G.A (Eds.) *Access, Equity and Quality in Higher Education*. NAEP Publication.
3. Aydin, M. K., Bavli, B. & Alci, B. (2013). *Examining the effects of pre-service teachers' personality traits on their teaching competencies*. *International Online Journal of Educational Sciences*, 5(3), 575-586.
4. Creneti, J. (2012). *Types of teaching aids*. Retrieved from <http://www.ehow.com>. 1999-2012.
5. *Federal Government of Nigeria (2007). National Universities Commission: Benchmark minimum academic standards for undergraduate programmes in Nigerian universities in Education*. Retrieved from <http://fcezaria.edu.ng/tarkace/nuc.pdf>
6. Hamilton-Ekeke, J. (2016). *Evaluation of teaching practice in Nigeria*. *European Journal of Education Studies*, 2(12), 156-164.
7. Nakpodia, E. D. (2011). *Teacher and the student practice teaching programme in Nigerian educational system*. *International Journal of Educational Administration and Policy Studies*, 2(3), 33-39.
8. Nwanekezi, A. U., Okoli, J. N. & Meziobi, S. A. (2011). *Attitude of Student-Teachers towards Teaching Practice in the University of Port Harcourt, Rivers State, Nigeria*. *Journal of Emerging Trends in Educational Research and Policy Studies*, 2(1), 41-46.
9. Nzilano, J. I. (2013). *Pre-service teachers' teaching competencies: The experience of practicing teaching in secondary schools and teacher colleges*. *African Journal of Teacher Education*, 3(1), 1-21.
10. Ogunyinka, E. K., Okeke, T. I. & Adedoyin, R. C. (2015). *Teacher education and development in Nigeria: An analysis of reforms, challenges and prospects*. *Education Journal*, 4(3), 111-122.
11. Okoli, N. (2011). *Towards a Revolutionary Education and Teacher Development in Some Selected African Countries*. *LWATI: A Journal of Contemporary Research*, 8(1). Retrieved from <https://www.ajol.info/index.php/lwati/cart/view/79711/69987>
12. Oluwatayo, J. A. & Adebule, S. O. (2012). *Assessment of Teaching Performance of Student-teachers on Teaching Practice*. *International Education Studies*, 5(5), 109-115.
13. Pollard, A. (2006). *Reflective teaching*. 2nd edition. London: British Library.



14. Riegel, C. & Mete, R. (2018). A closer look at educational technologies for K-12 learners: What digital natives can teach digital immigrants and what digital immigrants can teach digital natives. *Educational Planning Journal*, 24(4), 49-58.
15. Seweje, R. O. (2000). The challenge of science teaching in Nigeria today. *Journal of Educational Foundations*, 1(1), 208-220
16. Ukeje, I. (1988) Training teachers to recognize and identify gifted children- Inner City Gifted Project. Paper presented at the annual workshop for the Inner City Gifted Project, Newark, NJ.



# ETHNOGRAPHIC STUDIES ON THE HISTORY OF THE LEFT-BANK KAT-QALA: MYTHS AND LEGENDS

**Sadullaev B.P.**

*Senior Researcher, Khorezm Mamun Academy, Khiva*

## ABSTRACT

*This article is dedicated to the results of ethnographic studies of the history of the left-bank Kat-qala. The researches, conducted by G.P. Snesev with the representatives of the local population near this monument and in Beruni city on the right bank of the Amu Darya river, testifies the relation direct of the history of the left-bank Kat-qala with the ancient capital Kyat. In particular, the abundance of the myths and legends associated with Sheikh Abbas Vali in studies indicates how important this character was in the history of these monuments. This information mainly refers to the subsequent 300-year history and ideas about the ancient places of the population of the new (left bank) Kat-qala, were preserved in memories up to the present days. Ethnographic studies also show the position of representatives of the Uzbek clan of the population of ancient Kat-qala in the political life of the khanate, and this is evident of their resettlement in a new built fortress. Left-bank Kat-qala as one of the largest fortresses always had a particular value in the history of the Khanate. Once the ancient capital city Kat-qala on the right bank of the Amu Darya river, gradually forgotten from the memory of the people and the toponym Shabbaz is formed instead. And we can see by the legends associated with Sheikh Abbas Vali, how important his name was in the formation of this toponym.*

**KEY WORDS:** *G.P. Snesev, Shabbaz Baba, Sheikh Abbas Vali, left-bank Kat-qala, the ancient capital Kat, Khorezm legends, Shavat.*

## INTRODUCTION

We know that in the process of exploring each historical monument, we come across folk oral heritage, including legends and myths, associated with its name or the history of its construction. The object we are studying is the Kat-qala archeological monument located on the left bank of the lower Amu Darya basin. The monument is located 25 km northwest of Urgench, in the territory of Kat-qala mahalla of Shavat district. Traces of the trapezoid-shaped monument walls are clearly visible as a hill. The legends and myths about the history of this castle have not been studied as a separate subject and have not been generalized as an object of study.

The myths and legends associated with the Left Bank Kat-qala are very short and unrelated. It is difficult to generalize them. Nevertheless, we cite the myths and legends collected in the course of

ethnographic research as an integral part of the history of the monument.

The importance of this information for the history of the monument is enormous, covering mainly the processes associated with the history of the castle over the next 300 years. The left-bank (new) Kat city under study shows that the ancient capital is directly related to the history of Old Kat on the right bank. In this regard, the results of ethnographic research conducted by the Khorezm archeological ethnographic expedition in Khorezm region under the leadership of G.P. Snesev are very important [Tolstov et al. 1963, 22; Arjanceva 2016, 233-234].

## LITERATURE ANALYSIS

Studies show that most of the information about the history of the monument, although brief, was mainly reflected in the research of G.P. Snesev. For many years, as part of the Khorezm



archeological ethnographic expedition, in the process of studying the ethnography of the Uzbeks of the Khorezm oasis, special attention was paid to the history of place names, their origin, myths and legends. Myths and legends related to the history of the left bank Kat-qala were reflected in his scientific monographs, including "Pre-Islamic beliefs and customs of Khorezm Uzbeks" [Snesarev 1969], "Khorezm legends as a source on the history of religious beliefs in Central Asia" [Snesarev 1983]. In the process of studying myths and legends, information about the name and history of the monument has been comparatively studied with the sources given in the works "History of irrigation of Khorezm" [Gulyamov 1959], "Toq-kala" [Gudkova 1964], "Ancient Khorezm defense structures" [Khojaniyozov 2007] and "Tazkiratul avliyo, i.e. mentions of the saints in Khorezm" [Qamariddin Eshon Muhammad Karim Eshon oghli, Komiljon Durdi Qilich oghli 1997, 6-7].

## RESEARCH MATERIAL

G.P. Snesarev's first research on the history of monuments was carried out in 1958-1960. The Uzbek ethnographic group led by the researcher, in the course of research in the territory of Shavat district of Khorezm region, also collects some information about the monument by talking to the representatives of the population around the left bank Kat-qala [Snesarev 1983, 58, 126-129; Snesarev 1969, 30, 284].

In one of the legends, this city was the scene of the heroism of the legendary Rustam, who is depicted in Iranian epics as a brave warrior, and no doubt, the story of this image was influenced by Firdavsi's work "Shahname". According to the legend, he comes to Kat to avenge his murdered grandfather. Brave Rustam, in the appearance of a salt trader, enters the city with his soldiers and takes revenge on the ruler who killed his grandfather. This plot is reminiscent of the plot of the conquest of Misqala (Copper fortress) in the "Shahname" [Snesarev 1983, 58]. At the same time, the leading plot of this legend also seems to have been taken from Siyavush's motive for revenge. If Siyavush's activity is connected with Khorezm, the popularity of the motive of revenge in the legends of the oasis is of special importance [Snesarev 1969, 284].

When we talk about the construction of this or that ancient city and fortress of Khorezm, we also come across legends about giants in historical legends. The image of the giant is often embodied in the image of the builder, the creator. The Shahname states that King Jamshid forced the giants to mix mud, make bricks and construct buildings, thus creating architecture [Snesarev 1969, 62]. The

legendary kings of Khorezm also used them to build their famous cities and fortresses. Legends about giants are widespread in the formation of some monuments in Khorezm (Chilpik, Toq-kala). They are directly reflected in the toponymy of many monuments (Devkesgan (Giant cut), Devsolgan (Giant built), Dev-qala (Giant fortress)) [Gulyamov 1959, 35; Gudkova 1964, 150; Khojaniyozov 2007, 17-18; Snesarev 1969, 29-30, 62].

G.P. Snesarev in his data collected from the elders during the ethnographic research in Shavat district notes that there is also a legend associated with giants in the construction of the left bank Kat-qala. According to the legend, Kat-qala was built by giants overnight. That is why the people called it "Devsolgan qala" [Snesarev 1969, 30].

Even, today, the name "Devsolgan" is mentioned in the talks with some of the older representatives of the population of Kat-qala village in Shavat district. Besides, Pirov Ilhom, a retired teacher at School No. 5 in the village, said he had heard from the elders that the left-bank Kat-qala was called Devsolgan.

In G.P. Snesarev's researches in ethnographic field, the legend associated with the old Kat on the right bank, is often studied in direct connection with the Kat on the left bank [Snesarev 1983, 125-129]. Especially important stories among the myths and legends formed in the last centuries are the stories about Shobboz bobo (father Shobboz), which are associated with the ancient city of Kat.

It should be noted that the capital on the right bank, Kat, had been flooded by the Amu Darya many times in its history and as a result the migration of people happened very often. Abu Rayhan Beruni mentions one of these floods in his book "Monuments of the Past". During the reign of Anushakhan, another floods caused the relocation of its population to a new place. According to legends, the inhabitants of Old Kat were cursed by Shobboz bobo. For this reason, the city of Kat was frequently flooded.

It is evident that the local population was frequently exposed to such calamities, the inability to determine the cause of the floods, the weakness of man in the face of these calamities, as if these events were the basis for composing various myths and legends associated with the curse of the saint.

Today, this ancient city is named after our great ancestor, encyclopedic scientist Abu Rayhan Beruni. The name was given to the city in 1973 for the scientist's contribution to world science during the celebration of the millennium, as well as for the fact that he was born and grown around the city.





The name of the city in the late Middle Ages, that is, during the khanate period, was called Sheikh Abbas Vali and the term Shabboz was widely spread in the people's language. This is the name which is come across in the Russian maps of the 18<sup>th</sup> and 19<sup>th</sup> centuries.

Sheikh Abbas Vali is the name of a saint, the patron saint of the city. It is this legend associated with the saint, recorded by G.P. Snesarev in an interview with a local resident Pirjonov Bekim.

According to the legend, "Before Sheikh Abbas Vali, the oppressive king Daqi-Yunus ruled in Kat. All the property here was considered as his personal property. There were also slaves in the service of Daqi-Yunus. The skeletons still standing on the walls of the fortress are the slaves of Daqi-Yunus. Slaves who died during the construction of the wall were immediately thrown into the wall.

Sheikh Abbas Vali was a representative of the local population. He persuaded the slaves to revolt against Daqi-Yunus. They took revenge for their misery by seizing this oppressive king and dragging him over the thorny plants. Daqi-Yunus could not bear this suffering and died.

After that, the state was ruled by Sheikh Abbas. He delivered the lands to slaves and strictly controlled the distribution of water. In this case, he was assisted by his little brother Kechirmas bobo (Unforgiving father), who severely punished any violation of the rules. After the death of Sheikh Abbas Vali, the local people began to respect him as a saint, and many people visited his grave" [Snesarev 1983, 126].

While collecting information about the saint, G.P. Snesarev draws attention to the fact that they have different meanings. He offered this information about the origin of Sheikh Abbas Vali from an old man Nasrullah Mahsum: "Sheikh Abbas Vali was not a local, but came from Turkey. He had no father and his mother was seriously ill. One day he called his son and said to him: "I am going to die today, bury me and go to Khorezm yourself. You will be the king of a kingdom there". After burying his mother, Shabboz came to Khorezm. He ruled here for a while. Then he left them all and became a Sufi and reached the level of a great sheikh". [Snesarev 1983, 126-127].

G.P. Snesarev, relying on calculations based on conversations with informants, suggests that Sheikh Abbas Vali died in about 1188. Also interesting is the information received by G.P. Snesarev from Kuramboy Makhsum about the miraculous qualities of the saint: "Once upon a time there was a war in these places. The enemy has invaded. That's when Shabboz bobo opposed them.

He collected a pile of stones in his robe and poured them on the enemy. Shabboz bobo was a wanderer, a madman" [Snesarev 1983, 127].

The already contradictory information about the saint Shabboz bobo was further deepened on the basis of stories taken around Kat-qala (Shavat district) on the left bank of the Amu Darya.

In 1958-1960, G.P. Snesarev was collecting ethnographic data in the territory of Shavat district of Khorezm region, and thoroughly studied the left bank Kat-qala and its surroundings. "In those years, this monument stood out as a half-ruined surrounded with wall. The population had mostly moved to the surrounding villages. There were only 2-3 families living in the fortress" [Snesarev 1983, 127].

G.P. Snesarev collects information about the history and origins of the inhabitants of the left-bank Kat-qala based on the legends he heard from the locals here.

The fate of left bank Kat is closely linked to the legends of Shabboz Bobo. At the time of G.P. Snesarev's research, several legends about the relocation of the population of the ancient capital of Khorezm, Kat (Shabboz), to the new Kat on the left bank, had not yet risen from the memory of the older generation.

The issue of relocation of the population of the ancient capital Kat to new places depends on the direction of the flow of the Amu Darya and the natural disasters associated with floods. There are, of course, a number of sources, including Abu Rayhan al-Biruni's "Monuments of the Ancient Nations": Al-Fir could be seen from a distance of 10 miles or more. It was gradually washed away by Jayhun every year, and in 1305 of Alexander's history nothing was left of it" [Beruni 1968, 71].

Other information about the Amu Darya on the right bank of Kat-qala is mentioned in the account of the 17<sup>th</sup> century events of the Khivian historian Shermuhammad Munis: "During the reign of Anushakhan (1663-1683) Kat on the right bank was left without water. For this reason, he dug a new Yormish canal on the left bank of the Amu Darya, built a fortress next to it and relocated the population to this new city. This fortress was called New Kat" [Gulyamov 1959, 200].

Apparently, the flooding of Kat-Shabboz was frequently observed in both the Middle Ages and new period. G.P. Snesarev also recorded that a similar catastrophe occurred in 1902 as the old people of Shabboz [Snesarev 1983, 128].

Whenever there was a conversation about the people displaced from Kat-Shabboz, the story of the saint Shabboz bobo would always begin. The reason for the various calamities that befell the city



and its inhabitants was that they were cursed by the saint Shabboz Bobo. Myths and legends about this are so fragmented and confusing that it is very difficult to connect them.

However, their content suggests the following: “The population of Kat-Shobboz is divided into two groups: “katli” and “shotli”. It is still unknown what this division means. Apparently, the city was meant to be divided into two neighborhoods. One day, the katli people insulted the saint, that is, they burn his straw hat, and the sheikh curses them for it. According to some legends, it was these katlies who moved to the left bank. The information about this that G.P. Snesarev received from 54-year-old Jamol Khoja near Kat on the left bank is very interesting: “One of those who came here burned Sheikh Abbas Vali’s skullcap. The people of Shabboz say about us: “The one who set fire to Shabboz’s skullcap”. If someone crossed the left bank from Kat to the right bank, he was turned out” [Snesarev 1983, 128-129].

Hence, Sheikh Abbas Vali was the patron-protector of ancient Kat from the right bank. There is even a saying about him: “Sheikh Abbas in front of the work, a thousand go-heads in front of the soup”. The informant who quoted this proverb, in turn, gives information about the meaning of the name of the saint: the word “Abbas” means “water bearer, water giver”, and thus indicates that when irrigating the land, water was pumped to the high places by means of a chighir (water pumping wheel set on a river). Consequently, this informant believes that the name of the saint is widespread in Khorezm and is associated with the duties of the saints who provided people with the most important source of water [Snesarev 1983, 129].

It is very difficult to give clear evidence about the period of the life, birth and death of Sheikh Abbas Vali, the patron-protector of the Shobboz. Only information about his death is available. As noted above, he died in 1188 [Snesarev 1983, 127], according to some sources in the thirteenth century [Gulyamov 1959, 212].

At the same time, we come across another interesting source about Sheikh Abbas Vali in the pamphlet “Tazkiratul avliyo, i.e. mentions of the saints in Khorezm” written by Qamariddin Eshon Muhammad Karim Eshon oghli and Komiljon Durdi Qilich oghli:

“According to some narrations, His Highness was a relative and ally of the Sufi Imam Muhammad al-Ghazali. He was also the one who

made *sujjodanishin*<sup>1</sup> in the land of Khorezm, revealed the history of the sheikhdom and expressed mysticism to the people.

He was buried in a place called Old Kat on the north side of the river Jayhun (Amu).

It is said that he came to the area and was busy with farming. The people of that area were annoying him from time to time. He used to say, “It is sunnah for us to feel insults from our own people”, since the Sultani Anbiyo Prophet Muhammad (peace and blessings of Allaah be upon him) was also persecuted by the Quraysh people. From time to time, he held a canopy of straw and reaped plants in the heat.

One day, while He was lying on the grass in that program, He threw an umbrella of straw from his head into a fire. His heart aches. It is not because the umbrella is burning in the fire, but because of the disrespect and indifference of those who live in that area. That is why it is said that the people of the coast prayed badly for not turning their heads away from the evil path. According to legends, the date of his death is “Sahibi zamon”. – 784 AH” [Qamariddin Eshon Muhammad Karim Eshon oghli, Komiljon Durdi Qilich oghli 1997, 6-7]<sup>2</sup>.

It is clear from this date that the death of Sheikh Abbas Vali dates back to 1382 AD.

Thus, in the middle of the twentieth century, the legends about Sheikh Abbas Vali were mostly found in the monuments of the people of the right bank Kat, i.e. Shobboz, but the memories of the ancient capital are still preserved, albeit in a fragmentary form among the older representatives of the population of the left bank Kat-qala.

## CONCLUSION

The research of the Uzbek ethnographic group of the Khorezm Archaeological and Ethnographic Expedition led by G.P. Snesarev presented contradictory and interesting legends and myths of different content related to the history of the left bank Kat-qala. According to legends and myths, the fortress is associated with the character of Rustam, the hero of the epic poem “Shohname”, as well as information about the history of the

<sup>1</sup> “Sujjodanishin”, more exactly “sajjodanishin” (سجاده نشين) – “sajjoda” (سجاده) – joy namoz (praying place of muslims), “nishin” (نشين) – to sit, i.e. a man who is always praying sitting on joy namoz.

<sup>2</sup> In gathering this information, the authors note that they applied the works “Tazkiratul Avliyo” by Fariddin Attor, “Nafahot ul uns” by Abdurahmon Jomi and “Rashahoti ain al-hayot” by Fahridin Ali Voiz.



construction of most monuments, the image of the “giant” to build this fortress. Studies show that the name of the left-bank Kat-qala is directly related to the ancient Kat on the right-bank. This is reflected in the historical processes associated with the resettlement of the inhabitants of the ancient city during the reign of Anushakhan. In turn, the fact that the legends about Sheikh Abbas Vali are widespread among the townspeople on both shores also confirms the connection between them.

Although the cultural layers of the monument cover a 2,400-year historical period, the legends and myths associated with its history cover the last 300 years of the city. The question of its ancient name has not yet been sufficiently studied. Life at the monument ceased completely after the Mongol invasion and was abandoned until the time of Anushakhan (1664-1686). Apparently, the area around the monument was also in a state of disrepair for a long time. The people who migrated from the ancient Kat on the right bank of the Amu Darya also bring here their memories, mainly related to their ancient cities. Although this information is related to the later period of the monument, it is of great importance as a source that serves to fully cover the period of the fortress’s history of the 17<sup>th</sup>-19<sup>th</sup> centuries.

## REFERENCES

1. Аржанцева И.Н. 2016. Хорезм история открытий и исследований. Этнографический альбом (Arzhanceva I.N. 2016. *Khorezm, history of opening and researches. An ethnographic album*). – Ulyanovsk: publishing house ООО “Артишок”.
2. Veruni Abu Rayhan. 1968. “Monuments Left from Ancient People” // *Selected works. Volume I*. – Tashkent: publishing house “FAN” Uz SSR.
3. Гудкова А.В. 1964. Ток-кала (Gudkova A.V. *Toq-qala*). – Tashkent: “Наука”.
4. Фуломов Я.Ф. 1959. Хоразмнинг сузориши тарихи (Gulyatov Y.Gh. *Irrigation History of Khorezm*). – Tashkent: Academy of Sciences of UzSSR.
5. Қамариддин Эшон Муҳаммад Карим Эшон ўгли, Комилжон Дурди Қилич ўгли. 1997. “Тазкиратул авлиё, ёҳуд Хоразм диёрида мадфун бўлган авлиёлар зикри” (Qamariddin Eshon Muhammad Karim Eshon ogli, Komiljon Durdi Qilich ogli. *Tazkiratul avliyo, i.e. mentions of the saints in Khorezm*). – Khonqa: Publishing house of Khonqa district.
6. Снесарев Г.П. 1969. Реликты домусульманских верований и обрядов у узбеков Хорезма (Snesarev G.P. *Relicts of beliefs before Muslims and ceremonies of the Uzbeks of Khorezm*). – Moscow: “Наука”.
7. Снесарев Г.П. 1983. Хорезмские легенды как источник по истории религиозных культов Средней Азии (Snesarev G.P. *The Khorezm Legends as a Source on History of Religious Cults of Central Asia*). – Moscow: “Наука”.
8. Толстов С.П., Жданко Т.А., Итина М.А. 1963. Работы Хорезмской археолого-этнографической экспедиции АН СССР в 1958 – 1960 гг. (Tolstov S.P., Jdanko T.A., Itrina M.A. *Works of Khorezm archeologo-ethnographic expedition of the Academy of Sciences of the USSR during 1958-1960*) – МХЭ, 6<sup>th</sup> edition. – Moscow: Publishing house of the Academy of Sciences of the USSR.
9. Ходжаниёзов Ф. 2007. Қадимги Хоразм мудофаа иншоотлари (Khojaniyozov Gh. *The military architecture of ancient Chorasmia*). – Tashkent: “O’zbekiston”.



## **A STUDY ABOUT PADDY FARMER PRODUCER COMPANIES IN KUTTANAD (2016-2019)**

**Aby George**

*Research Associate, International Centre for Technological Innovations, Alappuzha, Kerala*

### **ABSTRACT**

*Paddy is one of the main crop cultivated in Kuttanad. Kuttanad is the only place where paddy farming is done below sea level. Most of the people in Kuttanad depend on agriculture for their livelihood. Some farmers are falling apart from paddy farming due to the difficulties in it. Farmer Producer Organization (FPO) is typically a society/company consisting of only practicing farmers who are also actual producers of a specified commodity/commodities, and is formed under the Companies Act. There are 131 FPOs in Kerala and out of these only 2 FPOs are currently providing services to paddy farmers in Kuttanad.*

*The aim of the study was to find out which are the FPOs that are working for Kuttanad paddy farmers and to learn what the problems are facing by paddy farmers of Kuttanad. In addition to this to give some recommendations to other FPOs in Kerala to support the paddy farmers in Kuttanad. Additionally a financial analysis of FPOs working for Kuttanad paddy farmers were also done. The research made use of primary data obtained from paddy farmers in Kuttanad through direct interview. To know more about the problems faced by paddy farmers a questionnaire was prepared before the interview. Secondary data was obtained from the website of Ministry of corporate Affairs, Government of India.*

*From the study conducted it became clear that FPOs plays an important role in supporting paddy farmers. Currently Farmertree Producer Company limited and Kuttanad Agro Producer Company limited are working for paddy farmers in Kuttanad. More FPOs should come forward to support paddy farmers with the services like insurance, input supply, financial Services, procurement and packaging, technical services and networking.*

**KEYWORDS:** FPO, Paddy, Kuttanad, Agriculture, Farmers

### **CHAPTER - 1**

#### **INTRODUCTION**

##### **1.1 Kuttanad: Below Sea Level Farming System**

Kuttanad, the 'Rice Bowl of Kerala', lies in the very heart of the Alappuzha district backwaters. What got this unique nickname is its wealth of paddy crops. Based in the inner regions of the district, it is a huge area of reclaimed land, separated by dikes from water which is higher than it appears. The countryside view is what enchants all those who pass through this area as they travel through houseboats. It has been speculated that it is perhaps the only place in the world where farming is done up to 2 meters below sea level. Four major rivers serve the area: Pampa, Meenachil, Achankovil, and Manimala. (Department of Tourism, Kerala)

The soil in Kuttanad is a varied combination of sand and clay. Generally the soil is highly acidic in

most of the low lying areas, and contains salts. Depending on the type of soil the entire wetland area of the region can be classified into kayal lands, karappadams and kari lands. Reclaimed Kayal lands Vembanad lake beds and are located mainly in Kuttanad and Kottayam taluks. As puncha crop (summer crop) is the traditional crop in Kuttanad during which 80% of the paddy fields are sown, from early days paddy cultivation in this region is called puncha cropping. The season begins from October-November when the process starts to bail out water from padasekharams. The other season is the virippu season (autumn or varsha crop) where 40 per cent of paddy land is grown. For most of the year, padasekharams where the second crop is not elevated are submerged under water. (Thomas, 2002)

Large agricultural areas near Lake Vembanad were in fact reclaimed from the lake. Following the Land Reclamation Act (1949), which decreed that





land can be owned by anyone who reclaims land from water, many enterprising farmers took up the challenge leading to massive land redemption from the lake. As farming in the area rose, because of the limited availability of potable water in Kuttanad, farmers restricted rice cultivation to two cycles a year. The water from the mountains flows through the rivers into the sea during the monsoon seasons, bringing potable water to Kuttanad.

## 1.2 Agriculture in Kuttanad

According to FAO, Kuttanad Wetland Agriculture System is unique, as it is India's only system that favours rice cultivation below sea level in the soil created by draining delta swamps in brackish waters. As an approach to coping with the impending climate impacts in coastal areas and evolving efficient methods, it aims to address the availability of soil and overflows problems in agriculture. The Kuttanad system is a complex mosaic of fragmented agricultural landscapes divided into three structures: wetlands used for paddy and fish catching activities, garden lands used for coconut, tubers and grown food crops, and water areas used as inland fishing and shells. Wetlands were formed by the construction and dewatering of polders with bonds. Faced with extreme water contamination due to tourism but also the use of chemicals, it is necessary and urgent for humanity to protect this fragile and unique environment from any external pressure, as it is crucial for the conservation and enhancement of so much ecological biodiversity and other critical ecosystem services for human well-being worldwide.

In addition to this duck farming, livestock and banana cultivation are also being taking part in the lands of Kuttanad. However paddy farming is the main among the other types of cultivation and the income from paddy farming is the main source of income for the 75% of people living in Kuttanad.

There are about 150,000 farmers in Kuttanad who cultivate paddy. Rough estimates by state government officials put the rice production in 2019 pancha season at two lakh tonnes – 75,000 tonnes higher than the previous year's harvest. Farmers in lower Kuttanad, which is prone to moderate flooding, got the highest yield as compared to upper Kuttanad (which lies closer to the uplands), kayal lands (in the vicinity of the Vembanad Lake), north Kuttanad (the deltaic formation of the Meenachil river), Kari lands (which come under the west southern side and the northern side of the deltaic formation) and Purakkad (which lies at the western side of upper Kuttanad). (Ameerudheen, 2019)

## 1.3 Farmer Producer Organisations (FPO)

Considering the judicial environment and the agrarian sector's political sensitivity, there is a

gradual recognition that one of the ways to overcome the many challenges faced by Kuttanad farmers is through voluntary collectivization of farmers into producer organizations (POs). Producer organizations are argued as the only institution that can protect small farmers from the adverse effects of globalization or make them successfully participate in modern competitive markets (Trebbin and Hassler, 2012). This is being projected as a 'solution from below' to address the challenges faced by small and marginal farmers. Indian government does not force farmers to join POs by passing laws and policies, but organizes various awareness programs across India to promote producer organizations and farmers' benefits.

A Producer Organization (PO) is a legal entity made up of primary producers, including farmers, dairy producers, fishermen, weavers, rural craftsmen, and artisans. A PO can be a producer corporation, a cooperative society, or some other legal structure that allows for profit / benefit sharing between members. Farmers' Organization (FPO) is one form of farmers' organization where the members are farmers. Thus the farmers' reliance on intermediaries can be reduced by collectivizing farmers into FPOs and allowing farmers to access better markets. Several initiatives have been taken by the government, top financial institutions such as the National Bank for Agricultural and Rural Development (NABARD), private donor organisations, financial institutions and many other institutions to support and nurture the development of FPOs and to facilitate their emergence as efficient profit-making enterprises. (Nicku, 2017)

## 1.4 Objectives

The main objective of this research is to:

1. Explore FPOs providing services to farmers in Kuttanad.
2. Conduct interviews with farmers and identify their difficulties.
3. Analyse the performance of existing FPOs based on financial statements and membership.
4. Give recommendations and provide FPOs better understanding about services required by farmers in Kuttanad.

## CHAPTER. 2

### MATERIALS & METHODS

#### 2.1 Methods

The results and data presented in this research paper were part of a study on FPOs that are working for paddy farmers in Kuttanad. As mentioned in the introductory chapter the main objectives of the research is to identify the difficulties of paddy





farmers, and to explore FPOs providing services to farmers in Kuttanad. Additionally, to review the FPOs results based on the basis of financial statements and membership and to offer recommendations and provide FPOs a better understanding of the services farmers required in Kuttanad. To achieve these quantitative research method was carried out. Quantitative research focused on data collection of different FPOs which are offering services to farmers in Kuttanad. Along with this direct interview was also conducted with farmers in Kuttanad. The data about FPOs were collected by downloading the annual returns and financial statements from the website of Ministry of Corporate Affairs, Govt. of India. A number of services needed for farmers were found out and a list of required services for farmers in Kuttanad were created.

## 2.2 Sample Group

In the research conducted the sample groups were FPOs that are offering services to the paddy farmers in Kuttanad and the 50 farmers in Kuttanad region. There are only two FPOs that were giving services to farmers in Kuttanad which are Farmertree Producer Company Limited and Kuttanad Agro Producer Company Limited. Only those FPOs providing services to paddy farmers in Kuttanad were selected for this research. Also, these FPOs were supported by National Bank for Agriculture and Rural development (NABARD) and Small Farmers Agribusiness Consortium (SFAC).

## 2.3 Interview

The interview questions were prepared before the farmers were selected for the direct interview and were centred with the objectives outlined in chapter 1. The interview consisted of 6 questions, out of which 5 questions were mandatory. All the 6 questions were simple and farmers can easily answer all the questions. The interview for the farmers were conducted on 7<sup>th</sup> and 8<sup>th</sup> days of July 2020. On 7<sup>th</sup> July the interview was for paddy farmers in Kainakary village and the interview was started almost by 10 am. On that day 25 paddy farmers were interviewed and 20 paddy farmers participated actively. By 5 pm the interview was finished. On the following day (8<sup>th</sup> July) the interview was conducted for paddy farmers in Chempumpuram from 9.30 am to 3 pm. In Chempumpuram 25 paddy farmers were interviewed and 22 farmers participated in the interview actively.

## 2.4 Secondary data analysis

The data of FPOs were collected from the website of Ministry of Corporate Affairs (MCA), Government of India and also from the website of the

companies. The data includes the financial statements of the FPOs that were giving support to paddy farmers in Kuttanad region. Some of the data of FPOs were also collected from the officials of NABCONS, NABARD. MCA regulates corporate affairs in India through the Companies Act, 1956, 2013 and other allied Acts, Bills and Rules.

## CHAPTER 3 RESULTS AND DISCUSSION

### 3.1 Introduction

This chapter discusses the problems faced by the paddy farmers in Kuttanad, details about the FPOs that were working for Kuttanad paddy farmers, services provided by these FPOs and an analysis of performance of these FPOs. From the study conducted there were only two FPOs that were working for paddy farmers in Kuttanad region. The details of study were as follows:

### 3.2 Problems faced by paddy farmers of Kuttanad

Paddy farmers in Kuttanad are facing a lot of difficulties. They are as follows:

#### 3.2.1 Ecological Problem

The survey identified a factor which were contributed to the ecological problem of Kuttanad was flood. When interviewed on 8 July 2020, Mrs Mariamma Thomas (a farmer in Kainakary) stated that severe flood affect this cultivable land of Kuttanad during the south west monsoon season (June - August) by discharge of the four major rivers Manimala, Meenachil, Pampa and Achankovil. When interviewed on 7 July 2020, Mr Alexander J stated that farmers are afraid to do paddy cultivation during this time of monsoon and some of the farmers are giving their farms for lease to interested farmers due to the fear of flood.

When interviewed on 8 July 2020, Mr Hariharan Nair (a farmer in Chempumpuram) stated that due to heavy use of pesticides and chemical fertilizers the water in the lakes were getting polluted. People in Kuttanad are prone to cancer due to excessive use of pesticides and chemical fertilizers.

#### 3.2.2 THE PROBLEM OF LABOUR SHORTAGE

Mr Ouseph Thomas (a farmer in Kainakary) was interviewed on 7<sup>th</sup> July 2020 as a part of this study. He mentioned paddy cultivation from farm preparation to harvesting takes about 140 days. To cultivate an acre of land in Kuttanad requires about 35 labour days. There is a severe shortage of farm labourers in this area. The new generation of



Kuttanad are educated and most of them are attracted by technical and white-collar jobs nationally and internationally. The non-remunerative nature of paddy cultivation makes it less attractive both for the farmers and farm labourers. The peculiar nature of Kuttanad land demands specialized mechanization conducive to the land texture and climatic conditions. Failure to adopt proper mechanization increased the labour shortage problem.

### **3.2.3 UNDER DEVELOPED INFRASTRUCTURE**

Under developed infrastructure is one of the main problems that are facing by the paddy farmers in Kuttanad. When interviewed on 7 July 2020, Mr Gopi Erumeli (a farmer in Chempumpuram) stated that lack of proper farm roads, increased the manual labour and denied mechanization. Heavy machines are not suitable for the soil of Kuttanad. Lack of proper canal and buds are allowing the salt intrusion to the paddy field that was badly affected the cultivation. Manual labour was consuming so much money and time of farmers. There is no modern rice mill in Kuttanad and there is also a shortage of warehousing facilities.

### **3.2.4 PADDY PROCUREMENT & PAYMENT**

The Kerala state government has entrusted the Kerala State Civil Supplies Corporation Ltd (popularly non as Supplyco) with the responsibility of procuring paddy from the farmers of Kerala, mainly in the rice producing regions which includes Kuttanad. When interviewed on 7th July 2020, Mr George Joseph (a farmer in Chempumpuram) stated that paddy farmers in Kuttanad need to wait for 3-4 days after harvesting for procurement. During the monsoon seasons, due to lack of drying facilities procuring mills will deduct up to 10% of the produce from farmers. This is a huge burden to paddy farmers in Kuttanad. The mill agents are making huge profit through these deductions and farmers are not getting any benefits.

The farmers have to go through complicated formalities to sell paddy and the payment is always inordinately delayed. Farmers are struggling to make their livelihood because of the delayed payment. They need to take loans and credits to make their livelihood.

### **3.2.5 Other Factors**

When interviewed on 8 July 2020, Mrs Shobha Panicker (a farmer in Chempumpuram) stated that unwieldy size of some padasekharams which amounts to more than 1000 hectares, high acidity of soil, ingress of saline water, high incidence of pests like brown plant hopper, leaf roller, case worm, stem borer, rice bug etc., plant diseases such as sheath blight, blast, sheath rot and stack burn and growing menace of weeds like salvinia, grasses, sedges etc., also adversely affect the per hectare productivity and thereby the profitability of paddy cultivation in Kuttanad region.

### **3.3 Details & Services of FPO's working for Kuttanad paddy farmers**

Currently there are 131 FPOs in Kerala. But only two FPOs are presently working for paddy farmers in Kuttanad region. They are Farmertree Producer Company Limited and Kuttanad Agro Producer Company Limited. Both of these FPOs are located in Alappuzha.

#### **Case study 1: Farmertree Producer Company Limited**

Farmertree was established in 2015 by a collective of paddy farmers from Kuttanad region in the state of Kerala, India. The farmer producer company is a spinout of the International Centre for Technological Innovations, initially sponsored by the National Bank for Agriculture and Rural Development under Producers' Organization Development and Upliftment Corpus' Fund (PRODUCE) Scheme. The company now collectivizes producers in several agriculture sectors, especially small and marginal farmers, to address the many challenges of agriculture but most importantly, improved access to investments, technology, inputs and markets (farmertree.com).

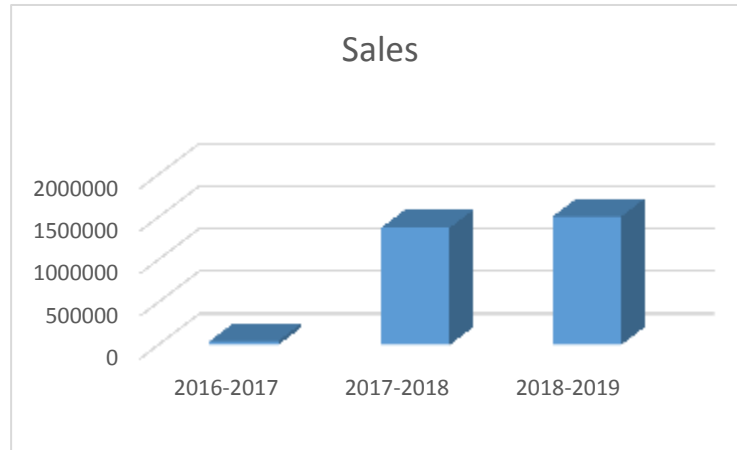
The 5 Directors of the FPC are George Joseph, Grace Joseph Mampallil, Aaron Joseph George, Josekutty Antony and Jessy Joji. There are 910 member farmers for this FPC. Paid up share capital of the company is Rs. 10, 00,000.

The main activity of FPC is sale of paddy seeds to the paddy farmers in Kuttanad. In the last financial year paddy seeds were sold to about 2500 farmers in Kuttanad and the revenue was Rs. 1507435. In addition to this FPC also engaged in processing and marketing of agricultural products like rice powder.



**Table 3.3.1 Sales table of Farmertree FPC**

YEAR	Sales( in Rs)
2016-2017	44902
2017-2018	1375220
2018-2019	1507435



**Figure 3.3.1 Sales in the last 3 financial years**

**Case study 2: Kuttanad Agro Producer Company Limited**

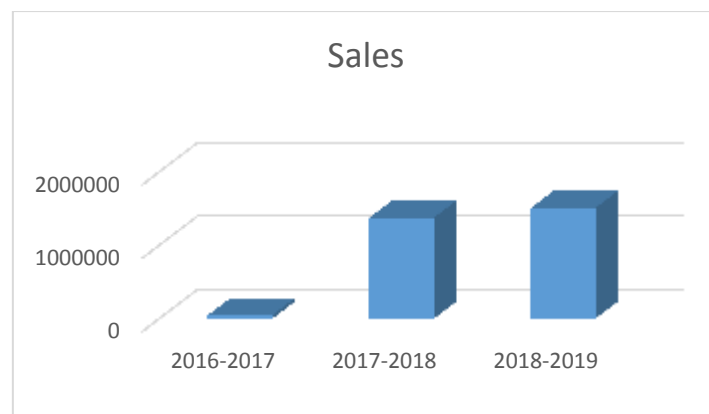
Kuttanad Agro Producer Company was incorporated on 24 February 2016. The Kuttanad Agro Producer Company Limited is funded by National Bank for Agriculture and Rural Development (NABARD) under Producers’ Organization Development and Upliftment Corpus’ Fund (PRODUCE) Scheme. The promoting institution of Kuttanad Agro Producer Company is

Force for Rural Empowerment and Economic Development (FREED).

The 5 directors of the FPC are Pandialakkal Joseph Mathew, JishaShaji, Mini, Shyla and Lethika Sunilkumar. There are 394 members in this FPC. Its paid up capital is Rs. 394,000. The main activity of the FPC is sale of rice powder. In the last financial year the sales of FPC was Rs 8, 20,674

**Table 3.2 Sales table of Kuttanad Agro FPC**

YEAR	Sales ( in Rs)
2016-2017	427041
2017-2018	577742
2018-2019	820674



**Figure 3.3.2 Sales in the last 3 financial years**



### 3.4 Performance analysis of FPO's working for Kuttanad farmers

Both FPOs are working actively for paddy farmers in Kuttanad. Farmertree FPO mainly focuses on the sale of paddy seeds and Kuttanad Agro FPO mainly focuses on Sale of rice powder. The

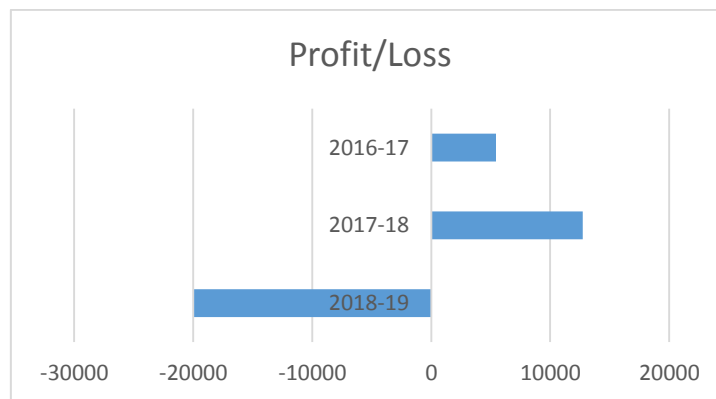
performance of both companies in the last 3 financial years are plotted below in the graphs.

The Profit/Loss graph of each companies are illustrated below:

#### Performance of Kuttanad Agro Producer Company Limited Profit/Loss

**Table 3.4.1 Profit/Loss table of Kuttanad Agro FPC**

YEAR	Profit/Loss( in Rs)
2016-2017	5454
2017-2018	12741
2018-2019	-19910



**Figure 3.4.1 Profit/Loss Graph of Kuttanad Agro FPC**

In the financial year 2018-2019 Kuttanad Agro Producer Company was in loss of Rs 19910 and in

the financial years 2017-18, 2016-17 the company was in a profit of Rs 12741 and Rs 5454 respectively.

#### MEMBERSHIP Growth

YEAR	No. of Members
2016-17	247
2017-18	345
2018-19	394

**Table 3.4.2 Members Table of Kuttanad Agro FPC**

The members amounted to 247,345 and 394 in the financial years 2016-17, 2017-18 and 2018-19.

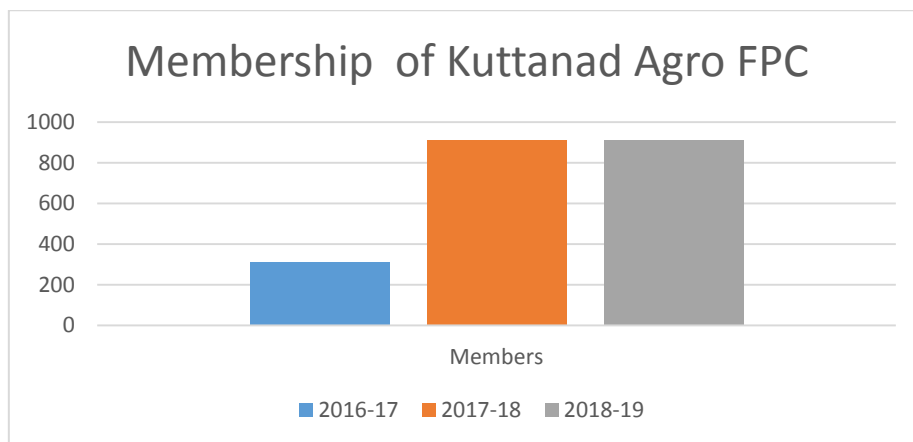


Figure 3.4.2 Members Graph of Kuttanad Agro FPC

**Performance of Farmertree Producer Company Limited**

Table 3.4.3 Profit/Loss table of Farmertree FPC

YEAR	Profit/Loss( in Rs)
2016-17	-50842
2017-18	20100
2018-19	20000

The Farmertree FPC was in a loss of Rs 50842 in the financial year 2016-17. But in the financial years 2017-18, 2018-19 the company was in a profit of Rs 20100 and Rs 20000.

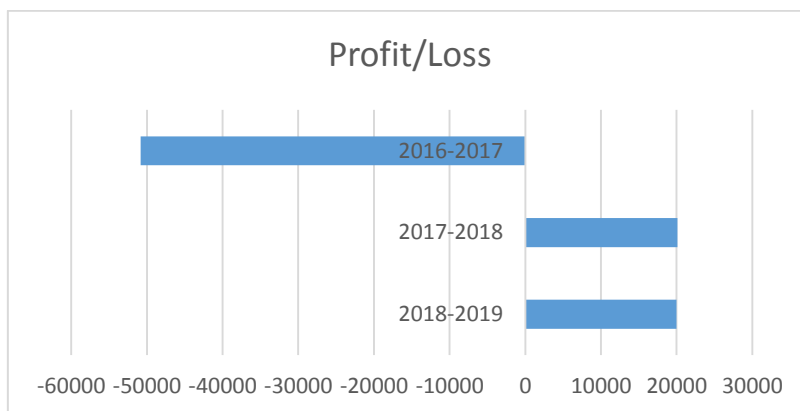


Figure 3.4.3 Profit/Loss Graph of Farmertree FPC

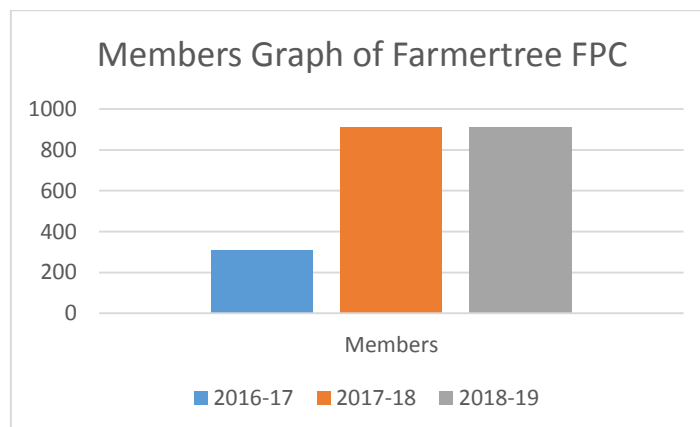
**MEMBERS GROWTH**

YEAR	No. of Members
2016-17	350
2017-18	910
2018-19	910

Table 3.4.4 Members table of Farmertree FPC

The membership was 350 in the financial year 2016-17 and 910 members were there in the financial years 2017-18 and 2018-19.



**Figure 3.4.4 Members Graph of Farmertree FPC**

## CHAPTER-4 CONCLUSION & ACKNOWLEDGEMENT

To put it in a nutshell, this study mainly focused on finding out which are the FPOs working for Kuttanad paddy farmers and problems of paddy farmers in Kuttanad region. The chapter 1 figure out about the details of Kuttanad and agriculture methods in Kuttanad. Chapter 2 explains the method of interview that was conducted for this study and the source of data collected for the study. Chapter 3 comprises the outcome of the study.

In my opinion the FPOs in Kuttanad region should come forward to provide following support to paddy farmers in Kuttanad.

1. **Financial Services:** The FPOs should provide loans for crops, purchase of tractors, pump sets, construction of wells, laying of pipelines.
2. **Input Supply Services:** The FPOs should provide low cost and high quality inputs to paddy farmers. It will supply fertilizers, pesticides, seeds, sprayers, pump sets, accessories and pipelines.
3. **Procurement and Packaging Services:** The FPOs should procure agriculture produce from the paddy farmers in Kuttanad; do the storage, value addition and packaging.
4. **Marketing Services:** The FPOs should do the direct marketing after procurement of agricultural produce. This will enable paddy farmers to save in terms of time, transaction costs, weight loss, distress sales, price fluctuations, transportation, quality maintenance etc.
5. **Insurance Services:** The FPOs should provide various insurance like Crop

Insurance, Electric Motors Insurance and Life Insurance to paddy farmers in Kuttanad.

6. **Technical Services:** FPO should promote best practices of farming, maintain marketing information system, diversifying and raising levels of knowledge and skills in agricultural production and post-harvest processing that adds value to products.
7. **Networking Services:** FPOs should make channels of information (e.g. about product specifications, market prices) and other business services accessible to rural producers; facilitating linkages with financial institutions, building linkages of producers, processors, traders and consumers, facilitating linkages with government programmes to paddy farmers in Kuttanad.

### Interview questions for farmers

1. How many acres of land have you cultivate paddy?
2. Have you been doing the paddy farming in own farm or for lease?
3. Have you took an insurance for your paddy farming?
4. What about your paddy farming is it profit/loss?
5. Please tell me about the paddy procurement and payment of sold paddy?
6. What are your present problems in paddy farming?

### REFERENCES

1. *Kerala Tourism Development(KTD), Government of Kerala, viewed on 5 July 2020 from <https://www.keralatourism.org/kerala-article/2013/heritage-status-kuttanad/455>*
2. *Food & Agriculture organisation of United Nations (FAO), viewed on 5 July 2020 from <http://www.fao.org/giahs/giahsaroundtheworld/d>*



*esignated-sites/asia-and-the-pacific/kuttanad-below-sea-level-farming-system/en/*

3. Ameerudheen TA 2020, 'The acer laptop is here' Nine months after floods devastated Kerala, paddy farmers in Kuttanad reap bumper harvest, viewed on 5 July 2020, from <https://scroll.in/article/917638/nine-months-after-floods-devastated-kerala-paddy-farmers-in-kuttanad-reap-bumper-harvest>.
4. Trebbin, A. and Hassler, M. (2012), 'Farmers producer companies in India: a new concept for collective action?' *Environment and Planning A*, 44, pp. 411-427.
5. Farmertree.com n.d., Farmertree Producer Company limited, viewed 4 July 2020, from <https://www.farmertree.com/about.html>.
6. Nicku Abraham Mathew, 2017 'The role of farmer producer organisations (fpos) in achieving sustainable agricultural development of India and a list of institutions providing financial assistance in different stages of fpo life cycle', Msc Thesis, Queens University Belfast.
7. P M Thomas, 2002 'problems and prospects of paddy cultivation in kuttanad region a case study of ramankari village in kuttanad taluk' Draft Report

## GLOSSARY

**Farmer Producer Organisation-** It is one type of PO where the members are farmers. A Farmer Producer Organization (FPO) is typically a society/company consisting of only practicing farmers who are also actual producers of a specified commodity/ commodities, and is formed under the Companies Act.

**National Bank for Agricultural and Rural Development-** is an apex development financial institution in India, headquartered at Mumbai with branches all over India. The Bank has been entrusted with matters concerning policy, planning and operations in the field of credit for agriculture and other economic activities in rural areas in India.

**Small Farmers' Agribusiness Consortium-SFAC** is an exclusive Society focused on increasing incomes of small and marginal farmers through aggregation and development of agribusiness.

**The Food and Agriculture Organization of the United Nations** - is a specialized agency of the United Nations that leads international efforts to defeat hunger and improve nutrition and food security.



# MICRO FINANCE AS A TOOL FOR ERADICATION OF POVERTY

**Pallavi Sarma**

*Guest Lecturer, Department of Economics, Rangia College, Assam, India*

## ABSTRACT

India has travelled a long distance on the road to development since independence and has made significance progress in various sectors. The development in rural areas, however, has not kept pace with the overall progress in other facets of national life. Even today, nearly one third of the rural poor subsist in poverty and there remains an acute shortage of basic facilities like housing, drinking water, road in rural areas. To correct the imbalance, remedial steps have been taken in the last few years to bring rural development in the forefront of national reconstruction. In this case, the concept of Micro Finance was introduced for overcoming the existing constraints and providing adequate credit to the poor in the rural areas. Micro Finance is the provision that provides access to various financial services such as credit, saving, micro-insurance, remittances, leasing to low-income clients. Micro Finance becomes a buzzword in the credit markets as an effective tool for poverty reduction and socio-economic development. It is a broad category of services, which include micro credit. Micro credit is one of the aspect of micro finance and the two are often confused the micro finance revolution in India as a powerful tool for poverty alleviation. In this paper, an attempt has been taken to study the impact of micro finance on the low income people. Based on the findings we consider micro finance as an effective tool for breaking the vicious circle of poverty. Moreover, it also studies the schemes of govt. of India and the salient features of micro finance programme of govt. of India.

**KEY WORDS:** Development, poverty, microfinance, microcredit, vicious circle of poverty.

## 1. INTRODUCTION

The topic of micro finance has been receiving increased attention and has become a centre of discussion among experts in recent decades. Micro Finance is often presented as a panacea for poverty alleviation, particularly in developing countries.

According to Robinson (2001), poverty in developing countries is associated with low economic development, high population growth, unequal distribution of resources, wide-spread diseases, etc. This results in low productivity as well as unemployment of the poor.

According to Bassem (2012), micro finance is a response to the debt problems and economic crisis in most developing countries. In the sense, it is seen as one of the tools intended to reduce poverty.

Micro finance can help low income individuals start running their own business and build assets, reduce risk, raise productivity, obtain higher returns on investments, increase their incomes and, above all, improve the quality of their lives. The fact that financial services are available to anybody can be

considered the biggest benefit of microfinance institutions (MFIs) to the poor. Providing small loans, so-called microcredit, is generally considered as the basis of microfinance services. Micro finance providers also offer social and technical services. Examples includes group formation, the development of self-confidence, training in financial literacy and management, and other non-financial services related to enterprise development, such as skill training and marketing as well as social services, such as literacy training, health care, etc. Thus the definition of microfinance should include both financial intermediation and social intermediation. Generally, microfinance is not simply banking; it is a development tool.

## 2. OBJECTIVES

The main objectives of this paper are-

- To analyse the role of micro-finance institutions.
- To study the micro-finance and poverty reduction in India.



- To study few schemes taken by the Govt. of India.

### 3. METHODOLOGY

This paper is basically descriptive and analytical in nature. In this paper, an attempt has been taken to analyse the role of micro finance in reducing poverty in India. Data and information for the study are collected and analysed from secondary sources like newspaper, books, web sites, etc.

## 4. FINDINGS AND DISCUSSIONS

### 4.1 Micro Finance

Microfinance is termed as the financial services rendered to the deprived groups of the people and small entrepreneurs in savings, credit, remittance, micro-insurance etc. to help them in developing self-employment opportunities and various income generating activities.

### 4.2 History of Micro Finance

In the late 1970's, returning from U.S. where Yunus obtained his Ph.D in economics, Yunus started an organisation called Grameen Bank. Back in his hometown in Bangladesh, Yunus saw the extreme poverty in the country. Yunus was angry with the formal institutions (e.g. the World Bank, commercial banks) who had failed to help his fellow citizens. Yunus believed that formal institutions "pronounced a death sentence on the poor" because they "rejected the poor as unworthy of credit", imposing a "financial apartheid". Yunus decides he would help the poor by stepping outside of the formal institutions and providing small loans without collateral to groups of 5 borrowers; this became known as the Classical Grameen model. One village bank 1 (of several groups of borrowers) grew to two, and two grew to three, until Grameen Bank became one of the largest microfinance organisations in the world. Yunus classical Grameen model came to be known as "Micro Finance".

### 4.3 Role of Micro finance institution

#### a. Poverty reduction tool

Microfinance can be a critical element of an effective poverty reduction strategy. Improved access and efficient provision of savings, credit and insurance facilities in particular can enable the poor to smooth their consumption, manage their risks better, build their assets gradually, and develop their microenterprise. Microfinance is only a means and not an end. The ultimate goal is to reduce poverty. Government, NGOs and

other financial institutions have introduced various welfare schemes and activities to reduce poverty. Microfinance, by providing small loans and savings facilities to those who are excluded from commercial financial services has been developed as a key strategy for reducing poverty throughout the world.

#### b. Women Empowerment

In rural areas, women living below the poverty line are unable to realize their potential. Microfinance programmes are currently being promoted as a key strategy for simultaneously addressing both poverty alleviation and women's empowerment. The self help groups (SHGs) of women as source of microfinance have helped them to take part in development activities. The participation of women in SHGs made a significant impact on their empowerment both in social and economic aspects. Vast sections of the rural poor are even now deprived of the basic amenities, opportunities and oppressed by social customs and practices. Several programmes were implemented by various governments and NGOs to uplift them both economically and socially. It has been an accepted promise that women were not given enough opportunities to involve themselves in the decision making process of the family as well as in the society. Hence, women were the main target groups under SHG programmes. Microfinance can provide an effective way to assist and empower poor women, who make up a significant proportion of the poor and suffer disproportionately from poverty.

#### c. Development of the overall financial system

Without permanent access to institutional microfinance, most poor households continue to rely on meagre self-finance or informal sources of microfinance, which limits their ability to actively participate in and benefit from the development opportunities. Microfinance can contribute to the overall financial system through integration of financial markets. Microfinance institutions (MFIs) can be small and medium enterprises at the heart of rural sustainable development. Their development positively correlates with rural business development.

#### d. Self employment

Poverty reduction through self employment has long been a high priority



for the Government of India. Microfinance is an experimental tool in its overall strategies. Most of poor people manage to optimize resources over a time to develop their enterprises. Financial services could enable the poor to leverage their initiatives, accelerating the process of generating incomes, assets and economic security. However, conventional finance institutions seldom lend down-market to serve the needs of low-income families and women-headed households. Therefore, fundamental approach is to create the self employment by financing the rural poor through financial institutions. Microfinance, thus, creates the hope and increase the self-esteem of the poor by giving the opportunities to be employed.

**e. SHG-bank linkage programme**

Indian microfinance is dominated by the operational approach Self-help Groups (SHGs). The approach is popularly known as SHG-Bank linkage model. This model is the dominant model, initiated by the NABARD in the early 1990s. Today, the SHG model also links the informal groups of women to the mainstream system and it has the largest outreach to micro financial clients in the world. SHGs comprise a group of 15-20 members. The groups begin by saving that is placed in a common fund. In a way, SHGs are co-operative (credit) societies linked to a commercial bank rather than an apex cooperative bank; the SHGs may access a given multiple of the pooled savings for disbursement to its members. The SHG-bank linkage programme was conceived with the objectives of supplementary credit delivery services for the unreached poor, building mutual trust and confidence between the bankers and the poor and encouraging banking activity both on thrift as well as credit and sustaining a simple and formal mechanism of banking with the poor. The linkage programme combines the flexibility, sensitivity and responsiveness of the informal credit system with the technical and administrative capabilities and financial resources of the formal financial sector which rely heavily on collective strength of the poor, closeness of effective social mobilization functions contributing to an overall empowerment process.

**4.4 Micro Finance and Poverty Reduction in India**

Microfinance is the provision of financial services to low-income clients, including consumers and the self-employed, who traditionally lack access to banking and related services. More broadly, it is a movement whose object is “a world in which as many poor and near poor households as possible have permanent access to an appropriate range of high quality financial services, including not just credit but also savings, insurance and fund transfer”. Those who promote microfinance generally believe that such access will help poor people out of poverty. The dynamic growth of the microfinance industry has been promoted not only by market forces but also by conscious actions of national governments, NGOs and the donors who view microfinance as an effective tool for eradicating poverty. The powerful push behind this huge and increasing support for microfinance indicated that national economic and social impacts are significant and it needs to be examined more closely.

**Sustainable Micro Finance- features and principles**

Microfinance is considered to be an adequate tool for financing small scale activities/technological applications in the rural areas because of the following features.

- a) Provide credit for investment in small scale activities chosen by the poor people.
- b) Empower the poor to build self-confidence that they can do something.
- c) Can pay for itself with the interest earned.
- d) Allow to develop opportunities for self-employment to the underserved people.
- e) Have the broadest utility and the least cost per beneficiary.

The principles of sustainable micro-financing are as follow:

- i. It offers flexible customer friendly services preferred by low income group.
- ii. It has opportunities for streamlining operations and reducing costs (standardized simple lending process, decentralized loan approval, inexpensive offices and use staff from local communities)
- iii. It operates in market basis charging market interest rates and fees, and
- iv. It serves to recover the costs of the loan.





### **Role of Micro-Finance in Poverty Reduction:**

Microfinance is about providing financial services to the poor who are not served by the conventional formal financial institutions- it is about extending the frontiers of financial service provision. The provision of such financial services requires innovative delivery channels and methodologies. The needs for financial services that allow people to both take advantage of opportunities and better management of their resources. Microfinance can be one effective tool amongst many for poverty alleviation. However, it should be used with caution- despite recent claims, the equation between microfinance and poverty alleviation is not straightforward, because poverty is a complex phenomenon and many constraints that the poor in general have to cope with. We need to understand when and in what form microfinance is appropriate for the poorest; the delivery channel, methodology and products offered are all inter-linked and in turn affect the prospect and promise of poverty alleviation.

Access to formal banking services is difficult for the poor. The main problem the poor have to take when trying to acquire loans from formal financial institutions is the demand for collateral asked by these institutions. In addition, the process of acquiring a loan entails many bureaucratic procedures, which lead to extra transaction costs for the poor. Formal financial institutions are not motivated to lend money to them. In general, formal financial institutions show a preference for urban over rural sectors, large-scale over small scale transactions, and non-agricultural loans. Formal financial institutions have little incentives to lend to the rural poor for the following reasons.

#### **Administrative difficulties**

Small rural farmers often live geographically scattered, in areas with poor communication facilities, making loan administration difficult.

#### **Systematic risks**

Agricultural production is associated with some systematic risks, such as drought and floods, which is reflected in a high covariance of local incomes.

#### **Lack of information**

The absence of standardized information, standard lending tools such as financial statements or credit histories, does not exist in these areas.

#### **Repayment problems**

The repayment of working capital may be required only once a year for example during the harvest season. On the other hand, access to informal loans is relatively easy, convenient and available locally to low income households for the following reasons.

- Informal moneylenders use interlinked credit contract to reduce default risk such as

development of business relationship with the clients.

- Informal moneylenders have local information which helps them to appraise credit needs and credit worthiness of the client.
- Informal moneylenders are considering the needs and requirements of clients even for small amounts of loan.
- Informal moneylenders will profit from social sanctions such as those that may exist among members of a family. These sanctions may serve as a substitute for legal enforcement.
- Informal moneylenders use specific incentives to stimulate repayment such as repeat lending to borrowers who repay promptly, with gradually increasing loan size.

Despite the fact that many rural poor acquire their loans from the informal financial sector in rural areas of developing countries; the sector has some basic limitations. Common features of many rural communities are that much of the local information does not flow freely; it tends to be segmented and circulates only within specific groups.

### **4.5 Few Schemes of Govt. of India**

There are so many schemes for the upliftment of poor in India. One of them Micro-credit programmes is run primarily by NABARD in the field of agriculture and SIDBI in the field of industry, service and business (ISB). The success of micro-credit programme lies in diversification of services. Micro Finance Scheme of SIDBI is under operation since January, 1999 with a corpus of Rs. 100 crore and a network of about 190 capacity assessed rated MIFs/NGOs. Under the programme, total amount of Rs. 191 crore have been sanctioned upto 31<sup>st</sup> December, 2003, benefiting over 9 lakh beneficiaries. Under the programme, NGOs/MFIs are supposed to provide equity support in order to avail SIDBI finance. But they find it difficult to manage the needed equity support because of this poor financial condition. The problem has got aggravated due to declining interest rate on deposits. The office of the development commissioner (Small Scale Industries) under Ministry of SSI is launching a new scheme of Micro Finance Programme to overcome the constraints in the existing scheme of SIDBI, whose reach is currently very low. It is felt that Government's role can be critical in



expanding reach of the scheme, ensuring long term sustainability of NGOs/MFIs and development of Intermediaries for identification of viable projects.

### **Salient Features of Micro-Finance Programme of Government of India**

- a. Arranging Fixed Deposits for MFIs/NGOs:  
Under this scheme, Government of India arranges money to MFI/NGO like SIDBI for micro credit to poor.
- b. Training and Studies on Micro-Finance Programme:  
Government of India would help SIDBI in meeting the training needs of NGOs, SHGs, intermediaries and entrepreneurs and also in enhancing awareness about the programme. Institution building for 'Intermediaries' for identification of viable projects: the Govt. of India would help in institution building through identification and development of 'intermediary organisation', which would help the NGOs/SHGs in identification of products, preparation of project report, working out forward and backward linkage and in fixing marketing/technology tie-ups. The SISIs would help in the identification of such intermediaries in different areas.
- c. Budgetary Provision for the Scheme During 10<sup>th</sup> Plan:  
There was a budgetary provision in 10<sup>th</sup> five year plan and hoping more funds in next plan.
- d. Administrative arrangement:  
A committee has been formed to control and monitor the administrative arrangement of MFI/NGOs.

### **5. CONCLUSION**

Microcredit and Microfinance have received extensive recognition as a strategy for poverty reduction and for economic empowerment. From the above study we can say that microfinance is a way for fighting poverty, particularly in rural areas, where most of the world's poorest people live. Rural development and poverty reduction are commonly related to the issue of rural employment. Rural household's livelihood strategies comprise several options, including farming and non-farm activities, local self employment and wage employment and migration. Microfinance has proven to be an effective and powerful tool for rural development and poverty reduction.

### **6. REFERENCES**

1. Ghalib, Asad K. (2007), "Measuring the Impact of Microfinance Intervention: A Conceptual Framework of Social Impact Assessment", *The Singapore Economic Review Conference*.
2. *Benchmarks (2005). Microfinance Information Exchange, Inc. (MIX)*
3. <http://www.microcreditsummit.org/papers/papers.htm>.
4. [www.ssi.ac.in](http://www.ssi.ac.in)
5. <https://www.researchgate.net>
6. <https://www.adb.org>